

EMSKE 40 EMV-S

Ex-EMC-cable gland, brass

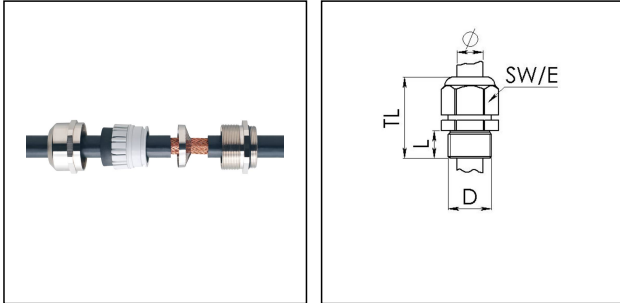

Product illustrations are exemplary and may differ from the chosen product. Further variants and individual customization, we will gladly provide you on request.



Material cable gland	Brass nickel-plated
Material clamping cage	Polyamide
Material sealing gasket	EPDM
Temp. range min	-40 °C
Temp. range max	75 °C
Protection class	IP66/IP68 (5 bar 30 min)
Marking	II 2 D Ex tb IIIC Db IP68, II 2 G Ex e IIC Gb
Approval	IECEX PTB 13.0027X, PTB 04 ATEX 1112 X
Thread type	M
Ø Connection thread D	40
Lead	1,5
Length screw-in thread L	8 mm
Ø cable diameter min	16 mm
Ø cable diameter max	28 mm
Ø cable below cable shield	26 mm
Key width SW	46 mm
Collar diameter (E)	51 mm
Total length TL	44 mm - 55 mm
Install. torques fitting	20 N m
Install. torques cap nut	20 N m
Surface	Nickel-plated
Order no. nickel-plated	10102976
Type	EMSKE 40 EMV-S
Packing unit	10

Recommended accessories

RDE 40	10062187
EMMU-EMV 40	10063215
BS 28	10064016

23.09.2016

