

## EMSKE 50 EMV-S

Ex-EMC-cable gland, brass

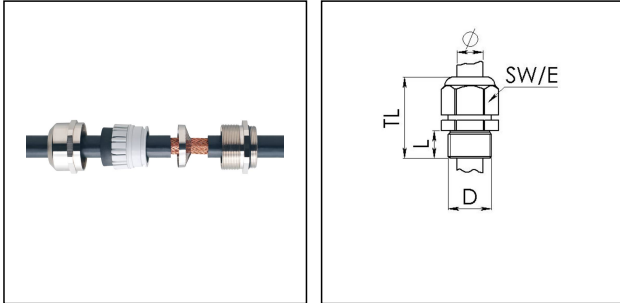

Product illustrations are exemplary and may differ from the chosen product. Further variants and individual customization, we will gladly provide you on request.



Material cable gland	Brass nickel-plated
Material clamping cage	Polyamide
Material sealing gasket	EPDM
Temp. range min	-40 °C
Temp. range max	75 °C
Protection class	IP66/IP68 (5 bar 30 min)
Marking	II 2 D Ex tb IIIC Db IP68, II 2 G Ex e IIC Gb
Approval	IECEX PTB 13.0027X, PTB 04 ATEX 1112 X
Thread type	M
Ø Connection thread D	50
Lead	1,5
Length screw-in thread L	9 mm
Ø cable diameter min	21 mm
Ø cable diameter max	35 mm
Ø cable below cable shield	33 mm
Key width SW	55 mm
Collar diameter (E)	61 mm
Total length TL	51 mm - 62 mm
Install. torques fitting	30 N m
Install. torques cap nut	30 N m
Surface	Nickel-plated
Order no. nickel-plated	10102977
Type	EMSKE 50 EMV-S
Packing unit	10

Recommended accessories

<b>RDE 50</b>	10062188
<b>EMMU-EMV 50</b>	10063216
<b>BS 35</b>	10064017

23.09.2016

