

CM-ENS



(DE) Betriebs- und Montageanleitung

Niveauüberwachungsrelais, CM Reihe

Hinweis: Diese Betriebs- und Montageanleitung enthält nicht sämtliche Detailinformationen zu allen Typen der Produktreihe und kann auch nicht jeden Einsatzfall der Produkte berücksichtigen. Alle Angaben dienen ausschließlich der Produktbeschreibung und sind nicht als vertraglich vereinbarte Beschaffenheit aufzufassen. Weiterführende Informationen und Daten erhalten Sie in den Katalogen und Datenblättern der Produkte, über die örtliche ABB-Niederlassung sowie auf der ABB Homepage unter www.abb.com. Technische Änderungen jederzeit vorbehalten. In Zweifelsfällen gilt der deutsche Text.



Warnung! Gefährliche Spannung! Installation nur durch elektrotechnische Fachkraft. Landes-spezifische Vorschriften (z.B. VDE, etc.) beachten. Vor der Installation diese Betriebs- und Montageanleitung sorgfältig lesen und beachten. An die nicht beschrifteten Klemmen darf kein Leiter angeschlossen werden.

(EN) Operating and installation instructions

Liquid level monitoring relays, CM range

Note: These operating and installation instructions cannot claim to contain all detailed information of all types of this product range and can even not consider every possible application of the products. All statements serve exclusively to describe the product and have not to be understood as contractually agreed characteristics. Further information and data is obtainable from the catalogues and data sheets of this product, from the local ABB sales organisations as well as on the ABB homepage www.abb.com. Subject to change without prior notice. The German text applies in cases of doubt.



Warning! Hazardous voltage! Installation by person with electrotechnical expertise only and in accordance with the specific national regulations (e.g., VDE, etc.). Before installing this unit, read these operating and installation instructions carefully and completely. Do not connect any conductor to terminals not labelled.

(FR) Instructions de montage et de mise en service

Relais de contrôle de niveau de liquide, gamme CM

Note: Ces instructions de service et de montage ne contiennent pas toutes les informations relatives à tous les types de cette gamme de produits et ne peuvent pas non plus tenir compte de tous les cas d'application. Toutes les indications ne sont données qu'à titre de description du produit et ne constituent aucune obligation contractuelle. Pour de plus amples informations, veuillez-vous référer aux catalogues et aux fiches techniques des produits, à votre agence ABB ou sur notre site www.abb.com. Sous réserve de modifications techniques. En cas de divergences, le texte allemand fait foi.



Avertissement! Tension électrique dangereuse! Installation uniquement par des personnes qualifiées en électrotechnique et en conformité avec les prescriptions nationales (p.e. VDE, etc.). Avant l'installation de cet appareil veuillez lire l'intégralité de ces instructions. Ne pas connecter de conducteur aux bornes non marquées.

(ES) Instrucciones de montaje y de servicio

Relés de control de nivel de líquidos, serie CM

Nota: Estas instrucciones no contienen todas las informaciones detalladas relativas a todos los tipos del producto ni pueden considerar todos los casos de operación. Todas las indicaciones son a título descriptivo del producto y no constituyen ninguna obligación contractual. Para más información, consulte los catálogos, las hojas de características, la sucursal local de ABB o la Web www.abb.com. Sujeto a cambios técnicos sin previo aviso. En caso de duda, prevalece el texto alemán.



¡Advertencia! ¡Tensión peligrosa! La instalación deberá ser realizada únicamente por electricistas especializados. Es necesario respetar las normas específicas del país (p.ej. VDE, etc.). Antes de la instalación lea completamente estas instrucciones. No conectar ningún conductor a los bornes no marcados.

(IT) Istruzioni per l'uso ed il montaggio

Relè di controllo del livello di liquidi, serie CM

Nota: Le presenti istruzioni per l'uso ed il montaggio non contengono tutte le informazioni di dettaglio sull'intera gamma di prodotti e non possono trattare tutti i casi applicativi. Tutte le indicazioni servono esclusivamente a descrivere il prodotto e non costituiscono alcuna obbligazione contrattuale. Per ulteriori informazioni consultare i cataloghi ed i data sheet dei prodotti, o la nostra homepage www.abb.com, oppure rivolgersi alla filiale locale di ABB. Ci riserviamo il diritto di effettuare eventuali modifiche tecniche. In caso di discrepanze o fraintendimenti fa fede il testo in lingua tedesca.



Avvertenza! Tensione pericolosa! Far installare solo da un elettricista specializzato. Bisogna osservare le specifiche norme nazionali p.e. VDE, etc.). Prima dell'installazione leggere attentamente le seguenti istruzioni. Non collegare nessun conduttore ai morsetti non marcati.

(RU) Инструкция по установке и эксплуатации

Реле контроля уровня жидкости, серия CM

Примечание: Настоящая инструкция по установке и эксплуатации не претендует на полноту содержащейся здесь информации по всем типам изделий серии и не рассматривает все возможности применения настоящего изделия. Вся информация служит исключительно для его описания и не должна рассматриваться в качестве гарантированных характеристик, имеющих юридическую силу. Дополнительную информацию и данные можно получить из каталогов и листа тех. данных на настоящее изделие в местном представительстве компании ABB, а также на сайте компании ABB по адресу: www.abb.com. Возможны изменения без предварительного уведомления. При возникновении сомнений текст на немецком языке имеет приоритет.



Осторожно! Опасное напряжение! Монтаж должен выполняться только специалистом-электриком в соответствии с нормативным законодательством (т.к. VDE, итд). Перед установкой элемента внимательно ознакомьтесь с инструкцией. Не подключайте провода к клеммам, не имеющий обозначений.

(ZH) 操作与安装指南

液位监视继电器, CM系列

注意: 本操作指南不包含技术数据和全部应用说明, 所有数据只是具有对产品特性进行说明的作用, 因此不具备法律效应。详细说明请参阅技术样本或联络ABB当地办事处或浏览ABB网站 (www.abb.com)。如有更改恕不通知。并以德文为标准。

警告! 危险电压! 仅可由电气专业人员安装且需符合特定的国家规定 (如VDE等)。安装前, 请仔细且全部阅读该安装说明。无标识的端子不可接线。

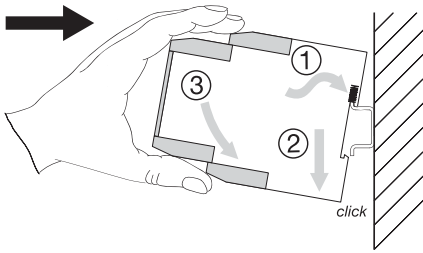

2CDC 253 012 F0014

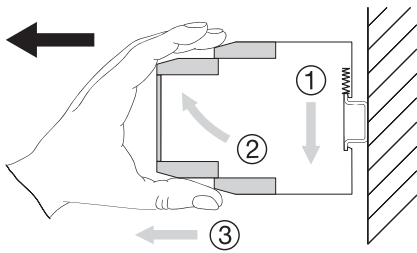

2CDC 253 013 F0014

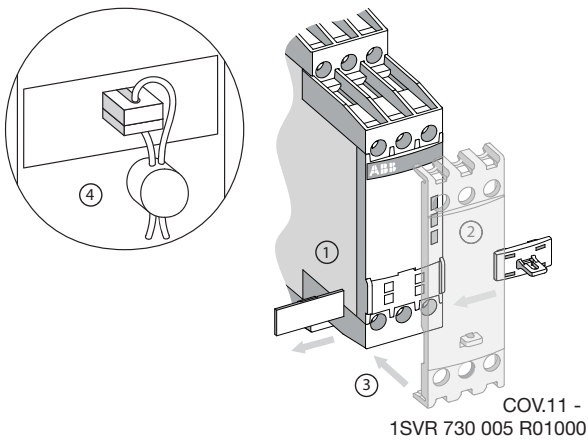

2CDC 253 024 F0014

CM-ENS.xyS

CM-ENS.xyP

DIN ISO 2380-1 Form A 0.8 x 4 mm / 0.0315 x 0.157 in DIN ISO 8764-1 PZ 1 Ø 4.5 mm / 0.177 in	 0.6...0.8 Nm 7.08 lb.in	
 8 mm 0.315"	1 x 0.5...4.0 mm ² 2 x 0.5...2.5 mm ² 1 x 20...12 AWG 2 x 20...14 AWG	2 x 0.5...1.5 mm ² 2 x 20...16 AWG
 8 mm 0.315"	1 x 0.5...2.5 mm ² 2 x 0.5...1.5 mm ² 1 x 18...14 AWG 2 x 18...16 AWG	2 x 0.5...1.5 mm ² 2 x 18...16 AWG
 8 mm 0.315"	1 x 0.5...2.5 mm ² 2 x 0.5...1.5 mm ² 1 x 18...14 AWG 2 x 18...16 AWG	2 x 0.5...1.5 mm ² 2 x 18...16 AWG
DIN 46228-1-A DIN 46228-4-E		

2CDC 252 014 F0015

CONNECT (IN)		
DISCONNECT (OUT)		

2CDC 253 007 F0011

Technical data:

T_a: -25 ... +60 °C (-13 ... +140 °F)

IP 20

Pollution degree 3

I Examples:

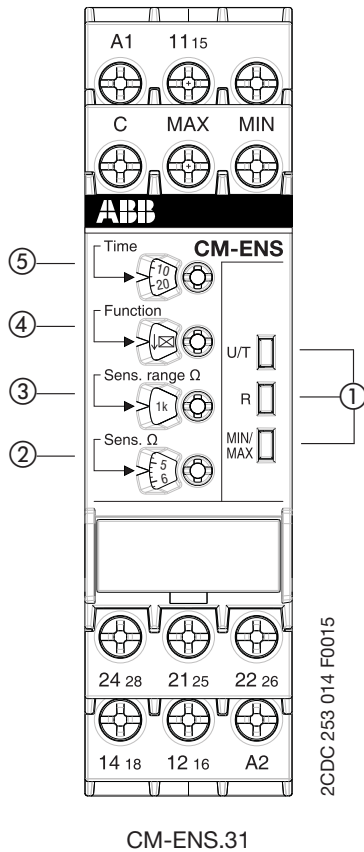
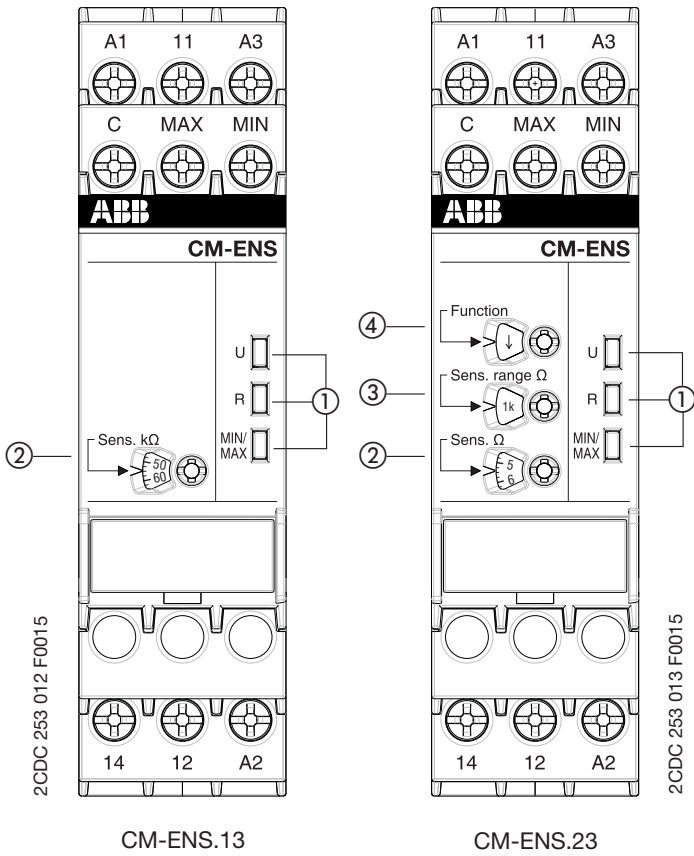

II Function diagrams

a) CM-ENS.1x, CM-ENS.2x: Drain

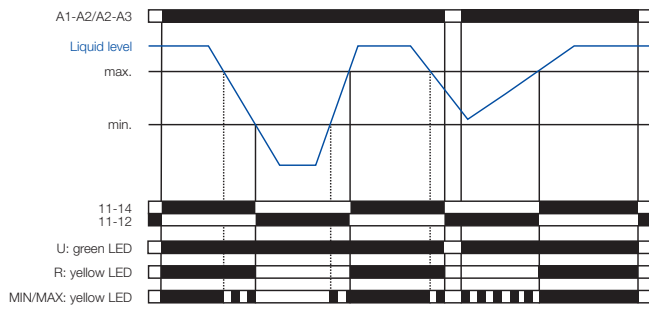

2CDC 252 004 F0015

b) CM-ENS.2x: Fill

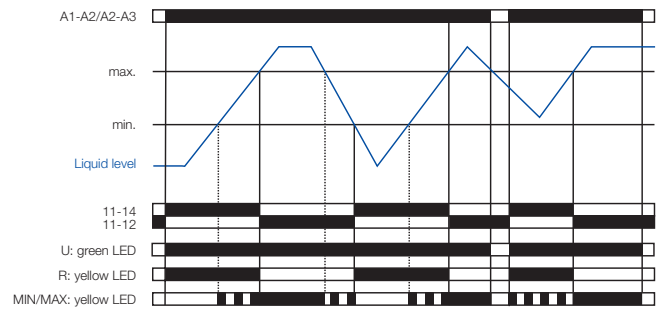

2CDC 252 003 F0015

c) CM-ENS.31: Drain

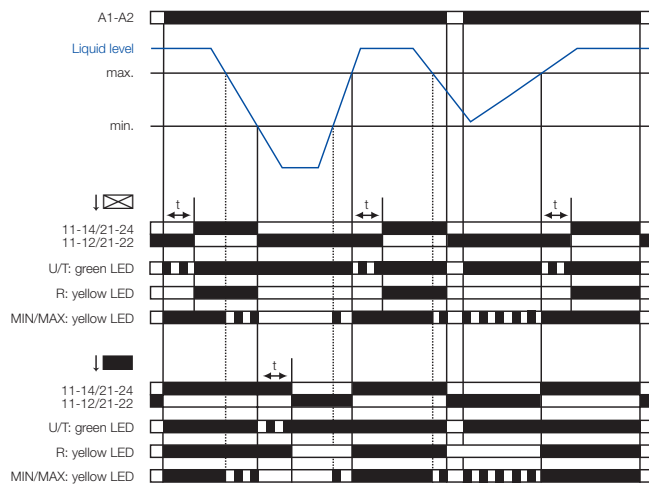





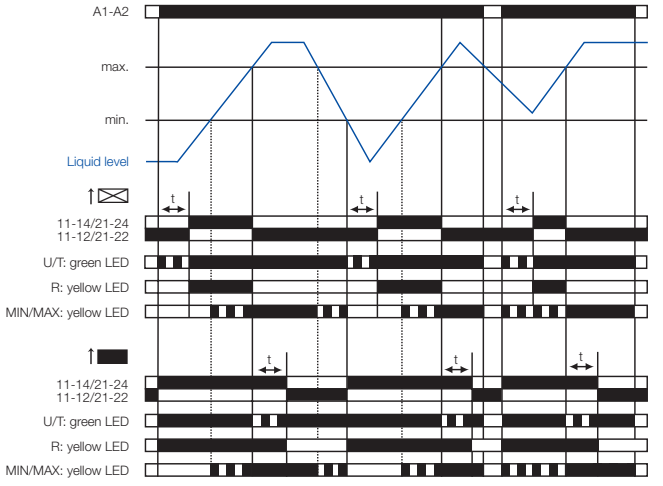



2CDC 252 002 F0015

d) CM-ENS.31: Fill



2CDC 252 001 F0015

I Frontansicht mit Bedienelementen

- ① Betriebszustandsanzeige mit LEDs
 U(T): LED grün - Anzeige Steuerspeisespannung und Zeitablauf
 Steuerspeisespannung liegt an
 Verzögerungszeit aktiv
- R: LED gelb - Anzeige der Schaltstellung der Ausgangsrelais
 angezogen
- MIN/MAX: LED gelb - Anzeige Zustand der Elektroden
 MIN und MAX benetzt
 MIN benetzt
- ② Einstellung des Widerstandsansprechwertes
 ③ Vorwahl des Widerstandsbereiches (nur CM-ENS.2x und 31)
 ④ Wahlschalter Funktion (je nach Gerät)
 ↑ Befüllen
 ↓ Entleeren
 ↑  Befüllen, ansprechverzögert
 ↑  Befüllen, rückfallverzögert
 ↓  Entleeren, ansprechverzögert
 ↓  Entleeren, rückfallverzögert
- ⑤ Einstellung der Verzögerungszeit (nur CM-ENS.31)

Elektrischer Anschluss



Bemessungsspeisespannung dem seitlichen Typenschild am Gerät entnehmen.

A1-A2; A2-A3	Steuerspeisespannung U_s
11-12/14	Ausgangsrelais
11 ₁₅ -12 ₁₆ /14 ₁₈	Ausgangsrelais
21 ₂₅ -22 ₂₆ /24 ₂₈	Ausgangsrelais

Elektrodenanschlüsse

C	Bezugselektrode
MIN	Elektrode Minimalniveau
MAX	Elektrode Maximalniveau

Achtung:

CM-ENS.x3: Bei Schaltströmen > 2 A ist ein seitlicher Geräteabstand von mindestens 10 mm (0,394 in) einzuhalten.

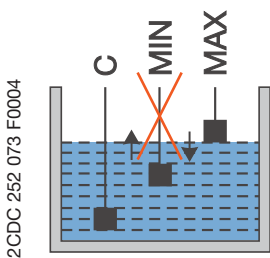









Die Niveauüberwachungsrelais CM-ENS können auch mit 2 Elektroden C und MAX betrieben werden. Die Ausgangsrelaiskontakte schalten dann nur um den Füllstand MAX.

II Funktionsdiagramme

- a) CM-ENS.1x, CM-ENS.2x: Entleeren
 b) CM-ENS.2x: Befüllen
 c) CM-ENS.31: Entleeren
 d) CM-ENS.31: Befüllen

I Front view with operating controls

- ① Indication of operational states with LEDs
 U(T): green LED - Status indication of control supply voltage and timing
 control supply voltage applied
 time delay is running
- R: yellow LED - Status indication of the output relays
 energized
- MIN/MAX: yellow LED - Status indication of the electrodes
 MIN and MAX wet
 MIN wet
- ② Adjustment of the resistance threshold value
 ③ Preselection of the resistance range (only CM-ENS.2x and 31)
 ④ Function selector switch (depending on device)
 ↑ Fill
 ↓ Drain
 ↑  Fill, ON-delayed
 ↑  Fill, OFF-delayed
 ↓  Drain, ON-delayed
 ↓  Drain, OFF-delayed
- ⑤ Adjustment of the time delay (only CM-ENS.31)

Electrical connection



For the rated control supply voltage, see label at the side of the unit.

A1-A2; A2-A3	Control supply voltage U_s
11-12/14	Output relay
11 ₁₅ -12 ₁₆ /14 ₁₈	Output relay
21 ₂₅ -22 ₂₆ /24 ₂₈	Output relay

Electrode connection

C	Reference electrode
MIN	Minimum level electrode
MAX	Maximum level electrode

Attention:

CM-ENS.x3: In case of switching currents > 2 A, lateral spacing to other units has to be min. 10 mm (0.394 in).

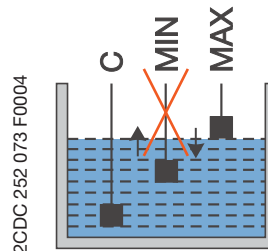









The liquid level monitoring relays CM-ENS can also be operated with 2 electrodes C and MAX only. In this case the output relay contacts switch around the filling level MAX.

II Funktion diagrams

- a) CM-ENS.1x, CM-ENS.2x: Drain
 b) CM-ENS.2x: Fill
 c) CM-ENS.31: Drain
 d) CM-ENS.31: Fill

I Face avant et dispositifs de commande

- ① Indication de fonctionnement par LED
 - U(T): LED verte - Indication de la tension d'alimentation de commande et temporisation
 -  tension d'alimentation de commande appliquée
 -  temporisation en cours
 - R: LED jaune - Indication de l'état des relais de sortie
 -  activé
 - MIN/MAX: LED jaune - Indication de l'état des électrodes
 -  MIN et MAX mouillées
 -  MIN mouillée
- ② Réglage de la valeur seuil de la résistance
- ③ Présélection de la gamme de résistance (seul CM-ENS.2x et 31)
- ④ Commutateur de sélection de la fonction (dépendant de l'appareil)
 - ↑ Remplissage
 - ↓ Vidage
 - ↑  Remplissage, temporisé au travail
 - ↑  Remplissage, temporisé au repos
 - ↓  Vidage, temporisé au travail
 - ↓  Vidage, temporisé au repos
- ⑤ Réglage de la temporisation (seul CM-ENS.31)

Raccordement électrique



Pour la tension assignée d'alimentation de commande voir l'étiquette placée sur le côté du relais

A1-A2; A2-A3	Tension d'alimentation de commande U_s
11-12/14	Relais de sortie
11 ₁₅ -12 ₁₆ /14 ₁₈	Relais de sortie
21 ₂₅ -22 ₂₆ /24 ₂₈	Relais de sortie

Connexion des électrodes

C	Électrode de référence
MIN	Électrode de niveau minimum
MAX	Électrode de niveau maximum

Attention:

CM-ENS.x3: Dans le cas de courant de commutation > 2 A, l'espacement latérale entre deux modules doit être de 10 mm (0,394 in) au minimum.

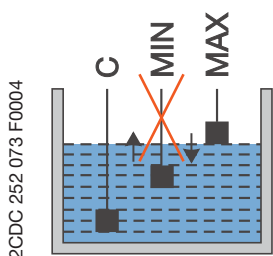









Les relais de surveillance de niveau de liquide CM-ENS peuvent également fonctionner avec 2 électrodes C et MAX seulement. Dans ce cas, la sortie relais sera commutée autour du niveau de remplissage MAX

II Diagrammes de fonctionnement

- a) CM-ENS.1x, CM-ENS.2x: Vidage
- b) CM-ENS.2x: Remplissage
- c) CM-ENS.31: Vidage
- d) CM-ENS.31: Remplissage

I Vista frontal con elementos de mando

- ① Indicadores de servicio con LEDs
 - U(T): LED verde - Indicación tensión de alimentación de mando y temporización
 -  tensión de alimentación de mando aplicada
 -  temporización en curso
 - R: LED amarillo - Indicación del estado de los relés de salida
 -  energizado
 - MIN/MAX: LED amarillo - Indicación del estado de los electrodos
 -  MIN y MAX mojados
 -  MIN mojado
- ② Ajuste del valor umbral de la resistencia
- ③ Preselección del margen de la resistencia (sólo CM-ENS.2x y 31)
- ④ Conmutador de selección de la función (dependiente del dispositivo)
 - ↑ Llenado
 - ↓ Vaciado
 - ↑  Llenado, retardo a la conexión
 - ↑  Llenado, retardo a la desconexión
 - ↓  Vaciado, retardo a la conexión
 - ↓  Vaciado, retardo a la desconexión
- ⑤ Ajuste del tiempo de temporización (sólo CM-ENS.31)

Conexión eléctrica



Véase la etiqueta lateral de características para la tensión nominal de alimentación de mando.

A1-A2; A2-A3	Tensión de alimentación de mando U_s
11-12/14	Relé de salida
11 ₁₅ -12 ₁₆ /14 ₁₈	Relé de salida
21 ₂₅ -22 ₂₆ /24 ₂₈	Relé de salida

Conexión de los electrodos

C	Electrodo de referencia
MIN	Electrodo de nivel mínimo
MAX	Electrodo de nivel máximo

Atención:

CM-ENS.x3: Para corrientes de conmutación > 2 A dejar un espacio lateral entre módulos como mínimo de 10 mm (0,394 in).

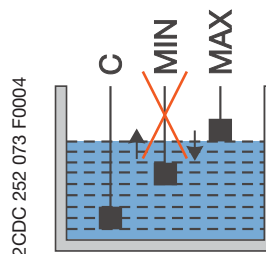









Los relés de vigilancia del nivel de líquidos CM-ENS pueden igualmente funcionar con dos electrodos C y MAX sólo. En ese caso, el relé de salida se conmuta al nivel máximo de llenado.

II Diagramas de funcionamiento

- a) CM-ENS.1x, CM-ENS.2x: Vaciado
- b) CM-ENS.2x: Llenado
- c) CM-ENS.31: Vaciado
- d) CM-ENS.31: Llenado

I Vista frontale con gli elementi di comando

- ① LED di visualizzazione dello stato di funzionamento U(T): LED verde - Indicazione tensione di comando e stato della temporizzazione
-  Tensione di comando applicata
 Temporizzazione in corso
- R: LED giallo - Indicazione dello stato dei relè di uscita
-  eccitato
- MIN/MAX: LED giallo - Indicazione dello stato degli elettrodi
-  MIN e MAX madidos
 MIN madido
- ② Impostazione del valore di soglia per la resistenza
- ③ Preselezione della gamma resistenza (solo CM-ENS.2x e 31)
- ④ Selettore di funzione (a seconda del apparecchio)
- ↑ Riempimento
 ↓ Svuotamento
 ↑  Riempimento, con ritardo all'eccitazione
 ↑  Riempimento, con ritardo alla diseccitazione
 ↓  Svuotamento, con ritardo all'eccitazione
 ↓  Svuotamento, con ritardo alla diseccitazione
- ⑤ Impostazione del tempo di ritardo (solo CM-ENS.31)

Collegamento elettrico



Per la tensione nominale di comando vedi l'etichetta laterale del relè.

A1-A2; A2-A3	Tensione di comando U_s
11-12/14	Relè di uscita
11 ₁₅ -12 ₁₆ /14 ₁₈	Relè di uscita
21 ₂₅ -22 ₂₆ /24 ₂₈	Relè di uscita

Collegamento degli elettrodi

C	Elettrodo di riferimento
MIN	Elettrodo del livello minimo
MAX	Elettrodo del livello massimo

Attenzione:

CM-ENS.x3: Nel caso in cui la corrente di commutazione fosse > 2 A, prevedere uno spazio laterale tra un modulo e l'altro di minimo 10 mm (0,394 in).

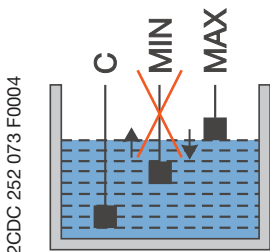









I relè di controllo del livello CM-ENS possono funzionare anche con soli due elettrodi C e MAX. In questo caso i contatti di relè di uscita si inseriscono soltanto con il livello di riempimento MAX.

II Diagrammi di funzionamento

- CM-ENS.1x, CM-ENS.2x: Svuotamento
- CM-ENS.2x: Riempimento
- CM-ENS.31: Svuotamento
- CM-ENS.31: Riempimento

I Вид спереди, органы управления

- ① Индикация состояния Светодиодов (СИД) U(T): зеленый СИД - Индикация состояния напряжения питания и отсчета времени
-  Подано напряжение питания
 Идет отсчет времени задержки
- R: желтый СИД - Индикация состояния выходного реле
-  активировано
- MIN/MAX: желтый СИД - Подано напряжение питания
-  MIN и MAX уровень
 MIN уровень
- ② Регулировка порогового значения сопротивления
- ③ Предварительный выбор диапазона сопротивления (только CM-ENS.2x и 31)
- ④ Преполнитель функций (в зависимости от модели устройства)
- ↑ Заполнение
 ↓ Опорожнение
 ↑  Заполнение, задержка на включение
 ↑  Заполнение, задержка на отключение
 ↓  Опорожнение, задержка на включение
 ↓  Опорожнение, задержка на отключение
- ⑤ Регулировки времени задержки (только CM-ENS.31)

Электрическое подключение



Обратите внимание на маркировку, нанесенную на корпус изделия, для определения напряжения питания

A1-A2; A2-A3	Питающее напряжение U_s
11-12/14	Выходное реле
11 ₁₅ -12 ₁₆ /14 ₁₈	Выходное реле
21 ₂₅ -22 ₂₆ /24 ₂₈	Выходное реле

Подключение электрода

C	Массовый электрод
MIN	Электрод минимального уровня
MAX	Электрод максимального уровня

Внимание:

CM-ENS.x3: В случае коммутации токов > 2 А, боковой интервал до других устройств должно быть мин. 10 мм (0.394 дюймов).

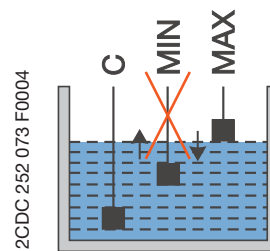

Реле контроля уровня жидкости CM-ENS может использовать только 2 электрода для работы C и MAX. При достижении уровня электрода MAX выходные контакты переключаются.

II Функциональные схемы

- CM-ENS.1x, CM-ENS.2x: Опорожнение
- CM-ENS.2x: Заполнение
- CM-ENS.31: Опорожнение
- CM-ENS.31: Заполнение

I 前面板操作

- ① LED状态指示
- U(T): LED 绿色 - 控制电压和时间的状态显示
-  控制电压上电
 延时开始
- R: LED 黄色 - 输出继电器的状态显示
-  动作
- MIN/MAX: LED 黄色 - 电极的状态显示
-  MIN和MAX接触液体
 MIN接触液体
- ② 电阻阈值的调节
- ③ 电阻范围的预选 (仅CM-ENS.2x和31)
- ④ 功能选择开关 (取决于模块)
- ↑ 注入液体
 ↓ 排出液体
 ↑  注入液体延时
 ↑  注入液体停止延时
 ↓  排出液体延时
 ↓  排出液体停止延时
- ⑤ 延时时间调节 (仅CM-ENS.31)

电气连接



额定控制电压，参见模块侧面的标签。

A1-A2; A2-A3	控制电压 U_s
11-12/14	输出继电器
11 ₁₅ -12 ₁₆ /14 ₁₈	输出继电器
21 ₂₅ -22 ₂₆ /24 ₂₈	输出继电器

电极连接

C	参考电极
MIN	最低液位电极
MAX	最高液位电极

注意:

CM-ENS.x3: 若开关电流 >2 A, 模块之间横向的安装间距应大于等于10 mm (0.394 in)。

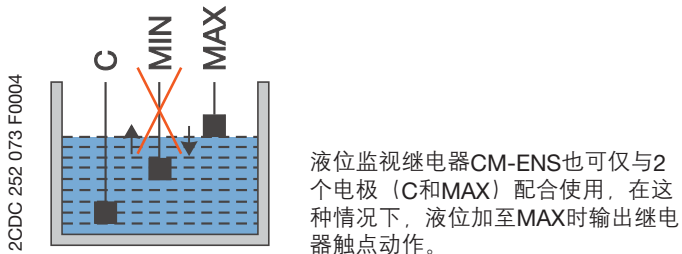

II 功能图

- CM-ENS.1x, CM-ENS.2x: 排出液体
- CM-ENS.2x: 注入液体
- CM-ENS.31: 排出液体
- CM-ENS.31: 注入液体