

DOSATec LMS

INSTALLATION MANUAL **EN**

HANDBUCH **DE**

MANUAL DE INSTALACION **ES**

MANUEL D'INSTALLATION **FR**

MANUALE D'INSTALLAZIONE **IT**

MANUAL DE INSTALAÇÃO **PT**

KULLANIM KLAVUZU **TR**

РУКОВОДСТВО ПО УСТАНОВКЕ И ЭКСПЛУАТАЦИИ **RU**





Control panel – DOSATec LMS



	Access to the programming menu
	When pressed during the pump operation phase, it cyclically displays the programmed values on the display; When pressed at the same time or keys, it increases or decreases a value dependent on the selected operating mode. During programming it carries out an “enter” function, meaning that it confirms entry to the various menu levels and modifications within the same.
	Starts and stops the pump. In the event of a level alarm (alarm function only), flow alarm and active memory alarm, it deactivates the signal on the display.
	Used to “exit” the various menu levels. Before definitively exiting the programming phase, you will be asked if you wish to save any changes
	Used to run upwards through the menu or increase the numerical values to be changed. Can be used to start dosage in Batch mode
	Used to run downwards through the menu, or decrease the numerical values to be changed.
	Flashing green LED during dosage
	Red LED that lights up in various alarm situations

Electrical connections

	1	Alarm relay	
	2		
	3	Pole +	4-20 mA input signal Input Impedante: 200 ohm
	4	Pole -	
	5	-Remote control input (start-stop)	
	6	-Pause signal input	
	7	-Frequency signal input (water-meter pulse-sender)	
	8	-Trigger signal input	
	9	Flow sensor input	
	10		
B	Input level control		

You can access the programming menu by pressing the  key for over three seconds. The   keys can be used to run through the menu items, with the  key being used to access changes. The pump is programmed in constant mode in the factory. The pump automatically returns to the operating mode after 1 minute of no activity. Any data entered in these circumstances will not be saved.

The  key can be used to exit the various programming levels. Upon exiting programming, the display will show:

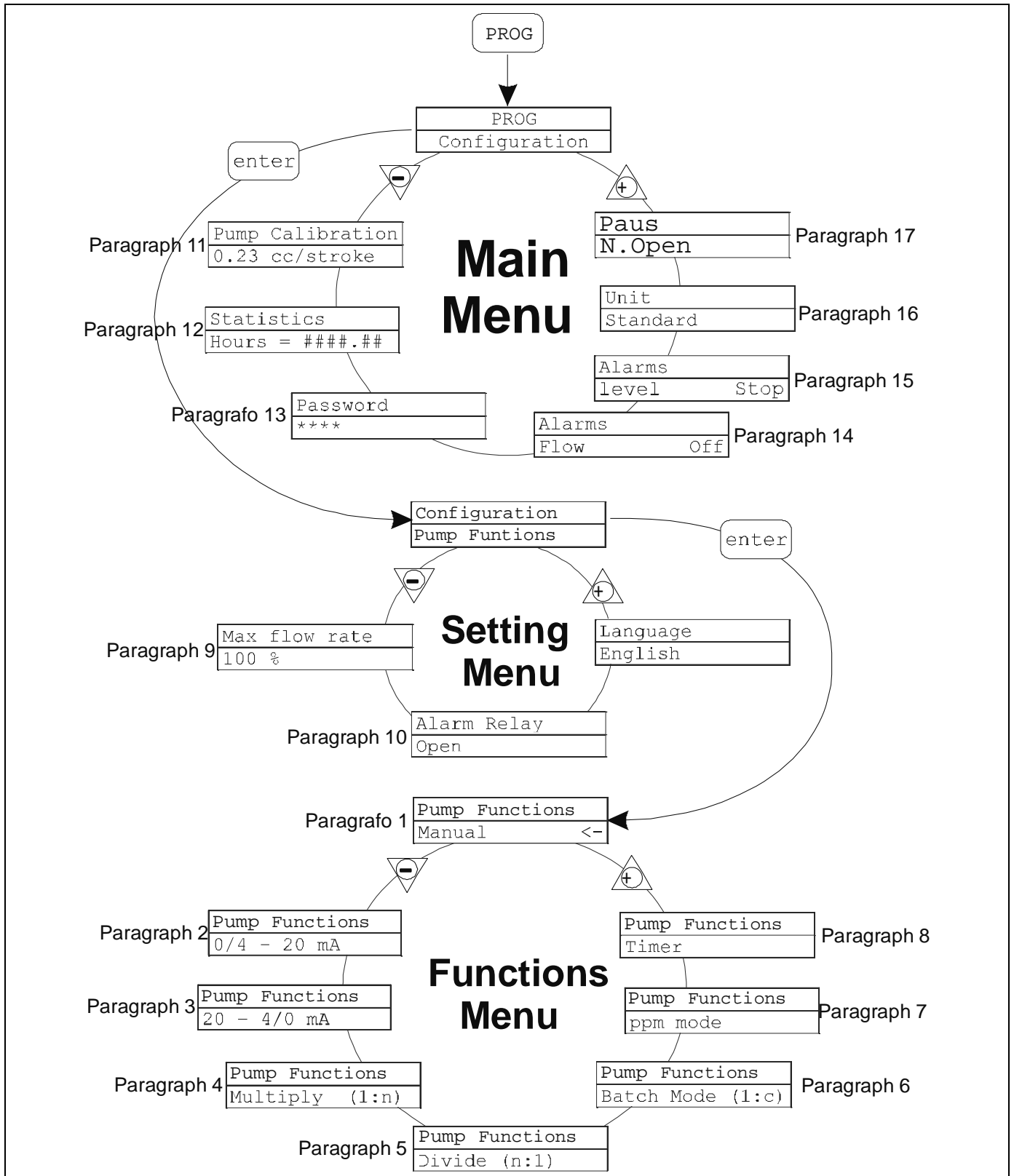
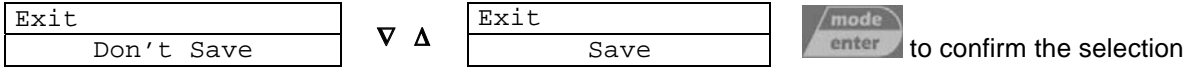

Setting the Language

Programming	Operation
<pre> graph TD A[PROG] --> B[PROG Configuration] B -- enter --> C[Configuration Pump Functions] C --> D[Max flow rate P100%] D --> E[Alarm Relay N.Open] E --> F[Language English] F -- enter --> G[] F --> H[] H --> I[] G --> I </pre>	<p>Makes it possible to select the language. The pump is set in English in the factory.</p> <p>Changes can be made by pressing the key, then using the keys to set the new value. Press to confirm and return to the main menu</p>

Paragraph 1 – Manual Dosage

Programming	Operation
<pre> graph TD A[PROG] --> B[PROG Configuration] B -- enter --> C[Configuration Pump Functions] C -- enter --> D[Pump Functions Manual <-] D -- enter --> E[] </pre>	<p>The pump operates in constant mode. The flow can only be manually regulated by pressing the keys at the same time to increase the flow, or the keys to decrease it.</p>

Display during Operation	Display during Setting (MODE key)
<p>Operating mode</p> <ul style="list-style-type: none"> Man = Manual <p>FLOW sensor status</p> <p>Current dosage speed (depends on selected unit of measurement)</p> <ul style="list-style-type: none"> Percentage, Frequency, l/h, Gph, ml/m <p>Alarms and statuses</p> <ul style="list-style-type: none"> Lev = Level alarm Flw = Flow alarms <p>Pump status</p> <ul style="list-style-type: none"> Empty = pump in start Stop = pump stationary Paus = pump in pause <p>Display: MAN F Lev Stop P100%</p>	<p>Operating mode</p> <ul style="list-style-type: none"> Man (during manual modification of the flow it displays the corresponding frequency value) <p>Display: MAN P100%</p> <p>Current dosage value</p> <ul style="list-style-type: none"> Modify the maximum flow by pressing the + or - keys at the same time

Paragraph 2 - Dosage Proportional to Signal 0/4-20

Programming	Operation
<pre> graph TD A[PROG] --> B[PROG Configuration] B -- enter --> C[Configuration Pump Functions] C -- enter --> D[Pump Functions 0/4 - 20 mA <-] D -- enter --> E[0/4 - 20 mA Low 4.0mA] E -- enter --> F[0/4 - 20 mA High 20.0mA] F -- enter --> G[] </pre>	<p>The pump proportionally doses at a signal of (0)4-20 mA. On the basis of the factory settings, the pump interrupts dosage at 4mA and doses at the maximum set frequency when it receives 20 mA. These two values can be modified during programming. The maximum frequency can be modified during operation, by pressing the keys at the same time to increase the flow, or the keys to decrease it.</p>

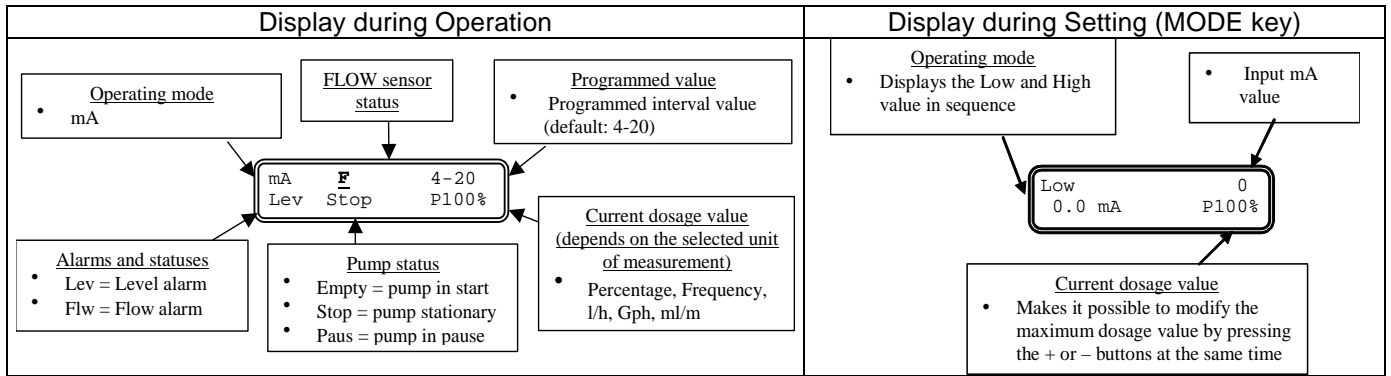

Paragraph 3 - Dosage Proportional to Signal 20-4/0 mA

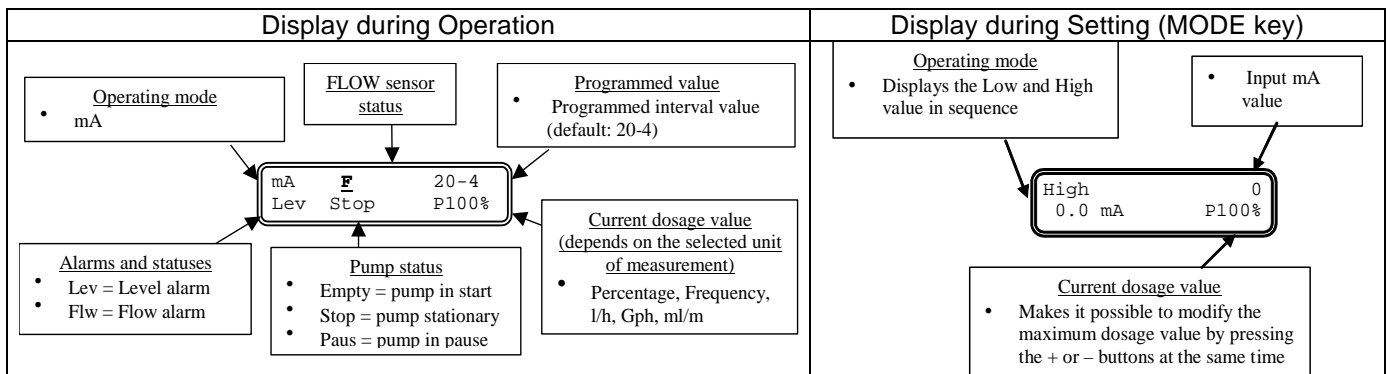
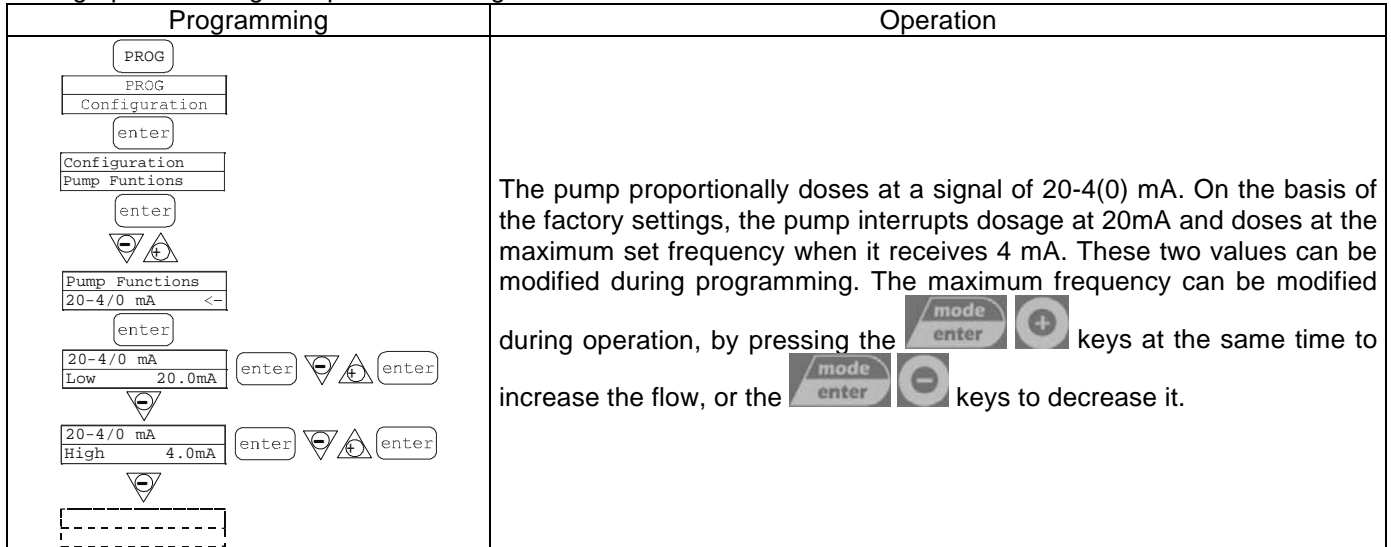

Paragraph 4 – Proportional to External Impulses (multiplication)

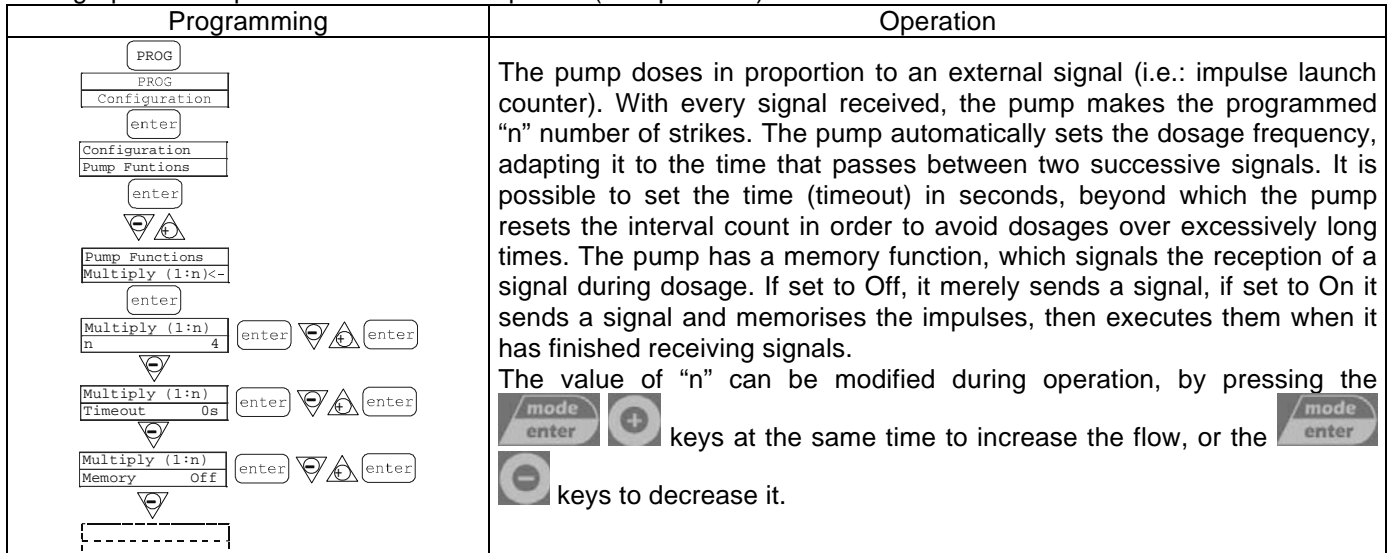

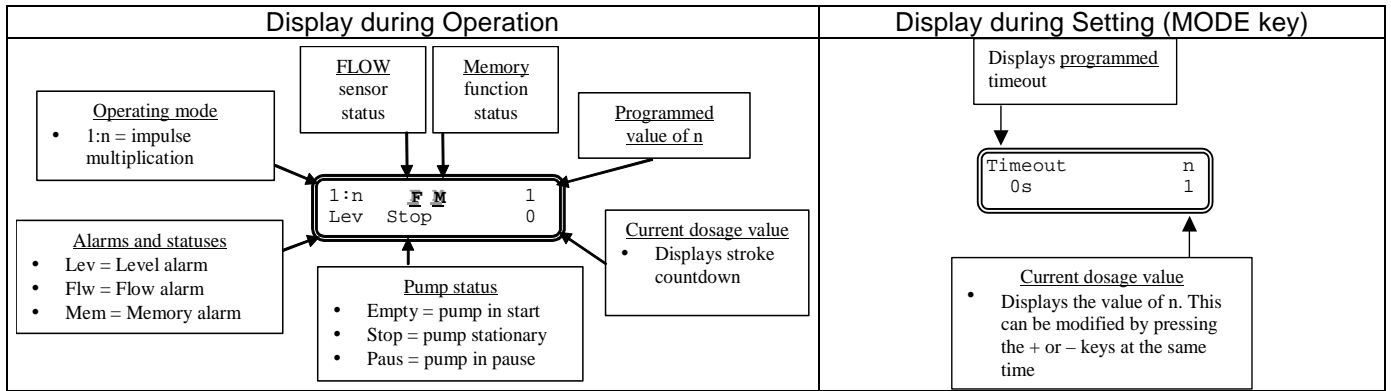

Paragraph 5 – Proportional to External Impulses (division)

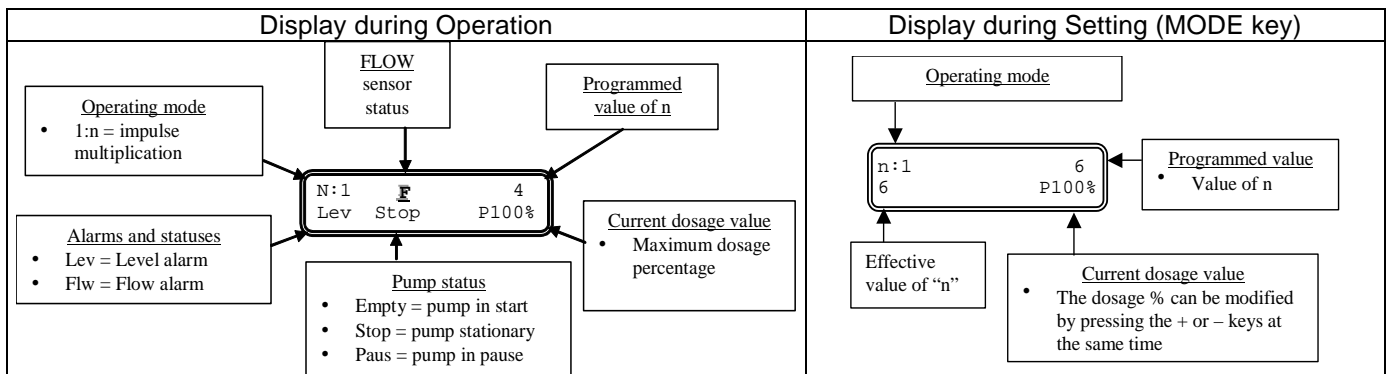
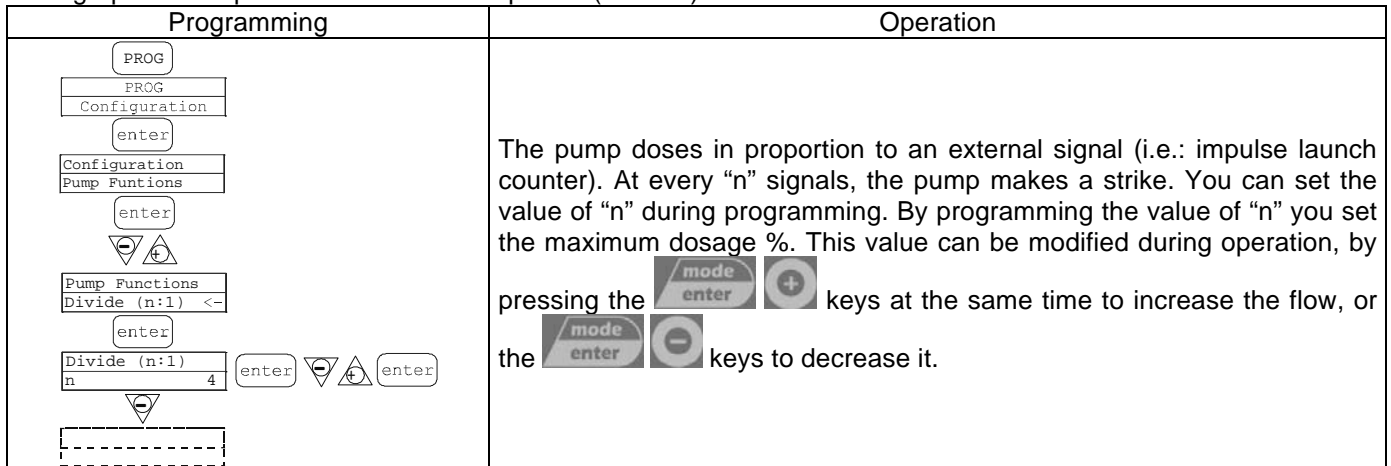

Paragraph 6 – Proportional to External Impulses (batch dosage)

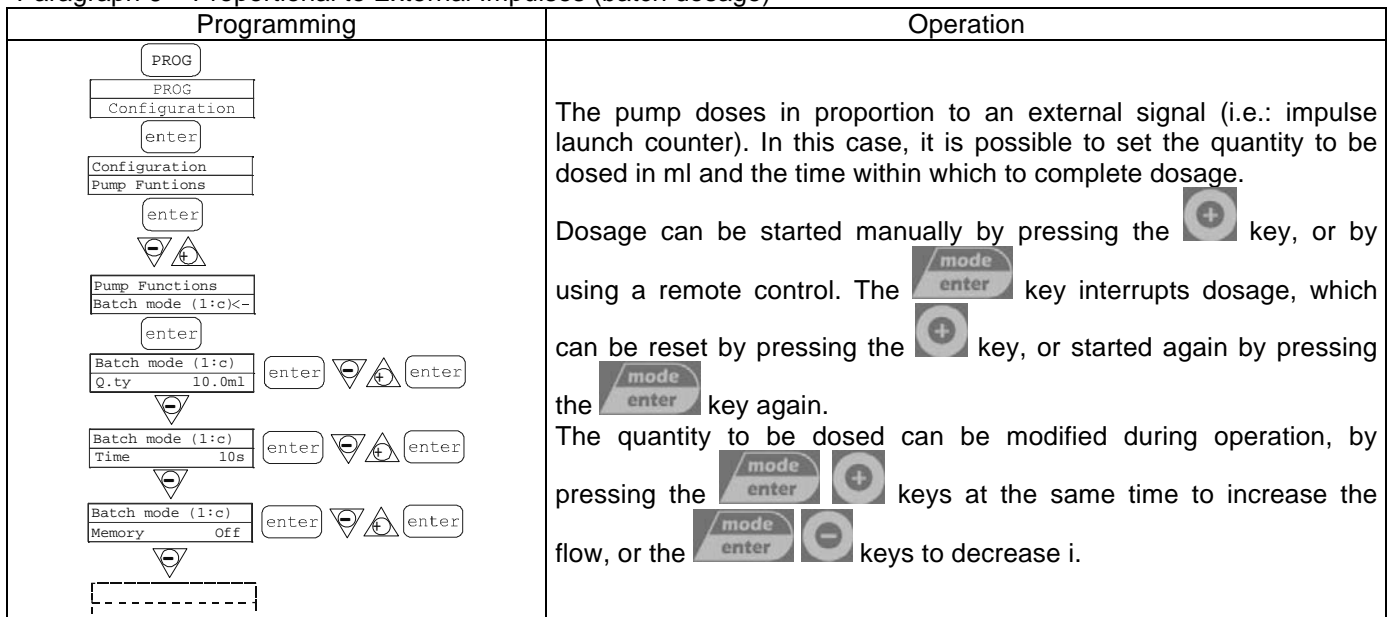

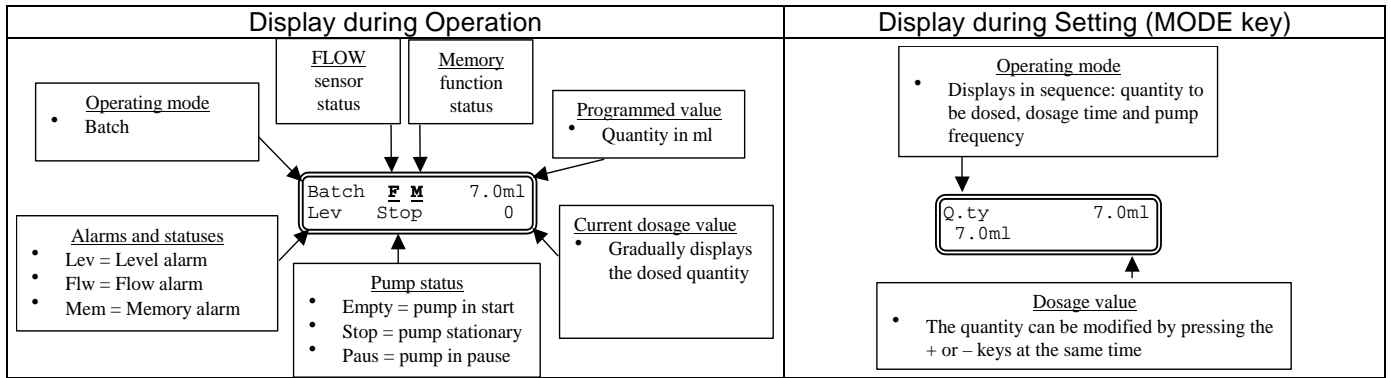

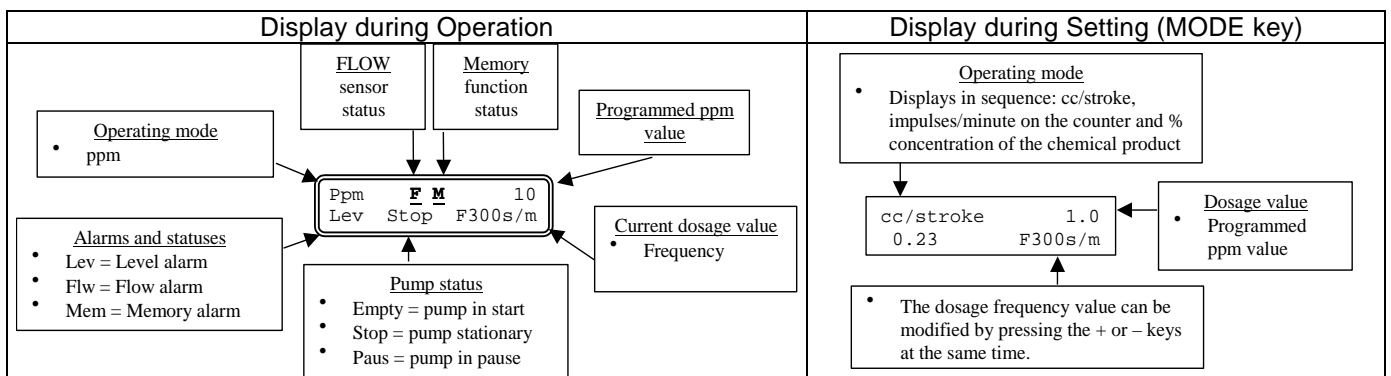
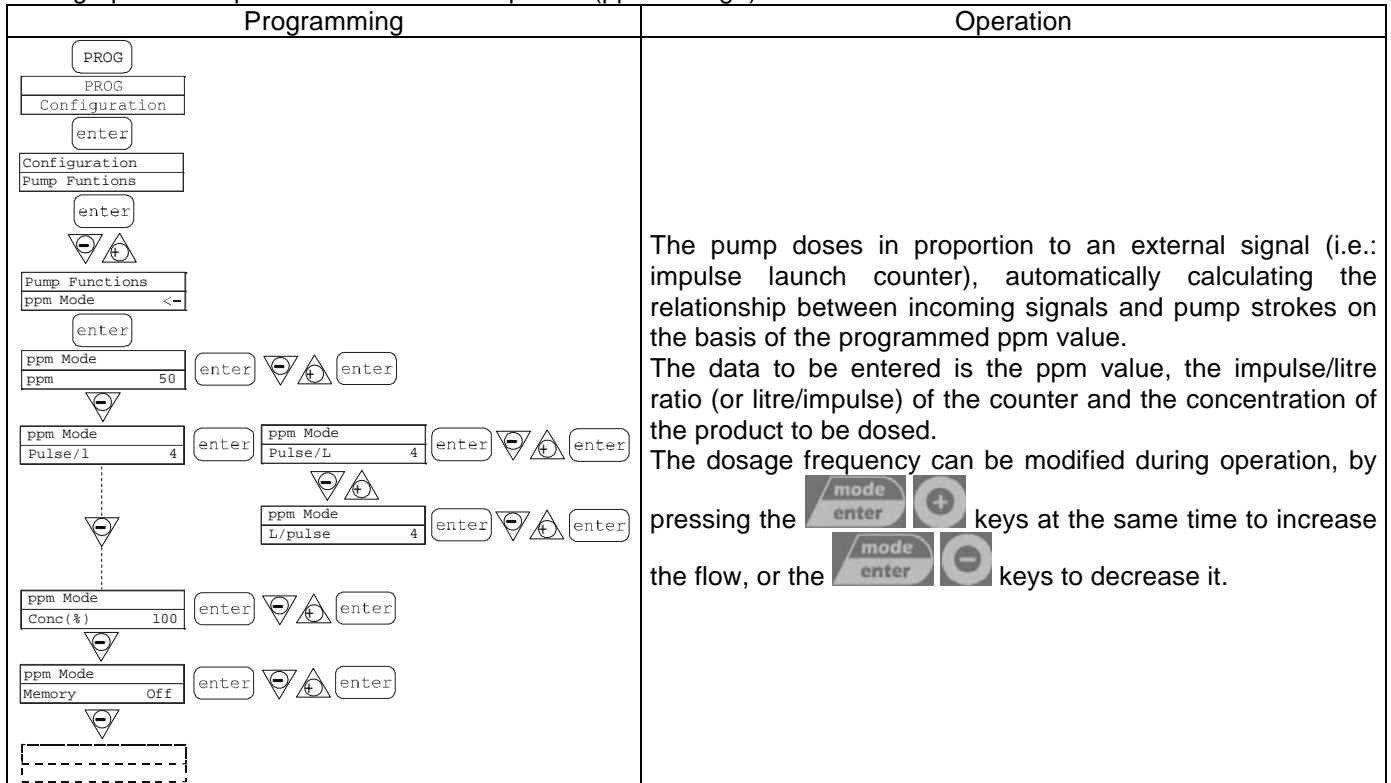

Paragraph 7 – Proportional to External Impulses (ppm dosage)



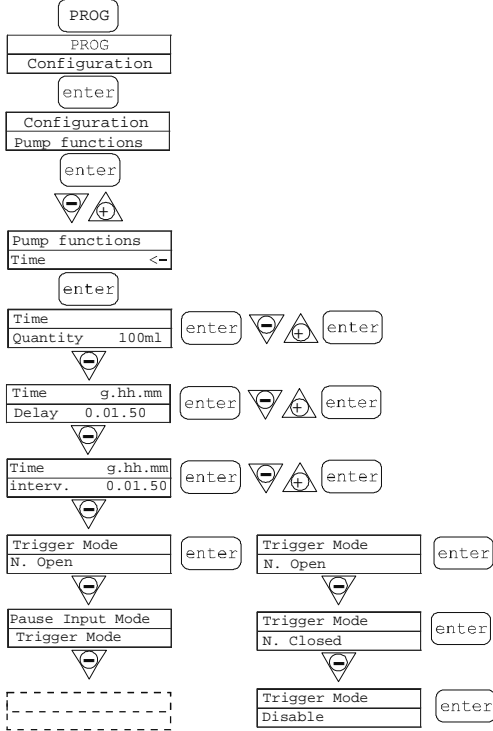
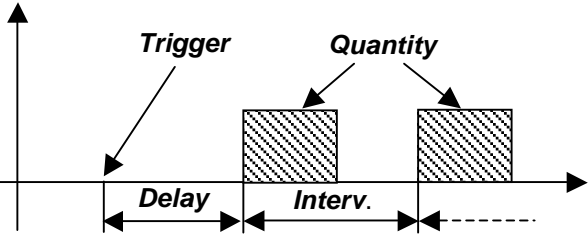
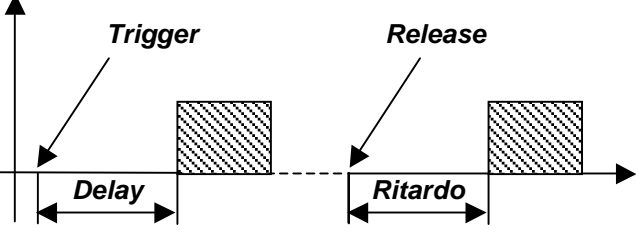

Paragraph 8 – Timed Dosage (**Frequency signal input “TRIGGER” activated**)

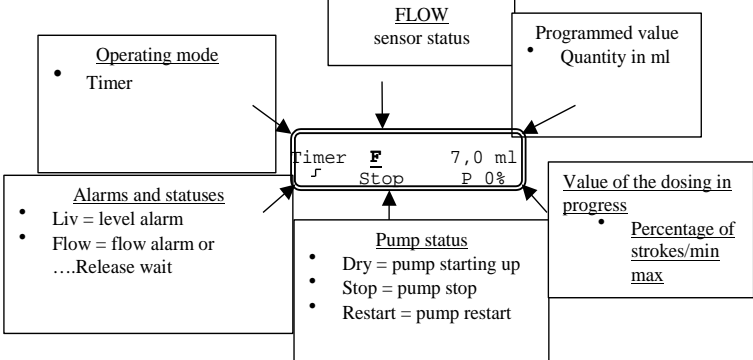
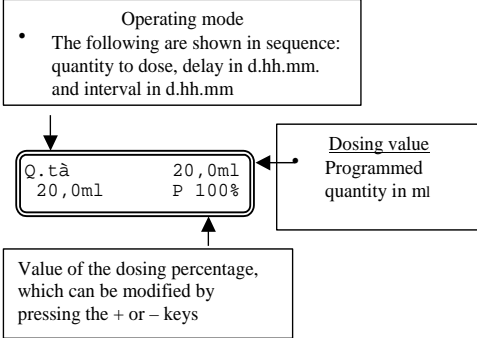
Programming	Operation
	<p>After receipt of the TRIGGER signal set, the pump doses a quantity that can be programmed in ml. It is possible to set a delay time before the dosing (Delay) and the interval between subsequent dosings (Interv.) as illustrated in the diagram:</p>  <p>By setting for example an Interval time = 0, a system is obtained in which the programmed quantity is dosed after each TRIGGER signal (with any delay that has been set):</p>  <p>It is possible to start the dosing by pressing the + key, which, in practice, simulates the Trigger signal. The Trigger signal can be set to N. Open (it is activated when the input passes from the open to the closed mode) or to N. Closed (it is activated when the input passes from the closed to the open mode). The Trigger signal is locked during dosing (its receipt is neither stored nor managed). The Pause (Remote input) input cannot be programmed and its activation stops the dosing, while its further deactivation makes the system wait again for the Trigger signal for a new dosing.</p> <p>The dosage frequency can be modified while the pump is operating, by pressing the  keys at the same time to increase the frequency, or the  keys to decrease it.</p>



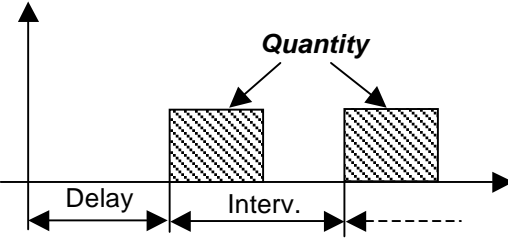

Display during Operation	Display during Setting (MODE key)
	

Paragraph 8 – Timed Dosage (Frequency signal input “TRIGGER” not activated)

Programming	Operation
<pre> PROG PROG Configuration enter Configuration Pum functions enter Pum functions Tempo <- enter Time Quantity 100ml enter Time g.hh.mm Delay 0.01.50 enter Time g.hh.mm Interval 0.01.50 enter Trigger Mode Disable enter Pause Input Mode Restart Timer enter Pause Input Mode Restart Timer enter Pause Input Mode Freeze Time enter Pause Input Mode Pause Dosing enter </pre>	<p>The pump doses a programmed quantity in ml. It is possible to set a pump delay time (Delay) when the pump is started and an interval between two successive dosings (Interval), as illustrated in the diagram:</p>  <p>The Delay and Interval times are in dd.hh.mm (days, hours, minutes)</p> <p>The Pause input can be programmed in three different modes:</p> <ol style="list-style-type: none"> 1. FreezeTime: when the pause is activated, the system cuts out the current time count and restarts it when the pause is deactivated. 2. Pause Dosing: with the pause activated, the system continues to count time and stops the dosing. 3. Restart Timer: when the pause is activated, the system stops the dosing and when the pause is deactivated the count starts again from the beginning. <p>The dosage frequency can be modified while the pump is operating, by pressing the  keys at the same time to increase the frequency, or the  keys to decrease it.</p>

Display during Operation	Display at start-up (MODE key)
<p>Operating mode</p> <ul style="list-style-type: none"> • Timer <p>ALARMS</p> <ul style="list-style-type: none"> • Alarms and Level statuses = level alarm • Flow = flow alarm <p>Timer</p> <pre> Timer F 7.0 ml Liv Stop P 0% </pre> <p>FLOW sensor status</p> <p>Programmed value</p> <ul style="list-style-type: none"> • Quantity in ml <p>Value of dosing in progress:</p> <ul style="list-style-type: none"> • Percentage of strokes/min max <p>Pump status</p> <ul style="list-style-type: none"> • Dry = pump starting up • Stop = pump stopping • Restart = pump restarting 	<p>Modalità di funzionamento</p> <ul style="list-style-type: none"> • Vengono visualizzati in sequenza: quantità da dosare, ritardo in g.hh.mm e intervallo in g.hh.mm <p>Valore del dosaggio</p> <ul style="list-style-type: none"> • Quantità programmata in ml <pre> Q. tà 20.0ml P 100% </pre> <p>Valore della percentuale di dosaggio, modificabile premendo sui tasti + o -</p>

Paragraph 9 – Setting the Maximum Flow

Programming	Operation
<pre> PROG PROG Configuration enter Configuration Pump Functions enter Max flow rate P100% enter Max flow rate P100% enter Max flow rate F320s/m enter </pre>	<p>This makes it possible to set the maximum flow offered by the pump, and the programmed mode (% or frequency) is used as the standard unit of measurement when displaying the flow. Changes can be made by pressing the  key, then using the   keys to set the new value. Press  to confirm and return to the main menu</p>

Paragraph 10 – Setting the Alarm Relay

Programming	Operation
	<p>In the absence of an alarm situation, it can be set as open (default) or closed.</p> <p>Changes can be made by pressing the key, then using the keys to set the new value. Press to confirm and return to the main menu</p>

Paragraph 11 – Flow Calibration

Programming	Operation
	<p>The memorized cc value per strike appears in the main menu. It can be calibrated in two different ways:</p> <p>MANUAL – manually enter the cc value per strike using the keys and confirm by pressing the key</p> <p>AUTOMATIC – the pump makes 100 strikes, which are started by pressing the key. At the end of this process, enter the quantity sucked up by the pump using the keys and confirm by pressing the key. The entered figure will be used in flow calculations.</p>

Paragraph 12 - Statistics

Programming	Operation
	<p>The main menu displays the pump operation times. By pressing the key you can access other statistics:</p> <ul style="list-style-type: none"> - Strokes = number of strokes made by the pump - Q.ty (L) = quantity dosed by the pump in litres; this figure is calculated on the basis of the memorised cc/stroke value - Power = number of pump starts - Reset = use the to reset the counters (YES) or otherwise (NO), then confirm by pressing the key. <p>Pressing the key will take you back to the main menu.</p>

Paragraph 13 – Password

Programming	Operation
	<p>By entering the password, you can enter the programming menu and see all the set values. The password will be requested whenever you seek to modify them. The flashing line indicates the number that can be modified.</p> <p>Use the key to select the number (from 1 to 9), and the key to select the number to be modified. Confirm by pressing the key. By setting “0000” (default), the password is eliminated.</p>

Paragraph 14 – Flow Alarm

Programming	Operation
	<p>This makes it possible to activate (deactivate) the flow sensor.</p> <p>When activated (On), press the key to access the request for the number of signals that the pump waits for before an alarm is triggered. The number flashes when you press the key, and you can then use the keys to set the value. Confirm by pressing the key. Press to return to the main menu.</p> <p>Batch mode can only be enabled in Recovery mode. The pump repeats the number of strokes that were not detected by the flow sensor. Press the button to request the maximum number of signals that the pump can recover before going into an alarm state. Pressing will cause the number to flash. At this point the user can use the and buttons to set the desired value. Press the button to confirm. Press to return to the main menu.</p>

Paragraph 15 – Level Alarm

Programming	Operation
	<p>This makes it possible to set the pump when the level sensor alarm is activated. In other words you can decide whether to stop dosage (Stop) or simply activate the alarm signal without stopping dosage.</p> <p>Changes can be made by pressing the key, then using the keys to set the alarm type. Confirm by pressing the key. Press to return to the main menu</p>

Paragraph 16 – Flow Display Unit

Programming	Operation
	<p>This makes it possible to set the dosage unit of measurement on the display.</p> <p>Changes can be made by pressing the key, then using the keys to set the unit of measurement, choosing between L/h (liters/hour), Gph (Gallons/hour), ml/m (milliliters/minute) or standard (% or frequency, depending on settings). Press to confirm and return to the main menu</p>

Paragraph 17 - Setting the Pause

Programming	Operation
	<p>The pump can be paused by remote input. The factory setting is Normally Open.</p> <p>Changes can be made by pressing the key, then using the keys to set the new value (N. OPEN or N. CLOSED).</p> <p>Press to confirm and return to the main menu.</p>

Display contrast adjustment.











For adjusting the display contrast keep the key pressed and within 5 seconds press the keys or to increase or decrease the contrast.

Alarms

Display	Cause	Interruption				
Fixed alarm LED Flashing word "Lev" I.e. <table border="1" data-bbox="172 1384 496 1451"> <tr><td>Man</td><td></td></tr> <tr><td>Lev</td><td>P100%</td></tr> </table>	Man		Lev	P100%	End of level alarm, without interrupting pump operation	Restore the liquid level.
Man						
Lev	P100%					
Fixed alarm LED Flashing words "Lev" and "stop" I.e. <table border="1" data-bbox="172 1525 496 1592"> <tr><td>Man</td><td></td></tr> <tr><td>Lev</td><td>Stop P100%</td></tr> </table>	Man		Lev	Stop P100%	End of level alarm, with interruption to pump operation	Restore the liquid level.
Man						
Lev	Stop P100%					
Flashing word "Mem" I.e. <table border="1" data-bbox="172 1637 496 1704"> <tr><td>1:n</td><td>6</td></tr> <tr><td>Mem</td><td></td></tr> </table>	1:n	6	Mem		The pump receives one or more pulses during dosage with memory function on Off	Press the key
1:n	6					
Mem						
Flashing word "Mem" I.e. <table border="1" data-bbox="172 1747 496 1814"> <tr><td>1:n</td><td><u>M</u> 6</td></tr> <tr><td>Mem</td><td></td></tr> </table>	1:n	<u>M</u> 6	Mem		The pump receives one or more pulses during dosage with memory function on On	When the pump finishes receiving external impulses, it returns the memorized strokes
1:n	<u>M</u> 6					
Mem						
Fixed alarm LED Flashing word "Flw" I.e. <table border="1" data-bbox="172 1883 496 1951"> <tr><td>Man</td><td><u>F</u></td></tr> <tr><td>Flw</td><td>P100%</td></tr> </table>	Man	<u>F</u>	Flw	P100%	Active flow alarm. The pump has not received the programmed number of signals from the flow sensor.	Press the key
Man	<u>F</u>					
Flw	P100%					
I.e. <table border="1" data-bbox="172 1995 496 2063"> <tr><td>Parameter Error</td><td></td></tr> <tr><td>PROG to default</td><td></td></tr> </table>	Parameter Error		PROG to default		Internal CPU communication error.	Press the key to restore the default parameters.
Parameter Error						
PROG to default						





Steuertafel – DOSATec LMS

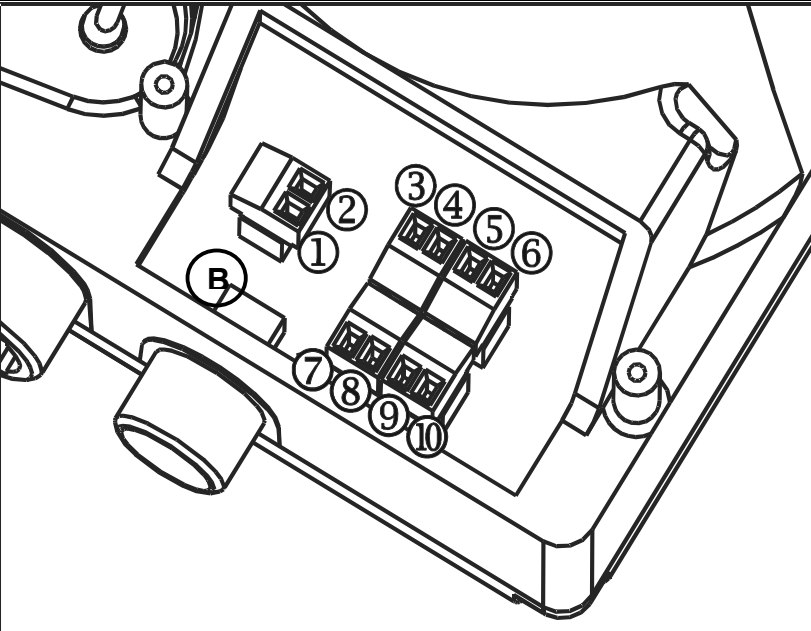

	Zugriff auf das Programmiermenü
	Während des Pumpenbetriebs: Durch Drücken werden die programmierten Werte zyklisch auf dem Display angezeigt; bei gleichzeitigem Drücken der Tasten   wird ein Wert, je nach ausgewähltem Betriebsmodus, erhöht bzw. verringert. Während der Programmierung übernimmt diese Taste die Funktion "Enter", d.h. dass der Zugriff auf die verschiedenen Menüstufen und die dort vorgenommenen Veränderungen bestätigt werden.
	Startet und stoppt die Pumpe. Wenn ein Füllstandsalarm (nur Alarmfunktion), ein Durchflussalarm und ein Memoryalarm aktiv ist, deaktiviert diese Taste die Anzeige auf dem Display.
	Zum "Verlassen" der verschiedenen Menüstufen. Vor dem endgültigen Verlassen der Programmierung öffnet sich ein Speicherdialog für Veränderungen.
	Blättert nach oben im Menü, oder erhöht die numerischen Werte, die verändert werden sollen. Im Batch-Modus kann diese Taste die Dosierung starten.
	Blättert nach unten im Menü, oder verringert die numerischen Werte, die verändert werden sollen.
	Grüne Led, die während dem Dosiervorgang blinkt.
	Rote Led, die sich bei den verschiedenen Alarmsituationen einschaltet.

Anschlüsse Elektrik

	1	Relaisausgang (Alarm) Wahlweise Öffner (NC) oder Schliesser (NO)	
	2		
	3	Pole +	4-20 mA Eingangs-Signal Eingang Widerstand: 200 ohm
	4	Pole -	
	5	-Eingang Fernbedienung(Start-Stop)	
	6	-Eingang Pause-signal	
	7	-Impuls – Eingang (Impuls – Wasserzähler)	
	8	-Eingang externes Trigger-signal	
	9	Eingang Fluss - Sensor	
	10		
B	Eingang Füllstandkontrolle		

Durch über drei Sekunden langes Drücken der Taste  erhalten Sie Zugriff auf die Programmierung. Über die Tasten   können Sie die Menüpunkte durchblättern. Über die Taste  erhalten Sie Zugriff auf die Veränderungen.

Werkseitig ist die Pumpe auf den Konstant-Modus programmiert. Die Pumpe kehrt nach 1 Minute Inaktivität automatisch zum Betriebs-Modus zurück. In diesem Fall werden etwaig eingegebene Daten nicht gespeichert.

Über die Taste  verlassen Sie die Programmierstufen. Bei Verlassen der Programmierung wird auf dem Display folgendes angezeigt:

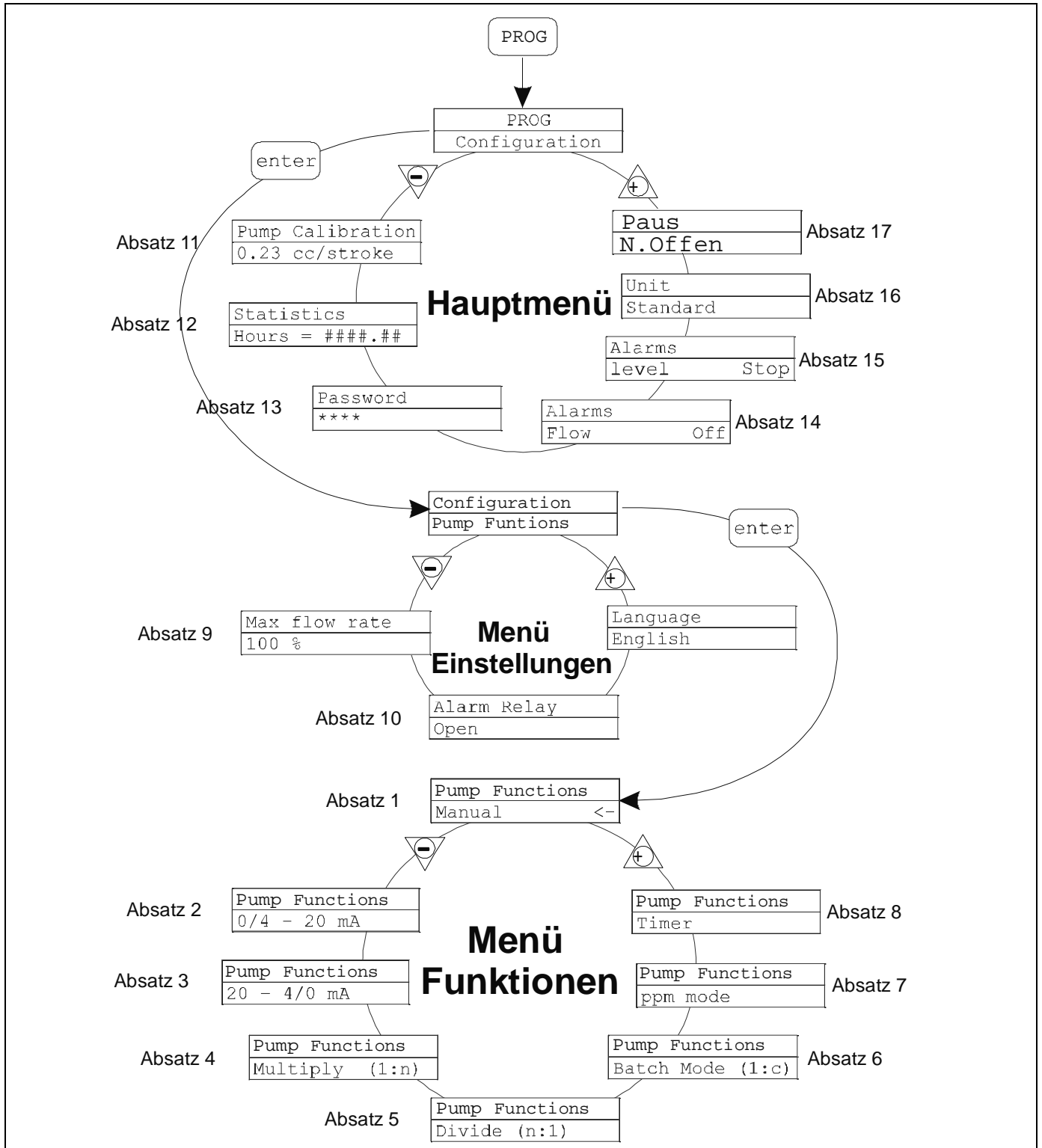
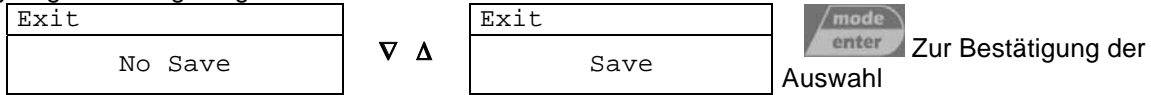

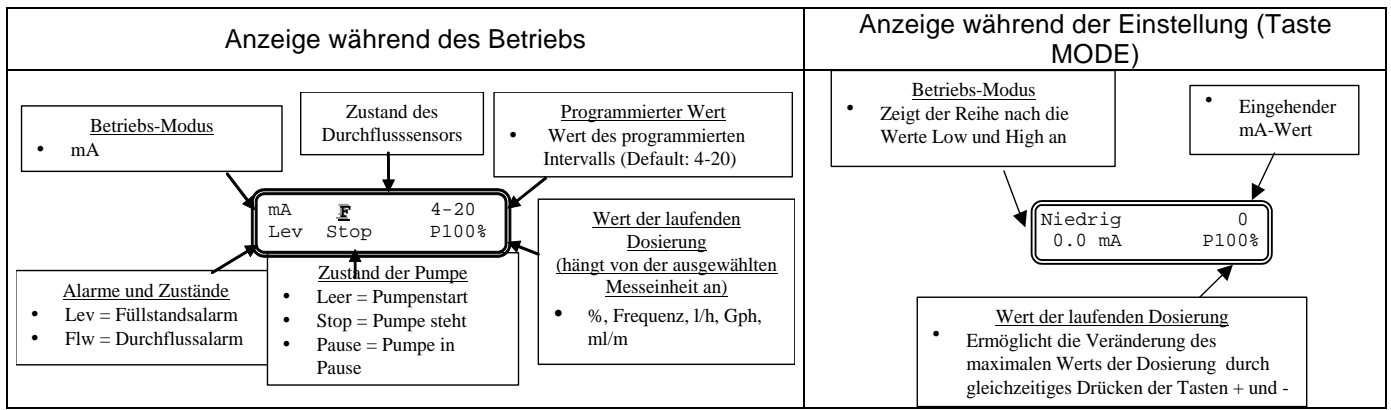

Absatz 3 – Proportionale Dosierung 20-4/0 mA

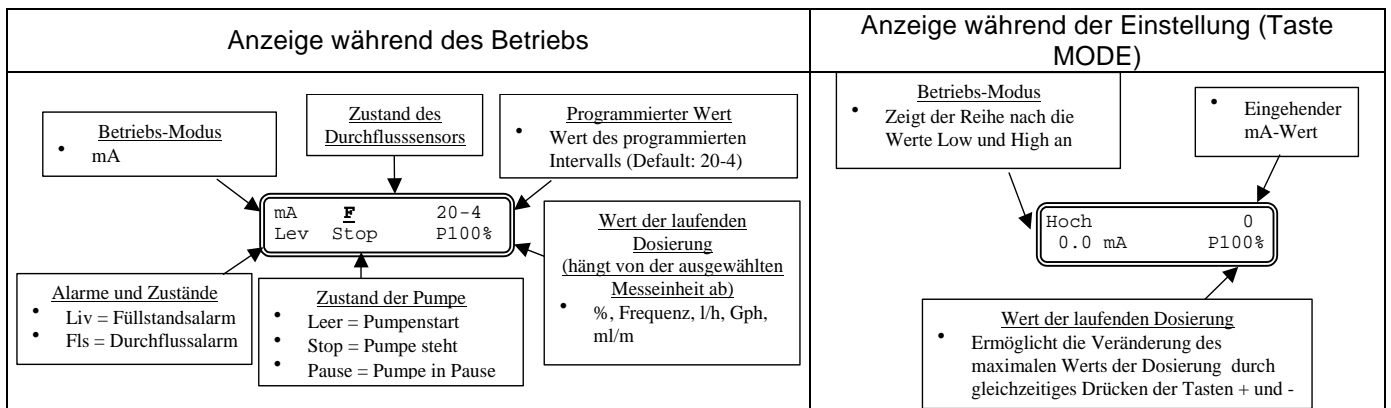
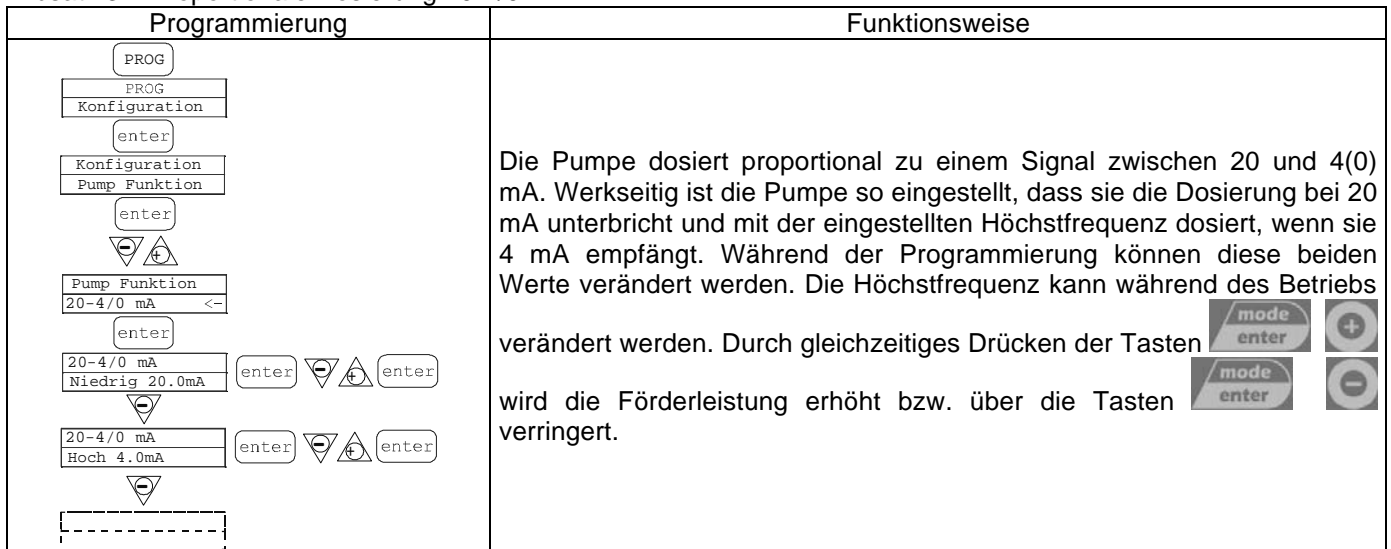

Absatz 4 – Proportionale Dosierung mit externen Impulsen (Multiplikation)

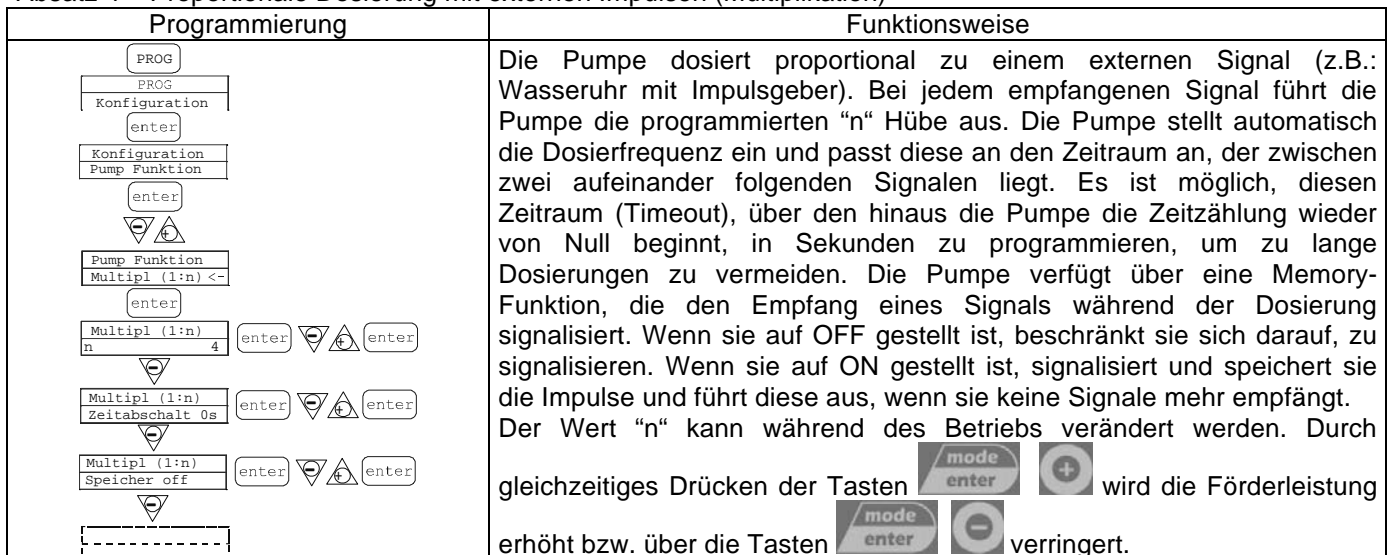

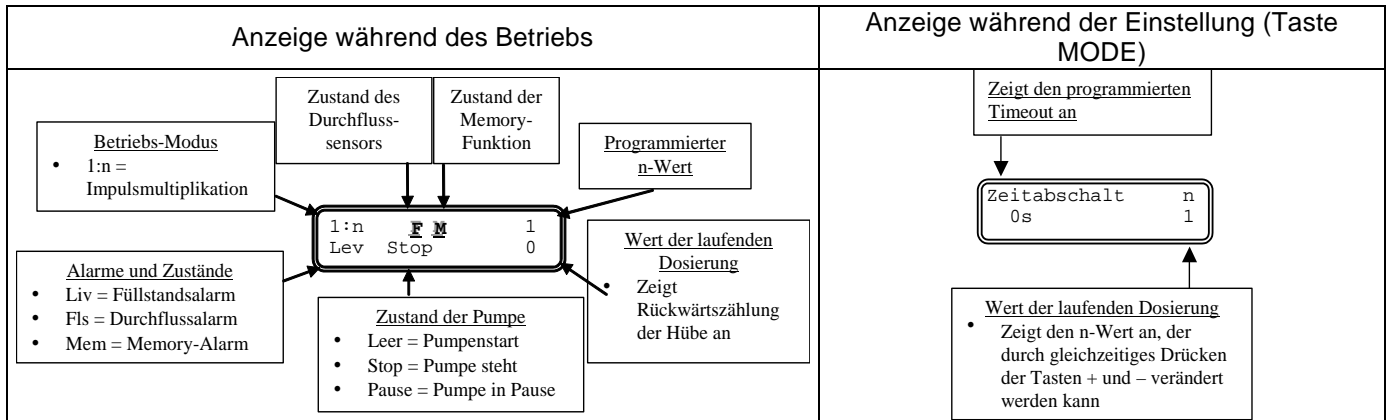

Absatz 5 – Proportionale Dosierung mit externen Impulsen (Division)

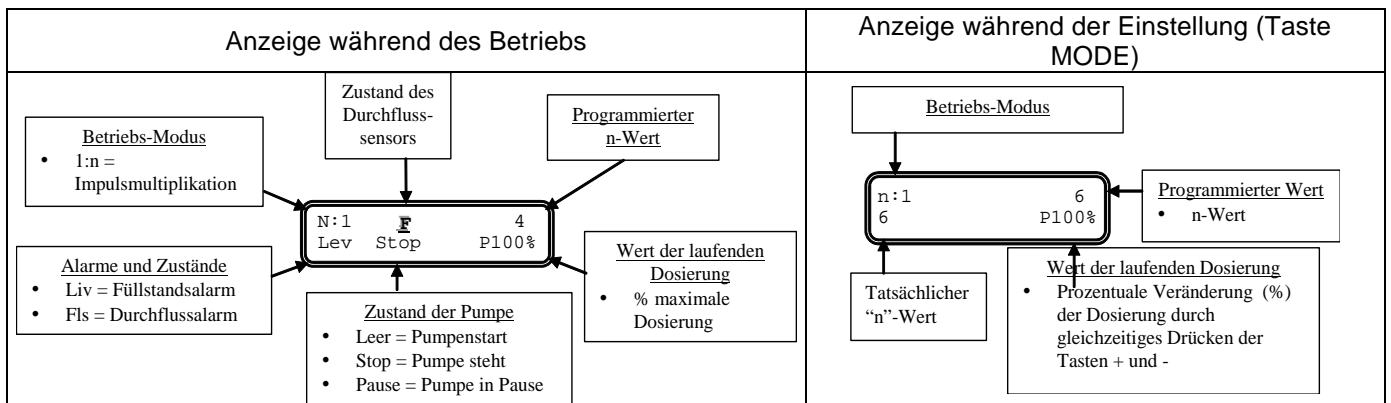
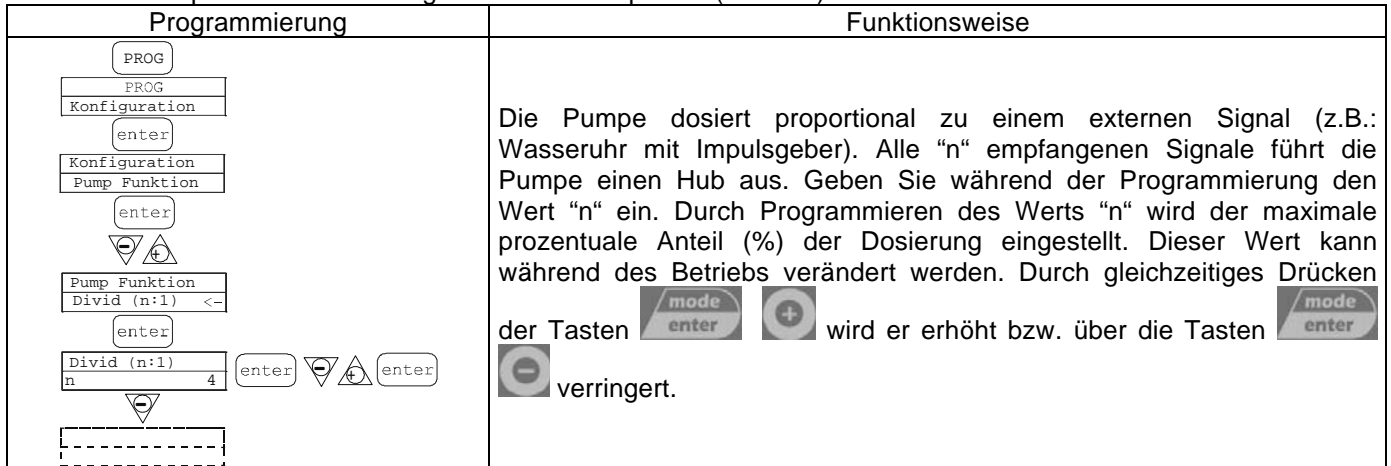

Absatz 6 – Proportionale Dosierung mit externen Impulsen (Batch-Dosierung)

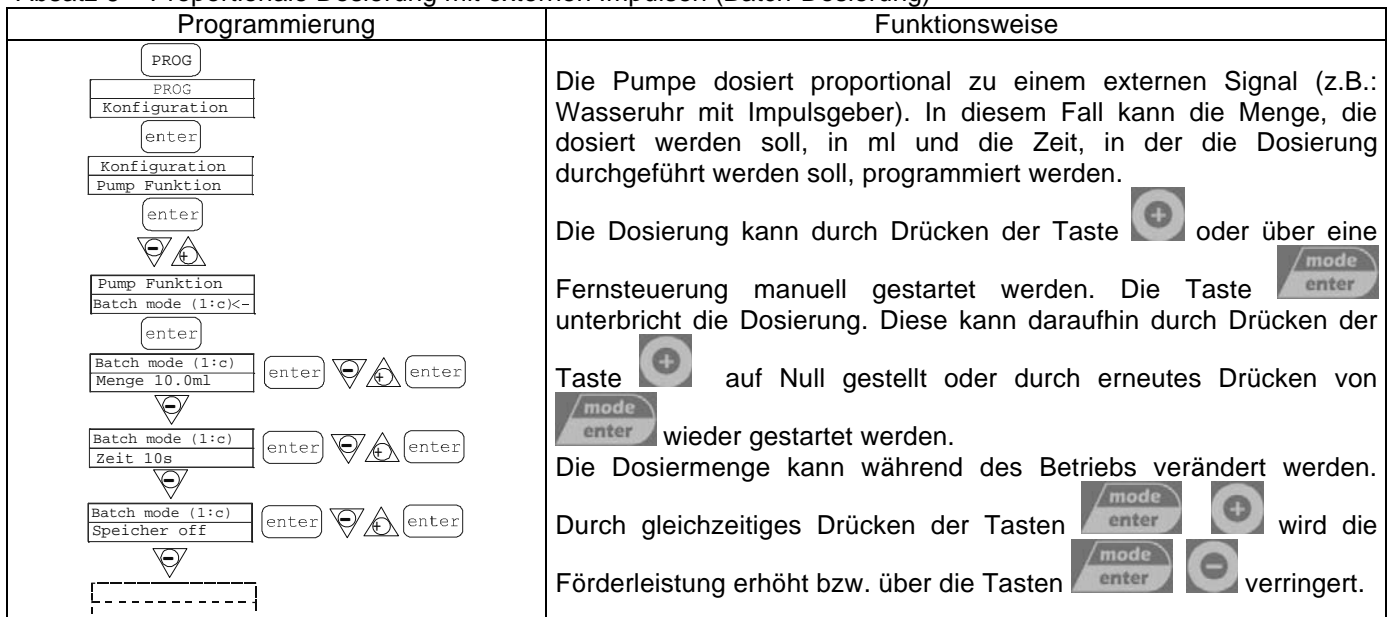

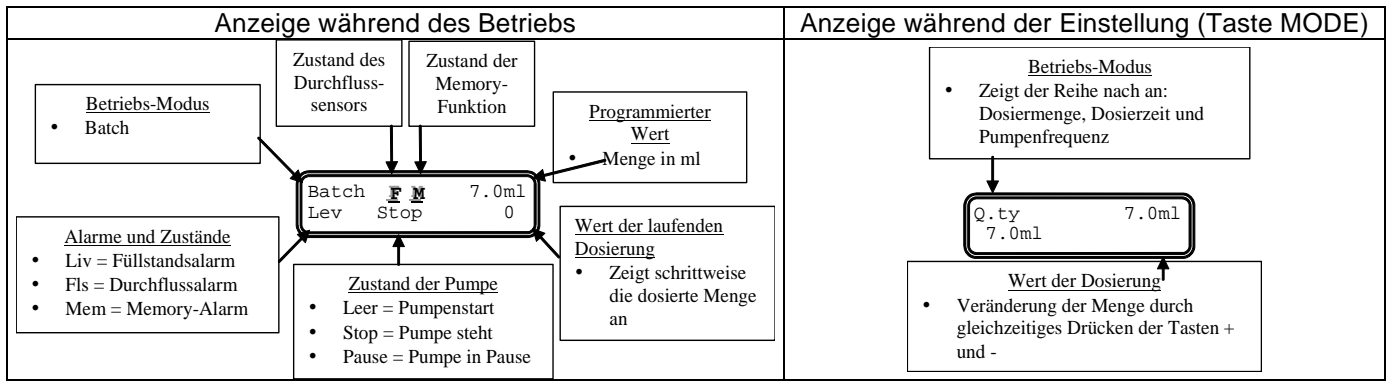

Absatz 7 – Proportionale Dosierung mit externen Impulsen (PPM-Dosierung)

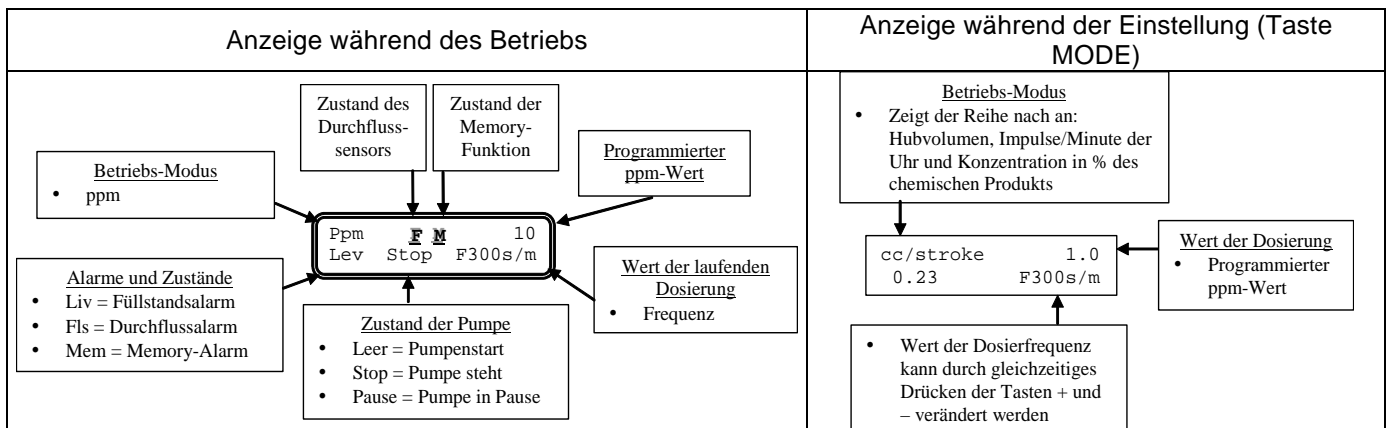
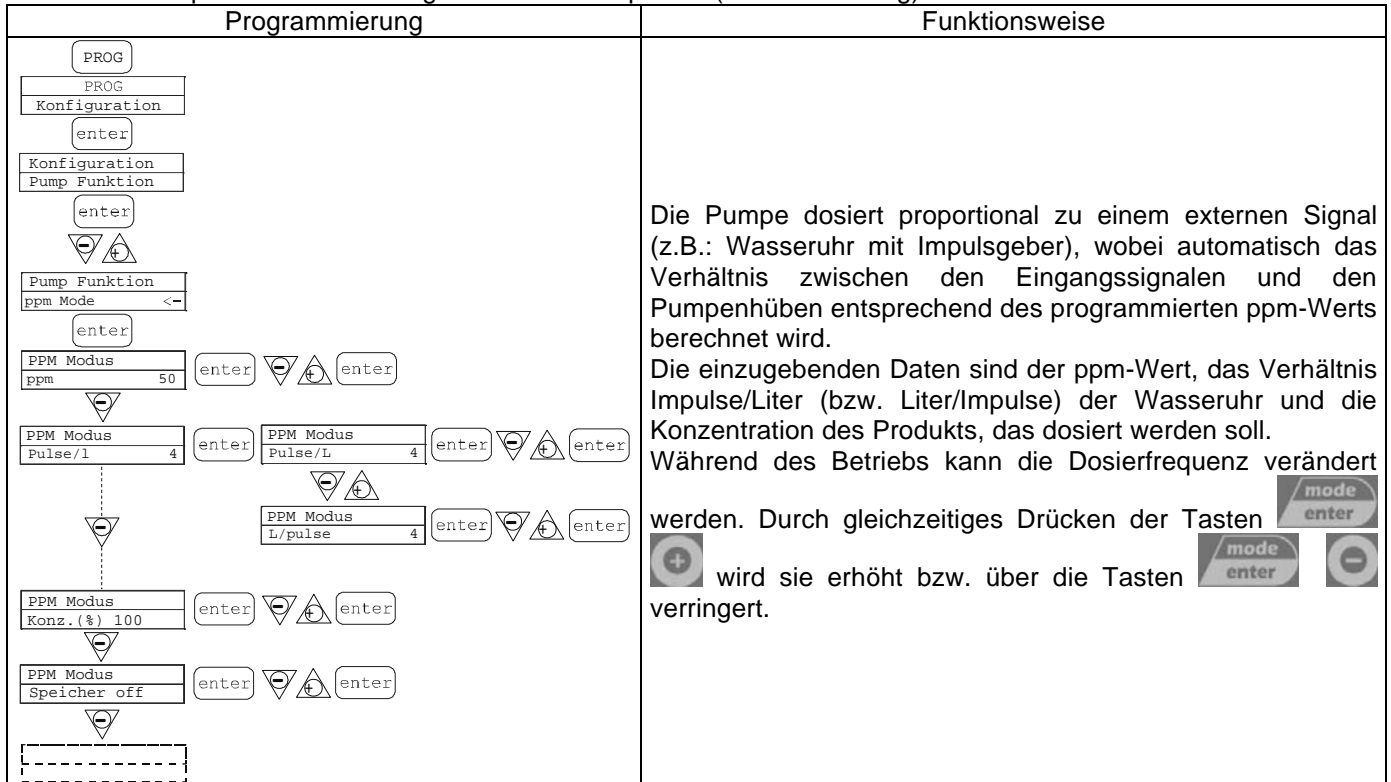

Absatz 8 – Getaktete Dosierung (Eingang Frequenzsignal "TRIGGER" aktiviert)

Programmazione	Funzionamento
<p>The screenshot shows the following menu structure:</p> <ul style="list-style-type: none"> PROG PROG Konfiguration Konfiguration Pumpen funktionen Pumpen funktionen Zeit Zeit Menge 100ml Zeit g.hh.mm Verzog. 0.01.50 Zeit g.hh.mm Interval 0.01.50 Trigger Modus N. Offen Pause Eingabem. Trigger Modus Trigger Modus N. Geschlossen Trigger Modus gesperrt 	<p>Nach Empfang des eingestellten TRIGGER-Signals dosiert die Pumpe eine in ml programmierbare Menge. Es kann eine Verzögerungszeit vor der Dosierung (Verzögerung) und der Zeitabstand zwischen aufeinander folgenden Dosierungen (Pause) eingestellt werden, wie im Schema gezeigt:</p> <p>Wird zum Beispiel eine Zeit Pause = 0 eingegeben, erhält man ein System, bei dem die programmierte Menge nach jedem TRIGGER-Signal dosiert wird (mit der etwaig eingestellten Verzögerung):</p> <p>Es ist auch möglich, die Dosierung durch Drücken der Taste + zu starten, die praktisch das Trigger-Signal nachahmt. Das Trigger-Signal kann auf N.Offen eingestellt werden (es aktiviert sich, wenn der Eingang von der Betriebsart geöffnet zur Betriebsart geschlossen übergeht), oder auf N. Geschlossen (es aktiviert sich, wenn der Eingang von der Betriebsart geschlossen zur Betriebsart geöffnet übergeht).</p> <p>Das Trigger-Signal ist während der Dosierung blockiert (sein Empfang wird weder gespeichert, noch verwaltet). Der Eingang Pause (Eingang Fernbedienung) kann nicht programmiert werden und seine Aktivierung blockiert die Dosierung, während die nachfolgende Deaktivierung das System wieder in den Zustand Warten auf das Trigger-Signal für eine neue Dosierung versetzt.</p> <p>Während des Pumpenbetriebs kann die Dosierfrequenz verändert werden, indem gleichzeitig die Tasten gedrückt werden, um die Frequenz zu erhöhen bzw. die Tasten um sie zu verringern.</p>
<p>Anzeige während des Betriebs</p> <p>The display shows:</p> <ul style="list-style-type: none"> Betriebsart: Timer Status Durchflusssensor Programmierter Wert: Menge in ml Timer: F Stop 7,0 ml P 0% Wert der laufenden Dosierung: Prozentualer Anteil der Hübe/min. max. Alarmer und Zustände: Füllst. = Füllstandsalarm, Durchfluss = Durchflussalarm oder Wartezeit Abgabe Pumpenstatus: Leer = Pumpe gestartet, Stop = Pumpe gestoppt, Reinitialisierung = Pumpe wird neugestartet 	<p>Anzeige während der Einstellung (Taste MODE)</p> <p>The display shows:</p> <ul style="list-style-type: none"> Betriebsart: Es werden der Reihenfolge nach angezeigt: Zu dosierende Menge, Verzögerung in T/S/M und Pause in T/S/M Menge: 20,0 ml P 100 Wert der Dosierung: Programmierter Menge in ml Wert des prozentualen Anteils der Dosierung, durch Drücken der Tasten + oder - veränderbar

Absatz 8 – Getaktete Dosierung (Eingang Frequenzsignal "TRIGGER" nicht aktiviert)

Programmation	Funktionsweise
	<p>Die Pumpe dosiert eine in ml programmierbare Menge. Es kann eine Startverzögerung der Pumpe (Verzögerung) und der Zeitabstand zwischen zwei aufeinander folgenden Dosierungen (Pause) eingestellt werden, wie im Schema gezeigt:</p> <p>Die Verzögerungs- und Pausenzeiten sind in T/S/M (Tage, Stunden, Minuten) angegeben.</p> <p>Der Pausen-Eingang kann auf drei unterschiedliche Arten programmiert werden:</p> <ol style="list-style-type: none"> 1. Blocki Zeit: Bei aktivierter Pause blockiert das System die Zählung der aktuellen Zeit und nimmt sie wieder auf, wenn die Pause deaktiviert wird. 2. Dosierpause: Bei aktivierter Pause zählt das System die Zeit weiter und blockiert die Dosierung. 3. Time neu start.: Bei aktivierter Pause blockiert das System die Dosierung und startet die Zählung neu, wenn die Pause deaktiviert wird. <p>Während des Pumpenbetriebs kann die Dosierfrequenz verändert werden, indem gleichzeitig die Tasten gedrückt werden, um die Frequenz zu erhöhen bzw. die Tasten , um sie zu verringern.</p>

Anzeige während des Betriebs	Anzeige während der Einstellung (Taste MODE)

Absatz 9 – Einstellung der maximalen Förderleistung

Programmierung	Funktionsweise
	<p>Ermöglicht die Einstellung der maximalen Förderleistung, die die Pumpe erreichen kann, und der programmierte Betriebs-Modus (% oder Frequenz) wird zur Anzeige der Förderleistung in der Standardmesseinheit. Durch Drücken von erhalten Sie Zugriff auf die Veränderung. Stellen Sie dann über die Tasten den Wert ein. Über bestätigen Sie und werden zum Hauptmenü zurückgeleitet.</p>

Absatz 10 – Einstellung Alarmrelais

Programmierung	Funktionsweise
<pre> graph TD A[PROG] --> B[PROG Configuration] B --> C[Configuration Pump Functions] C --> D[Max flow rate P100%] D --> E[Alarm Relay N.Open] E -- enter --> F[] F -- +/- --> G[] G -- enter --> H[] H --> I[] </pre>	<p>Wenn keine Alarmsituation vorliegt, kann es auf geöffnet (werkseitige Einstellung) oder geschlossen gestellt werden.</p> <p>Durch Drücken von erhalten Sie Zugriff auf die Veränderung. Stellen Sie dann über die Tasten den Wert ein. Über bestätigen Sie und werden zum Hauptmenü zurückgeleitet.</p>

Absatz 11 – Kalibrierung der Förderleistung

Programmierung	Funktionsweise
<pre> graph TD A[PROG] --> B[PROG Konfiguration] B --> C[] C --> D[Pumpe Kalibr 0,23 ml/Hub] D -- enter --> E[Pumpe Kalibr Manuell] E -- enter --> F[Pumpe Kalibr ML/Hub 0,23] F -- +/- --> G[] G -- enter --> H[Pumpe Kalibr Automatik] H -- enter --> I[Automatik Kal Start 100 Hube] I -- enter --> J[Automatik Kal Strokes 100] J -- +/- --> K[] K -- enter --> L[Automatik Kal ml 20] L -- +/- --> M[] M -- enter --> N[] </pre>	<p>Im Hauptmenü erscheint das gespeicherte Hubvolumen. Es kann auf zwei Arten kalibriert werden:</p> <p>MANUELL – Geben Sie über die Tasten manuell das Hubvolumen ein und bestätigen Sie über .</p> <p>AUTOMATISCH – Die Pumpe führt 100 Hübe aus, die über die Taste gestartet und über bestätigt werden. Wenn diese Hübe ausgeführt worden sind, geben Sie über die Tasten die von der Pumpe angesaugte Menge ein und bestätigen Sie über .</p> <p>Der eingegebene Wert wird bei der Berechnung der Förderleistungen verwendet.</p>

Absatz 12 – Statistiken

Programmierung	Funktionsweise
<pre> graph TD A[PROG] --> B[PROG Konfiguration] B --> C[] C --> D[Statistik Stunden 10] D -- enter --> E[Statistik Huebe 1000] E -- +/- --> F[Statistik Menge(L) 100] F -- +/- --> G[Statistik Netzstrom 10] G -- +/- --> H[Statistik Rucksetzen] H -- enter --> I[Stat. Rucksetzen NO] I -- +/- --> J[] J -- enter --> K[ESC] K --> L[Statistik Stunden 10] L -- +/- --> M[] </pre>	<p>Im Hauptmenü werden die Betriebsstunden der Pumpe angezeigt. Durch Drücken der Taste erhalten Sie Zugriff auf die anderen Statistiken:</p> <ul style="list-style-type: none"> - Strokes = Anzahl der von der Pumpe ausgeführten Hübe - Q.ty(L) = in Litern ausgedrückte von der Pumpe dosierte Menge; dieser Wert wird entsprechend des gespeicherten Hubvolumens berechnet. - Power = Anzahl der Pumpenstarts - Reset = über die Tasten können Sie wählen, ob Sie die Uhr auf Null stellen möchten (YES) oder nicht (NO), über bestätigen Sie. <p>Durch Drücken von gelangen Sie zum Hauptmenü zurück.</p>

Absatz 13 – Passwort

Programmierung	Funktionsweise
	<p>Durch Eingabe des Passworts erhalten Sie Zugriff auf die Programmierung und können sich alle eingegebenen Werte ansehen. Jedes Mal wenn Sie versuchen, diese Werte zu verändern, erscheint ein eigener Passwortdialog. Die blinkende Linie zeigt die veränderbare Nummer an.</p> <p>Wählen Sie über die Taste die Nummer aus (zwischen 1 und 9), wählen Sie über die Taste die Nummer aus, die verändert werden soll, und bestätigen Sie anschließend über . Durch Eingabe von "0000" (werkseitige Einstellung) wird die Passwortabfrage übersprungen.</p>

Absatz 14 – Durchflussalarm

Programmierung	Funktionsweise
	<p>Ermöglicht die Aktivierung (Deaktivierung) des Durchflusssensors.</p> <p>Wenn er einmal aktiviert ist (ON), erhalten Sie durch Drücken der Taste Zugriff auf den Abfragedialog, wie viele Signale die Pumpe abwartet, bevor Sie einen Alarm auslöst. Durch Drücken von beginnt die Nummer zu blinken. Stellen Sie dann über die Tasten den Wert ein. Über bestätigen Sie. Durch Drücken von werden Sie zum Hauptmenü zurückgeleitet.</p> <p>Nur im Batch-Modus kann der Modus „Nachholen“ aktiviert werden. Die Pumpe wiederholt die Anzahl der Hübe, die nicht vom Durchflusssensor erfasst wurden.</p> <p>Durch Drücken der Taste erhalten Sie Zugriff auf die Anfrage der maximalen Anzahl an Signalen, die die Pumpe nachholen kann, bevor der Alarm ausgelöst wird.</p> <p>Durch Drücken von blinkt die Zahl, dann die Tasten drücken, um den Wert einzustellen. Mit bestätigen. Durch Drücken von kehren Sie zum Hauptmenü zurück</p>

Absatz 15 – Füllstandsalarm

Programmierung	Funktionsweise
	<p>Ermöglicht die Einstellung des Zeitpunkts, an dem der Füllstandsalarm aktiviert wird, also auch ob die Dosierung blockiert (Stop), oder einfach nur das Alarmsignal aktiviert werden soll, ohne dabei die Dosierung zu blockieren.</p> <p>Durch Drücken von erhalten Sie Zugriff auf die Veränderung. Stellen Sie dann über die Tasten die Alarmart ein. Über bestätigen Sie. Durch Drücken von werden Sie zum Hauptmenü zurückgeleitet.</p>

Absatz 16 – Anzeigeeinheit der Förderleistung

Programmierung	Funktionsweise
	<p>Ermöglicht die Einstellung der Maßeinheit der Dosierung über eine Anzeige auf dem Display.</p> <p>Durch Drücken von erhalten Sie Zugriff auf die Veränderung. Stellen Sie dann über die Tasten die gewünschte Maßeinheit ein, L/H (Liter/Stunde), GpH (Gallone/Stunde), ml/m (Milliliter/Minute) oder die Standardeinstellung (% oder Frequenz, je nach Einstellung). Über bestätigen Sie und werden zum Hauptmenü zurückgeleitet.</p>

Absatz 16 - Einstellung Pause

Programmierung	Funktionsweise
	<p>Steuereingang: Pumpe Stop / Start. Werkseinstellung: Bei Schließerkontakt (elektrisch leitende Verbindung zwischen beiden Anschlussklemmen) Pumpenstop.</p> <p>Durch Drücken von erhalten Sie Zugriff auf die Veränderung.</p> <p>Stellen Sie dann über die Tasten den Wert ein (N. OFFEN oder N. GESCHLOSSEN).</p> <p>Über bestätigen Sie und werden zum Hauptmenü zurückgeleitet.</p>



Absatz 17 - Einstellung Pause

Programmierung	Funktionsweise
	<p>Steuereingang: Pumpe Stop / Start. Werkseinstellung: Bei Schließerkontakt (elektrisch leitende Verbindung zwischen beiden Anschlussklemmen) Pumpenstop.</p> <p>Durch Drücken von erhalten Sie Zugriff auf die Veränderung.</p> <p>Stellen Sie dann über die Tasten den Wert ein (N. OFFEN oder N. GESCHLOSSEN).</p> <p>Über bestätigen Sie und werden zum Hauptmenü zurückgeleitet.</p>

Display - Einstellung Kontrast

Für die Einstellung des Display-Kontrasts wird die Taste festgedrückt und innerhalb von 5 Sekunden mit den Tasten oder der gewünschte Kontrast festgelegt

Alarme

Anzeige	Ursache	Unterbrechung						
Alarm-Led leuchtet kontinuierlich Der Schriftzug Lev blinkt Bsp. <table border="1" style="display: inline-table; vertical-align: middle;"> <tr> <td>Man</td> <td></td> <td></td> </tr> <tr> <td>Lev</td> <td>P100%</td> <td></td> </tr> </table>	Man			Lev	P100%		Alarm Füllstand nicht ausreichend, ohne Unterbrechung des Pumpenbetriebs	Flüssigkeit nachfüllen
Man								
Lev	P100%							
Alarm-Led leuchtet kontinuierlich Der Schriftzug Lev und Stop blinkt Bsp. <table border="1" style="display: inline-table; vertical-align: middle;"> <tr> <td>Man</td> <td></td> <td></td> </tr> <tr> <td>Lev</td> <td>Stop</td> <td>P100%</td> </tr> </table>	Man			Lev	Stop	P100%	Alarm Füllstand nicht ausreichend, mit Unterbrechung des Pumpenbetriebs	Flüssigkeit nachfüllen
Man								
Lev	Stop	P100%						
Der Schriftzug Mem blinkt Bsp. <table border="1" style="display: inline-table; vertical-align: middle;"> <tr> <td>l:n</td> <td></td> <td>6</td> </tr> <tr> <td>Mem</td> <td></td> <td></td> </tr> </table>	l:n		6	Mem			Die Pumpe empfängt einen oder mehrere Impulse während der Dosierung mit Memory-Funktion in Off-Stellung	Die Taste  drücken
l:n		6						
Mem								
Der Schriftzug Mem blinkt Bsp. <table border="1" style="display: inline-table; vertical-align: middle;"> <tr> <td>l:n</td> <td><u>M</u></td> <td>6</td> </tr> <tr> <td>Mem</td> <td></td> <td></td> </tr> </table>	l:n	<u>M</u>	6	Mem			Die Pumpe empfängt einen oder mehrere Impulse während der Dosierung mit Memory-Funktion in On-Stellung	Wenn die Pumpe keine externen Impulse mehr empfängt, führt sie die gespeicherten Hübe aus
l:n	<u>M</u>	6						
Mem								
Alarm-Led leuchtet kontinuierlich Der Schriftzug Flw blinkt Bsp. <table border="1" style="display: inline-table; vertical-align: middle;"> <tr> <td>Man</td> <td><u>F</u></td> <td></td> </tr> <tr> <td>Flw</td> <td></td> <td>P100%</td> </tr> </table>	Man	<u>F</u>		Flw		P100%	Durchflussalarm aktiv, die Pumpe hat nicht die programmierten Signale vom Durchflusssensor empfangen.	Die Taste  drücken
Man	<u>F</u>							
Flw		P100%						
Bsp. <table border="1" style="display: inline-table; vertical-align: middle;"> <tr> <td>Parameter Error</td> </tr> <tr> <td>PROG to default</td> </tr> </table>	Parameter Error	PROG to default	Interner Kommunikationsfehler der CPU.	Die Taste  drücken, um auf die Default-Parameter rückzustellen.				
Parameter Error								
PROG to default								





Panel de control – DOSA Tec LMS



	Acceso al menú de programación.
	Durante el funcionamiento de la bomba: Si se pulsa visualiza cíclicamente en el display los valores programados; si se pulsa simultáneamente a las teclas aumenta o disminuye un valor dependiente del modo de funcionamiento escogido. En programación ejerce la función “enter”, es decir, confirma la entrada de los diferentes niveles del menú y las modificaciones en el interior de los mismos.
	Pone en marcha y detiene la bomba. En condiciones de alarma de nivel (sólo función de alarma), de alarma de flujo y alarma <i>memory</i> activas, desactiva la señalización en el display.
	Para “salir” de los diferentes niveles del menú. Antes de salir definitivamente de la programación se accede a la solicitud de memorización de las modificaciones.
	Desplaza los menús hacia arriba o aumenta los valores numéricos a modificar. En modo Batch puede poner en marcha la dosificación.
	Desplaza los menús hacia abajo o disminuye los valores numéricos a modificar.
	Led verde parpadeante durante la dosificación.
	Led rojo que se enciende durante las diferentes situaciones de alarma.

Conexiones eléctricas

	1	Relé de Alarma	
	2		
	3	Pole +	Entrada señal 4-20 mA Impedancia De Entrada: 200 ohm
	4	Pole -	
	5	-Entrada control externo (start-stop)	
	6	-Entrada señal de pausa	
	7	-Entrada señal en frecuencia (contador emisor de impulsos)	
	8	-Entrada trigger externo	
	9	Entrada sensor de Flujo	
	10		
B	Entrada sonda de nivel		

Pulsando la tecla  durante más de tres segundos se accede a la programación. Con las teclas   se pueden desplazar las voces del menú, con la tecla  se accede a las modificaciones. En la fábrica la bomba se programa en modo constante. La bomba vuelve automáticamente al modo de funcionamiento después de 1 minuto de inactividad. En este caso los datos que se han introducido no serán memorizados. Con la tecla  se sale de los niveles de la programación. Al salir de la programación el display visualiza:

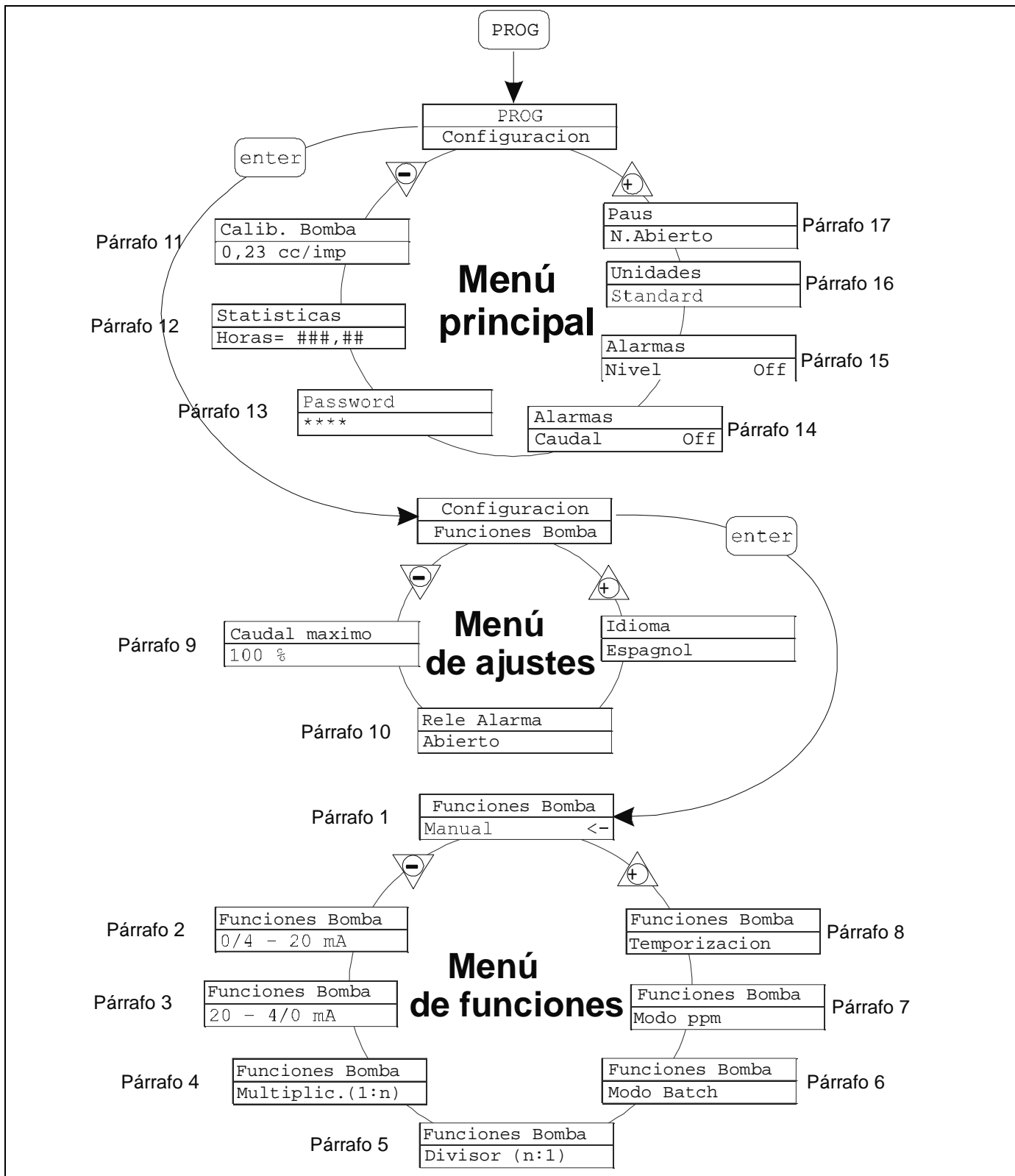
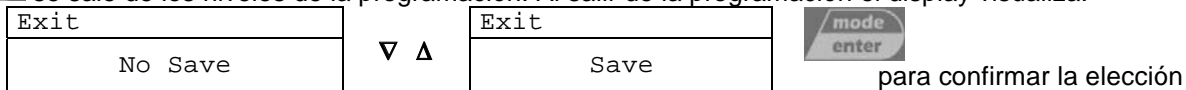

Programación del idioma

Programación	Funcionamiento
<pre> graph TD A[PROG] --> B[PROG Configuration] B -- enter --> C[Configuration Pump Functions] C --> D[Max flow rate P100%] D --> E[Alarm Relay N.Open] E --> F[Language English] F -- enter --> G[] G --> H[] H --> I[] I --> A </pre>	<p>Permite seleccionar el idioma, en la fábrica la bomba se programa en inglés. Pulsando la tecla se accede a la modificación, con las teclas se programa el valor. Con la tecla se confirma y se vuelve al menú principal.</p>

Párrafo 1 – Dosificación manual

Programación	Funcionamiento
<pre> graph TD A[PROG] --> B[PROG Configuracion] B -- enter --> C[Configuracion Funciones Bomba] C -- enter --> D[Funciones Bomba Manual] D -- enter --> E[] E --> F[] F --> A </pre>	<p>La bomba trabaja en modo constante. El caudal se regula manualmente pulsando simultáneamente las teclas para aumentarlo o las teclas para disminuirlo.</p>

Visualización durante el funcionamiento	Visualización en programación (tecla MODE)
<p>Modo de funcionamiento</p> <ul style="list-style-type: none"> Man = Manual <p>Alarmas y estados</p> <ul style="list-style-type: none"> Liv = Alarma de nivel Fls = Alarma de flujo <p>Estado del sensor de FLUJO</p> <p>Estado de la bomba</p> <ul style="list-style-type: none"> Vacío = bomba en start Stop = bomba parada Pausa = bomba en pausa <p>Valor de la dosificación en curso (depende de la unidad de medida seleccionada)</p> <ul style="list-style-type: none"> Porcentaje, Frecuencia, l/h, Gph, ml/m <p>Display: MAN Lev Stop P100%</p>	<p>Modo de funcionamiento</p> <ul style="list-style-type: none"> Visualiza el valor correspondiente de la frecuencia <p>Display: F320s/m P100%</p> <p>Valor de la dosificación en curso</p> <ul style="list-style-type: none"> Modifica el caudal máximo pulsando simultáneamente las teclas + o -

Párrafo 2 – Dosificación Proporcional con señal 0/4-20 mA

Programación	Funcionamiento
<pre> graph TD A[PROG] --> B[PROG Configuracion] B -- enter --> C[Configuracion Funciones Bomba] C -- enter --> D[Funciones Bomba 0/4 - 20 mA] D -- enter --> E[Bajo 4.0mA] E -- enter --> F[Alto 20.0mA] F -- enter --> G[] G --> H[] H --> A </pre>	<p>La bomba dosifica proporcionalmente al recibir una señal (0) 4-20 mA. Según su programación de fábrica, la bomba interrumpe la dosificación a 4 mA y dosifica a la máxima frecuencia programada cuando recibe 20 mA. En programación se pueden modificar estos dos valores. La frecuencia máxima se puede modificar durante el funcionamiento pulsando simultáneamente las teclas para aumentar el caudal o las teclas para disminuirlo.</p>

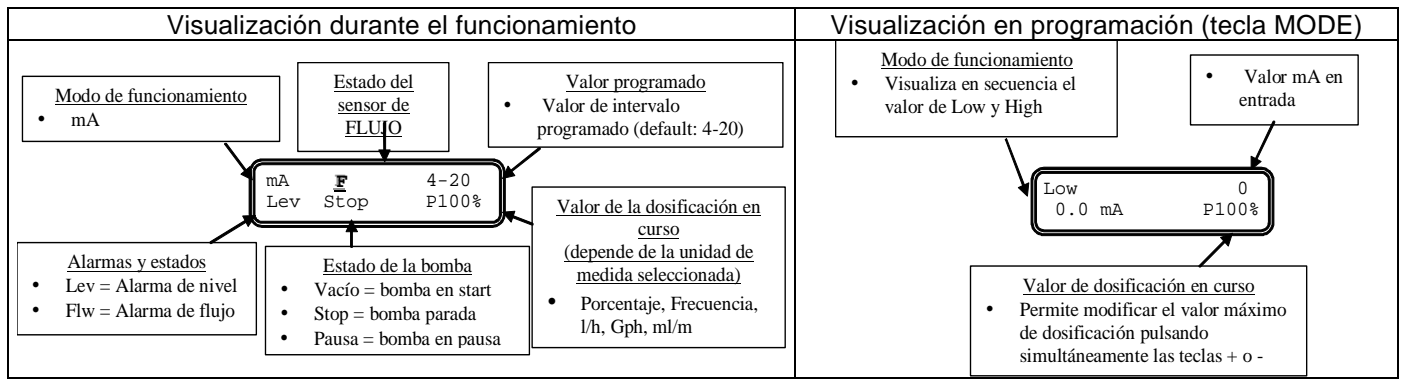

Párrafo 3 – Dosificación Proporcional con señal 20-4/0 mA

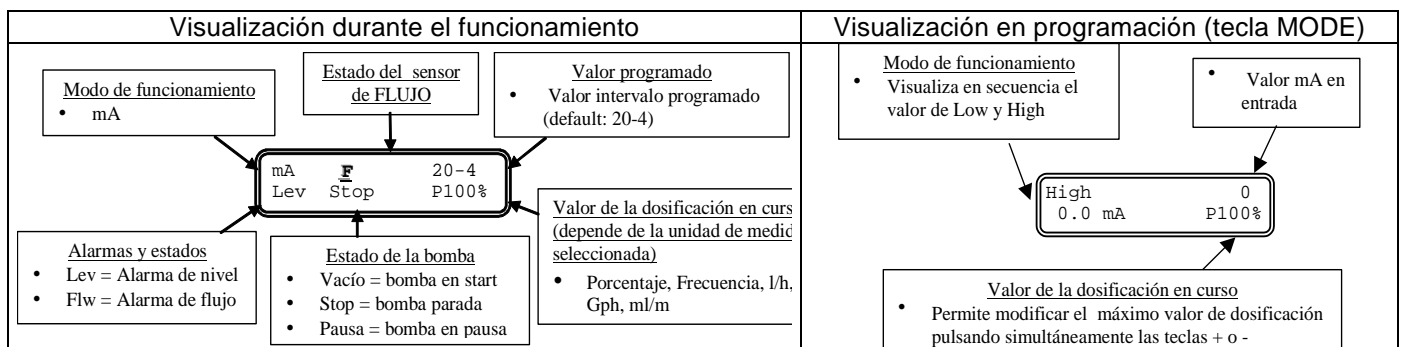
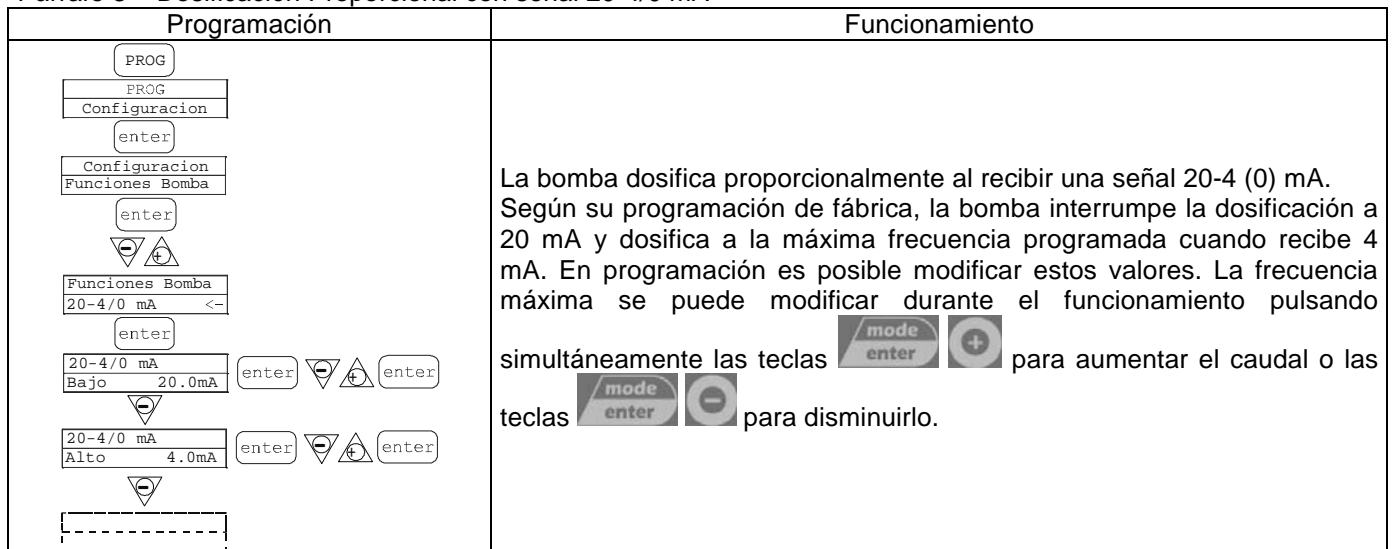

Párrafo 4 – Proporcional con impulsos externos (multiplicación)

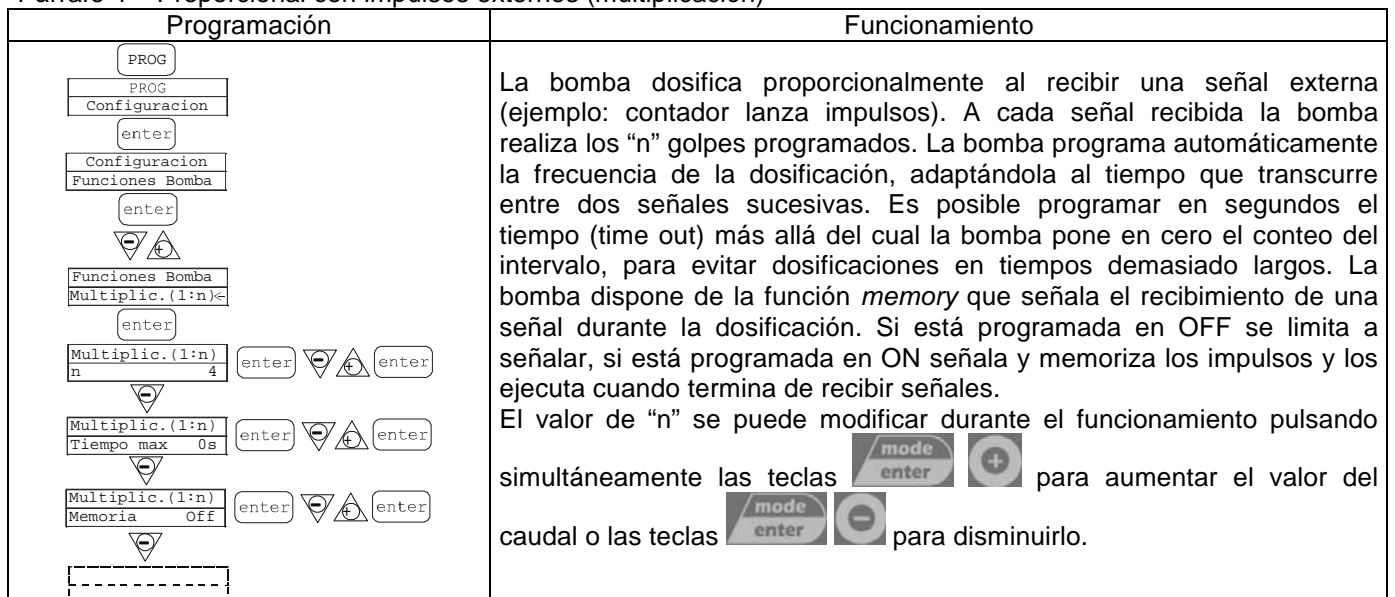

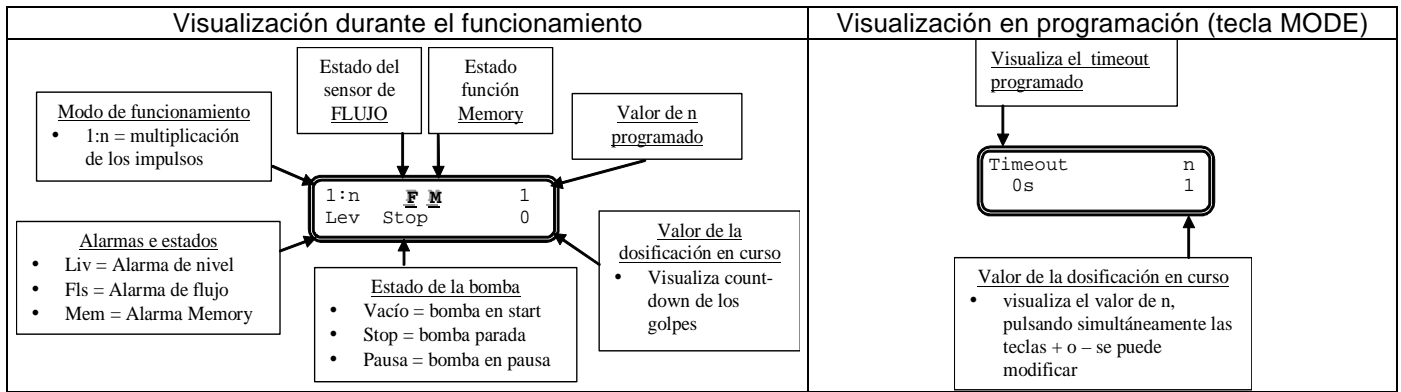

Párrafo 5 – Proporcional con impulsos externos (división)

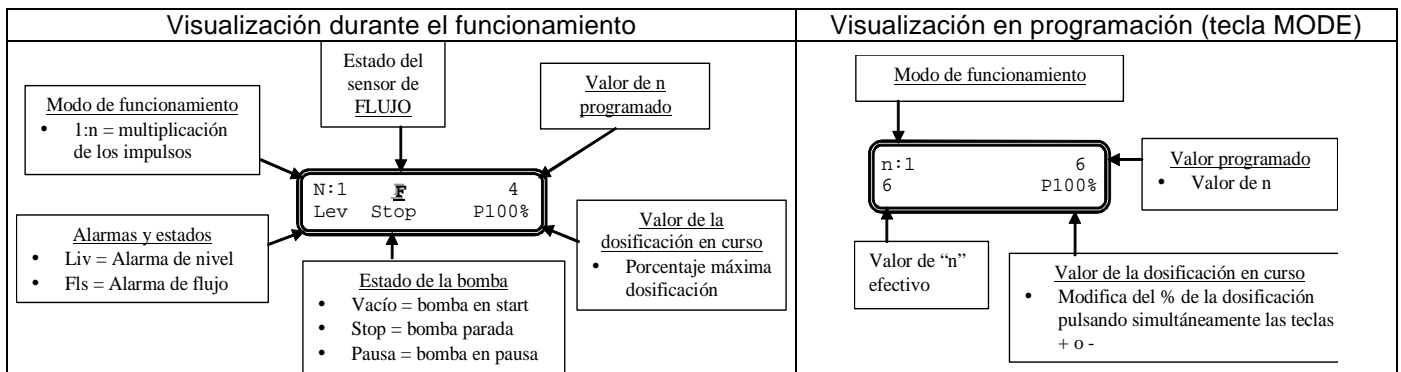
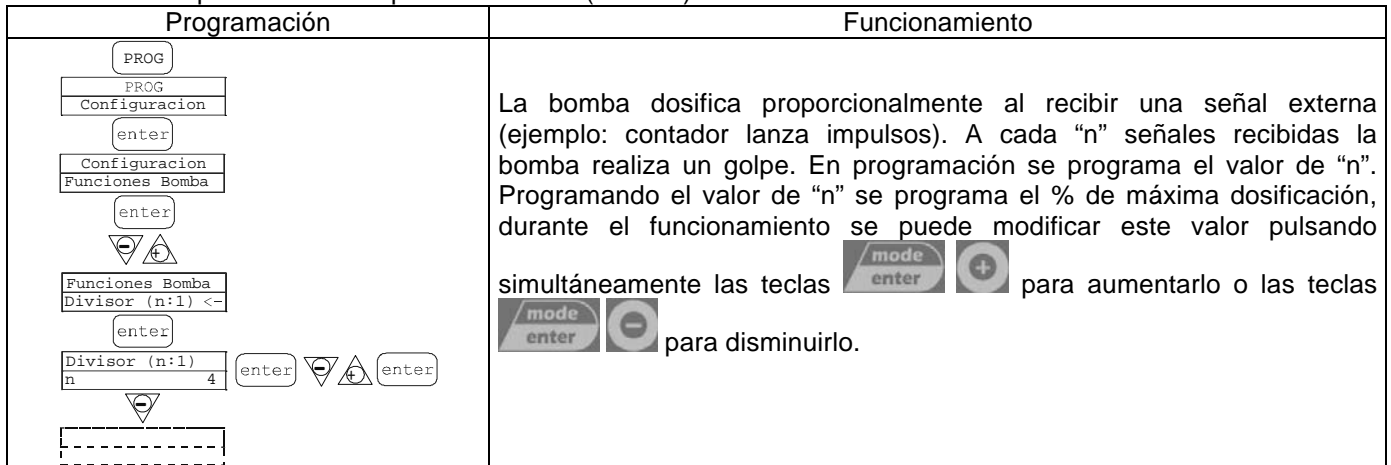

Párrafo 6 – Proporcional con impulsos externos (dosificación Batch)

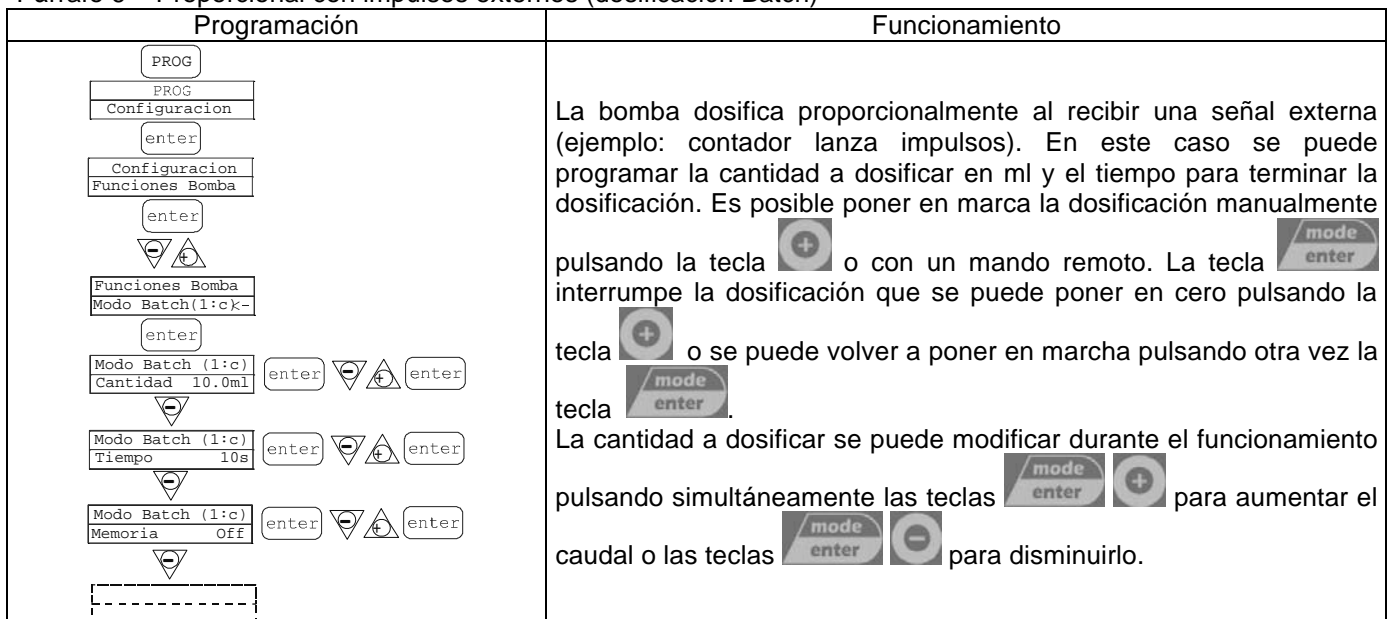

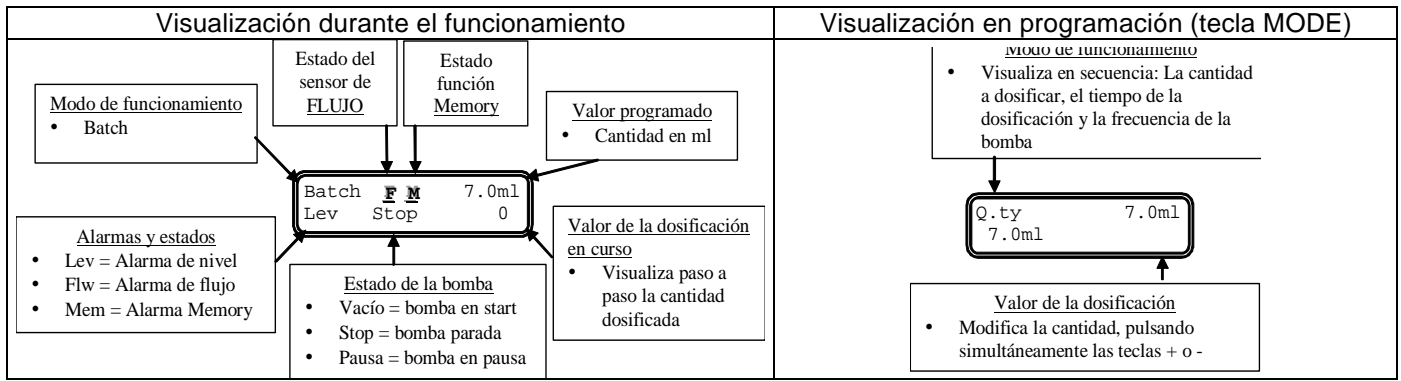

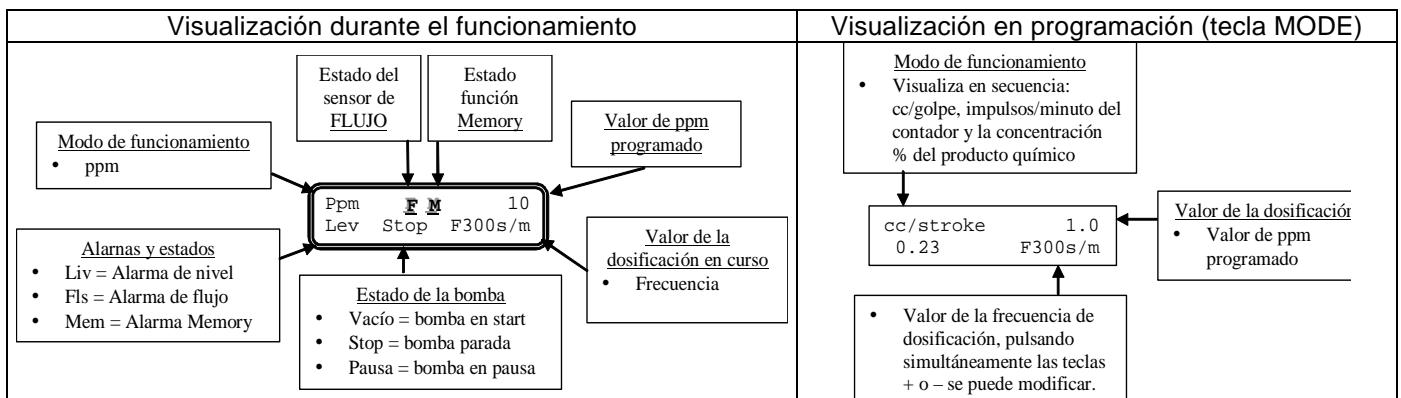
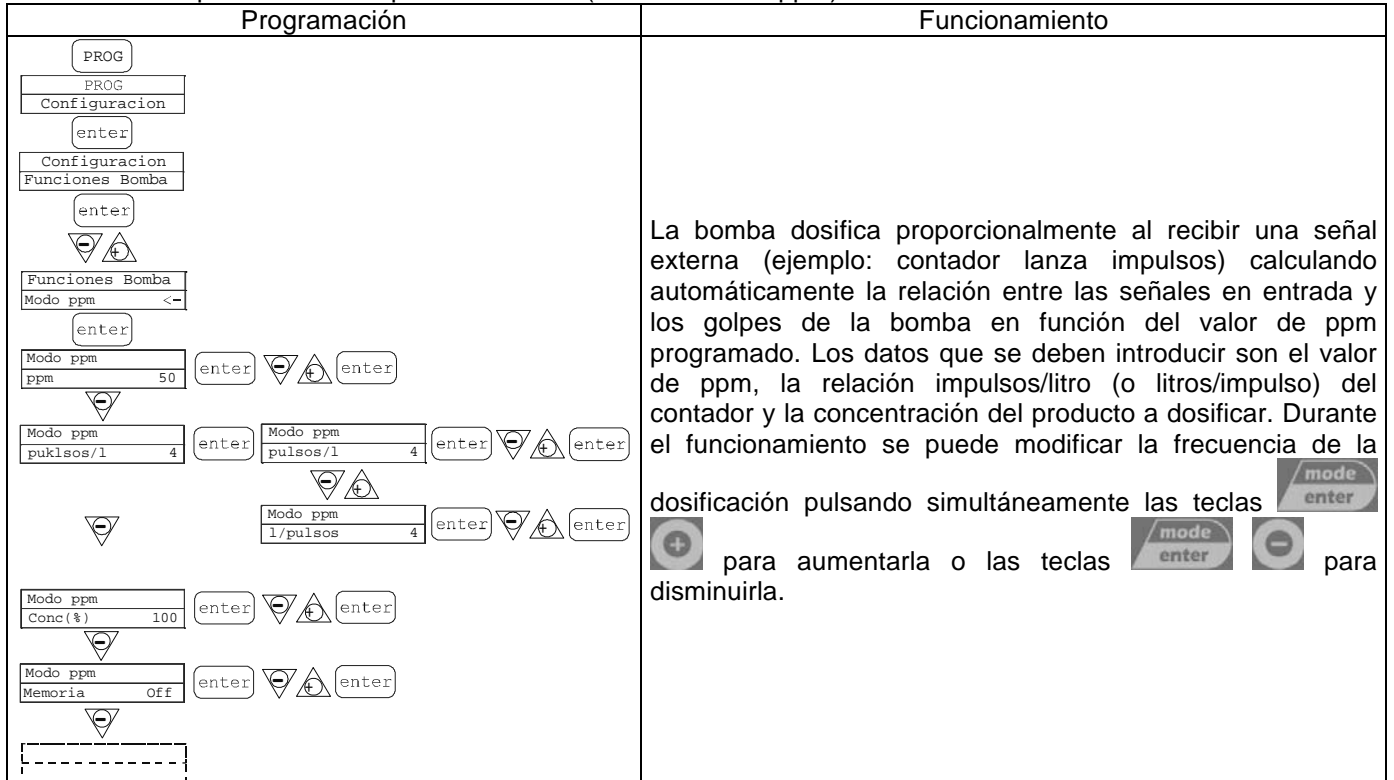

Párrafo 7 – Proporcional con impulsos externos (dosificación en ppm)

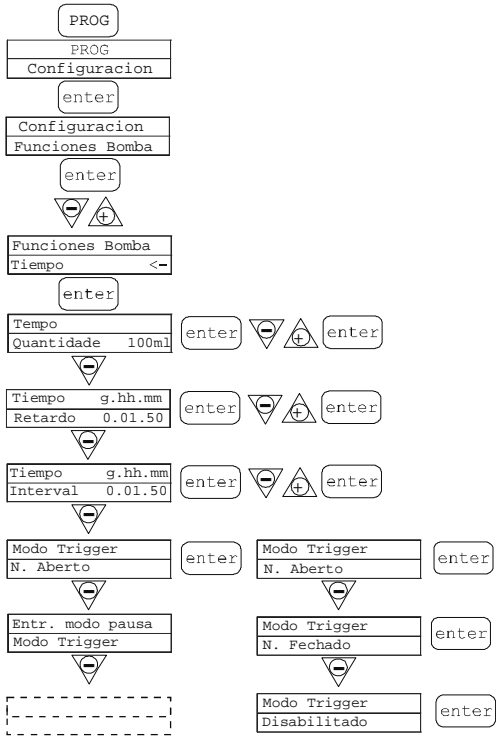
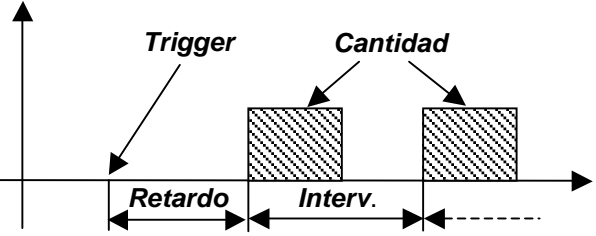
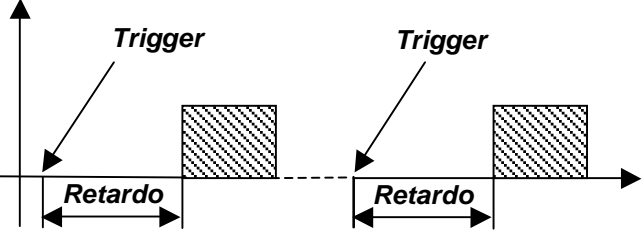

Párrafo 8 – Dosificación temporizada (*Entrada señal de frecuencia “TRIGGER” activada*)

Programación	Funcionamiento
	<p>Después de recibir la señal de TRIGGER programada, la bomba dosifica una cantidad programable en ml. Es posible programar un tiempo de retardo antes de la dosificación (Retardo) y la distancia entre dosificaciones sucesivas (Interv.) como se ilustra en el esquema:</p>  <p>Por ejemplo, programando un tiempo Interv.= 0 se obtiene un sistema en el que la cantidad programada es dosificada después de cada señal de TRIGGER (con el posible retardo programado):</p>  <p>También puede ponerse en marcha la dosificación pulsando la tecla +, que prácticamente simula la señal de Trigger. La señal Trigger puede programarse en N. Aberto (se activa cuando la entrada pasa del modo abierto al cerrado) o en N. Fechado (se activa cuando la entrada pasa del modo cerrado al abierto). La señal Trigger permanece bloqueada durante la dosificación (su recepción no es memorizada ni gestionada). La entrada Pausa (Entrada mando a distancia) no puede ser programada y su activación bloquea la dosificación, mientras que la siguiente desactivación vuelve a poner el sistema en estado de espera de la señal Trigger para efectuar una nueva dosificación.</p> <p>Durante el funcionamiento de la bomba se puede modificar la frecuencia de dosificación pulsando simultáneamente las teclas  para aumentar la frecuencia o las teclas  para disminuirla.</p>

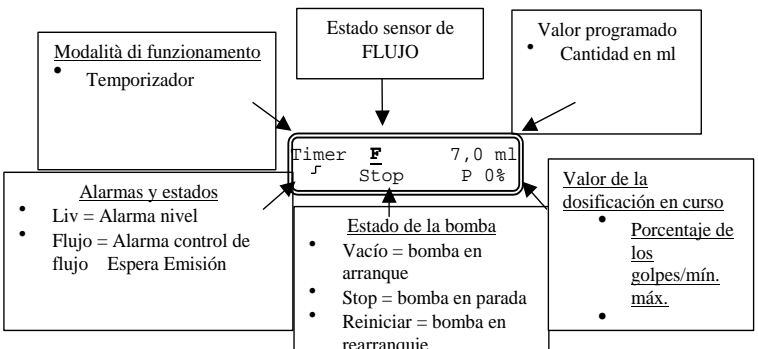
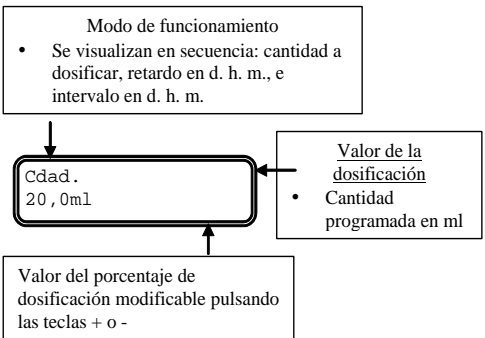
Visualización durante el funcionamiento	Visualización en programación (tecla MODE)
	

Párrafo 8 – Dosificación temporizada (*Entrada señal de frecuencia “TRIGGER”no activada*)

Programación	Funcionamiento
<pre> graph TD A[PROG] --> B[PROG Configuración] B -- enter --> C[Configuración Funciones Bomba] C -- enter --> D[Funciones Bomba Tiempo <-] D -- enter --> E[Tiempo Quantita 100ml] E -- enter --> F[Tiempo g.hh.mm Retardo 0.01.50] F -- enter --> G[Tiempo g.hh.mm Interval 0.01.50] G -- enter --> H[Modo Trigger Desabilitado] H -- enter --> I[Entr. modo pausa Restart Temp] I -- enter --> J[Entr. modo pausa Bloquea tiempo] J -- enter --> K[Entr. modo pausa Pausa dosif.] </pre>	<p>La bomba dosifica una cantidad que se puede programar en ml; se puede programar un tiempo de retardo para la puesta en marcha de la bomba (Retardo) y la distancia entre dos dosificaciones sucesivas (Interv.), como se muestra en el esquema:</p> <p>Los tiempos de Retardo y de Interv son en d.h.m. (días, horas, minutos).</p> <p>La entrada de la Pausa puede programarse de tres modos distintos:</p> <ol style="list-style-type: none"> 1. Bloquea tiempo: con la pausa activada, el sistema bloquea el conteo del tiempo actual y lo reanuda cuando se desactiva la pausa. 2. Pausa dosificación: con la pausa activada, el sistema sigue contando el tiempo y bloquea la dosificación 3. Restart temp: con la pausa activada, el sistema bloquea la dosificación y al desactivarse la pausa el conteo empieza de nuevo desde el principio. <p>Durante el funcionamiento de la bomba se puede modificar la frecuencia de dosificación pulsando simultáneamente las teclas para aumentar la frecuencia o las teclas para disminuirla.</p>
<p>Visualización durante el funcionamiento</p>	<p>Visualización en programación (tecla MODE)</p>

Párrafo 9 – Programación del caudal máximo

Programación	Funcionamiento
	<p>Permite programar el caudal máximo que la bomba puede alcanzar; el modo programado (% o frecuencia) se vuelve la visualización del caudal en la unidad de medida estándar.</p> <p>Pulsando la tecla se accede a la modificación, después con las teclas se programa el valor. Con la tecla se confirma y se vuelve al menú principal.</p>

Párrafo 10 – Programación del relé de alarma

Programación	Funcionamiento
	<p>En ausencia de una situación de alarma se puede programar abierto (fábrica) o cerrado. Pulsando la tecla se accede a la modificación, después con las teclas se programa el valor. Con la tecla se confirma y se vuelve al menú principal.</p>

Párrafo 11 – Calibración del caudal

Programación	Funcionamiento
	<p>En el menú principal aparece el valor de cc por golpe en memoria. Se puede calibrar en dos modos:</p> <p>MANUAL – Introduciendo manualmente el valor de cc cada golpe con las teclas y confirmando con la tecla .</p> <p>AUTOMÁTICA – La bomba realiza 100 golpes, poner en marcha y confirmar con la tecla al final introducir la cantidad aspirada por la bomba con las teclas y confirmar con la tecla . El dato introducido será utilizado en los cálculos de los caudales.</p>

Párrafo 12 – Estadísticas

Programación	Funcionamiento
	<p>En el menú principal visualiza las horas de funcionamiento de la bomba, pulsando la tecla se accede a las demás estadísticas:</p> <ul style="list-style-type: none"> - <i>Strokes</i> = Número de golpes realizados por la bomba. - <i>Q.ty</i> (L) = Cantidad dosificada por la bomba expresada en litros; este valor se calcula en base al valor <i>cc/stroke</i> en memoria. - <i>Power</i> = Número de puestas en marcha de la bomba. - <i>Reset</i> = Con las teclas se pueden poner en cero (YES) o no (NO) los contadores, con la tecla se confirma. Pulsando la tecla se vuelve al menú principal.

Párrafo 13 - Password

Programación	Funcionamiento
<p>The flowchart shows the steps to enter the password programming menu. It starts with 'PROG', followed by 'PROG Configuración'. A dashed box indicates a selection step. Then, the 'Password' field is shown with '*****'. Pressing 'enter' leads to the 'Password' field with '0000'. A dashed box indicates another selection step, followed by another dashed box.</p>	<p>Introduciendo la password se puede entrar en programación y ver todos los valores programados, pero cada vez que se quieran modificar será solicitada la password. La línea parpadeante indica el número que se puede modificar, con la tecla se selecciona el número (de 1 a 9), con la tecla se selecciona el número a modificar y con la tecla se confirma. Programando "0000" (fábrica) la password queda excluida.</p>

Párrafo 14 – Alarma de flujo

Programación	Funcionamiento
<p>The flowchart details the programming of flow alarm settings. It starts with 'PROG' and 'PROG Configuración'. A dashed box indicates a selection step. The 'Alarma Caudal' is set to 'off', then 'on'. The 'Alarma Caudal-On Num.Senales' is set to '1'. The 'Alarma Caudal Recuperacion Num.Senales' is set to '10'. Finally, 'Alarma Caudal' is set back to 'off'. A dashed box indicates a return step.</p>	<p>Permite activar (desactivar) el sensor de flujo. Una vez activado (ON) pulsando la tecla se accede a la solicitud de cuántas señales espera la bomba antes de entrar en alarma. Pulsando la tecla el número parpadea, con las teclas se puede programar el valor. Con la tecla se confirma. Pulsando la tecla se vuelve al menú principal. Sólo en la modalidad Batch se puede activar la modalidad Recuperación. La bomba repite el número de golpes no detectados por el sensor de flujo. Presionando la tecla se accede a la solicitud del número máximo de señales que la bomba puede recuperar antes de ponerse en alarma. Presionando parpadea el número, por lo tanto, con las teclas configuro el valor. Con confirmo. Presionando vuelvo al menú principal.</p>

Párrafo 15 – Alarma de nivel

Programación	Funcionamiento
<p>The flowchart shows the programming of level alarm settings. It starts with 'PROG' and 'PROG Configuración'. A dashed box indicates a selection step. The 'Alarma Nivel' is set to 'Stop', then 'Alarma'. Pressing 'enter' leads to 'Alarma Nivel Alarma'. Pressing 'ESC' returns to the main menu.</p>	<p>Permite programar la bomba cuando se activa la alarma del sensor de nivel, es decir se bloquea la dosificación (Stop) o simplemente activa la señal de alarma sin bloquear la dosificación. Pulsando la tecla se accede a la modificación, con las teclas se puede programar el tipo de alarma. Con la tecla se confirma. Pulsando la tecla se vuelve al menú principal.</p>

Párrafo 16 – Unidad de visualización del caudal

Programación	Funcionamiento
<p>The diagram shows the navigation through the menu. It starts with 'PROG' and 'Configuración'. Pressing the down arrow leads to a dashed box. Pressing 'enter' leads to 'Unidades Standard'. Pressing the right arrow leads to 'Unidades L/h'. Pressing 'enter' returns to the dashed box.</p>	<p>Permite programar la unidad de medida de la dosificación con el display en visualización. Pulsando la tecla se accede a la modificación, con las teclas se programa el tipo de unidad de medida, l/h (litros/hora), Gph (galones/hora), ml/m (mililitros/minuto) o estándar (% o frecuencia, según como haya sido programado). Con la tecla se confirma y se vuelve al menú principal.</p>

Párrafo 17 - Programación Pausa

Programación	Funcionamiento
<p>The diagram shows the navigation through the menu. It starts with 'PROG' and 'Configuración'. Pressing the right arrow leads to 'Paus N.Abierto'. Pressing 'enter' leads to a dashed box. Pressing the right arrow leads to 'Paus N.Cerrado'. Pressing 'enter' returns to the dashed box.</p>	<p>Entrada externa de paro de bomba. De fábrica el sistema llega configurado como Normalmente Abierto.</p> <p>Pulsando la tecla se accede a la modificación, después con las teclas se programa el valor (N. ABIERTO o N. CERRADO.)</p> <p>Con la tecla se confirma y se vuelve al menú principal.</p>

Ajuste contraste display

Para ajustar el contraste del display mantener presionada la tecla y dentro de 5 segundos presionar las teclas o para aumentar o disminuir el contraste

Alarmas

Visualización	Causa	Interrupción
<p>Led Alarma fijo Mensaje Lev parpadeante</p> <p>Ej: </p>	<p>Alarma de final del nivel sin interrupción del funcionamiento de la bomba.</p>	<p>Reestablecer el nivel del líquido.</p>
<p>Led Alarma fijo Mensajes Lev y stop parpadeantes</p> <p>Ej: </p>	<p>Alarma final del nivel con interrupción del funcionamiento de la bomba.</p>	<p>Reestablecer el nivel del líquido.</p>
<p>Mensaje Mem parpadeante</p> <p>Ej: </p>	<p>La bomba recibe uno o más impulsos durante la dosificación con la función <i>memory</i> en OFF.</p>	<p>Pulsar la tecla </p>
<p>Mensaje Mem parpadeante</p> <p>Ej: </p>	<p>La bomba recibe uno o más impulsos durante la dosificación con la función <i>memory</i> en ON.</p>	<p>Cuando la bomba termina de recibir los impulsos externos devuelve los golpes memorizados.</p>
<p>Led Alarma fijo Mensaje Flw parpadeante</p> <p>Ej: </p>	<p>Alarma de flujo activa, la bomba no ha recibido el número de señales programadas por el sensor de flujo.</p>	<p>Pulsar la tecla </p>
<p>Ej: </p>	<p>Error de comunicación interna de la CPU.</p>	<p>Pulsar la tecla para reestablecer los parámetros de <i>default</i>.</p>





Panneau de contrôle – DOSATec LMS



	Accès au menu de programmation
	Pendant la phase de fonctionnement de la pompe: si cette touche est enfoncée elle affiche à des intervalles réguliers les valeurs programmées; si elle est enfoncée en même temps que les touches elle augmente ou réduit une valeur dépendant du mode de fonctionnement choisi. Au cours de la programmation, elle fait fonction de "enter", c'est-à-dire qu'elle confirme l'entrée dans les différents niveaux de menu et les modifications à l'intérieur de ces derniers.
	Fait démarrer et met à l'arrêt la pompe. Dans les conditions d'alarme de niveau (unique fonction d'alarme), de flux et de mémoires actives, elle désactive la signalisation sur l'afficheur.
	Pour "quitter" ces différents niveaux de menu. Avant de quitter définitivement la programmation, on accède à la demande d'enregistrement des modifications
	Fait défiler les menus vers le haut ou augmente les valeurs numériques à modifier. En mode de fonctionnement Batch, elle peut faire démarrer le dosage.
	Fait défiler les menus vers le bas, ou réduit les valeurs numériques à modifier.
	Led verte clignotante pendant le dosage.
	Led rouge qui s'allume dans les différentes situations d'alarme.

Connexions électriques

	1	Relais Alarme	
	2		
	3	Pole +	Entrée signal 4-20 mA Impédance D'Entrée: 200 ohm
	4	Pole -	
	5	-Entrée commande à distance (start-stop)	
	6	-Entrée Pausa signal	
	7	-Entrée signal fréquence (compteur émetteur d'impulsions)	
	8	-Entrée Detente externo	
	9	Entrée capteur de débit	
	10		
B	Entrée sonde de niveau		

Appuyer sur la touche  pendant plus de trois secondes pour allumer la programmation. Avec les touches   il est possible de faire défiler les options du menu, la touche  permet d'accéder aux modifications.

La pompe est programmée en usine en mode constant. La pompe reprend automatiquement le mode de fonctionnement après 1 minute de non-activité. Dans ce cas, les données éventuellement introduites ne sont pas enregistrées. La touche  permet de quitter les niveaux de la programmation. À la sortie de la programmation, l'afficheur visualise :

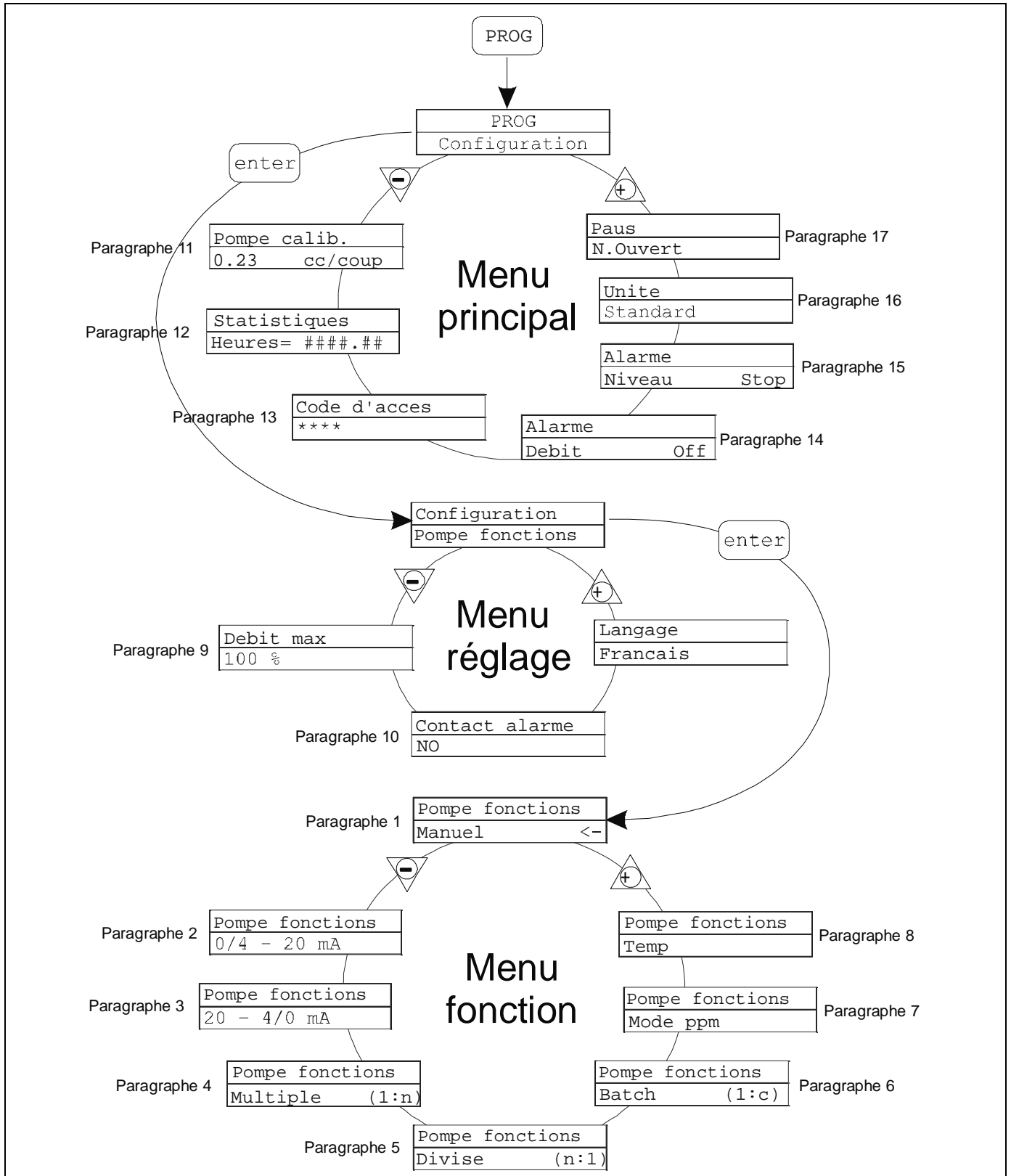
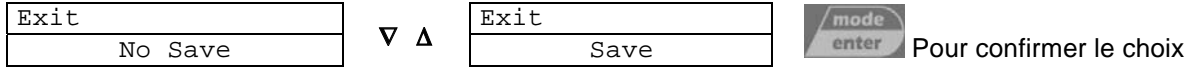

Programmation de la langue

Programmation	Fonctionnement
<pre> graph TD A[PROG] --> B[PROG Configuration] B --> C[enter] C --> D[Configuration Pump Functions] D --> E[Max flow rate P100%] E --> F[Alarm Relay N.Open] F --> G[Language English] G --> H[enter] H --> I[] style I stroke-dasharray: 5 5 </pre>	<p>Permet de sélectionner la langue, la pompe est programmée en usine en anglais.</p> <p>Appuyer sur pour accéder à la modification, puis sur les touches pour programmer la valeur. La touche confirme et permet de retourner au menu principal.</p>

Paragraphe 1 – Dosage manuel

Programmation	Fonctionnement
<pre> graph TD A[PROG] --> B[PROG Configuration] B --> C[enter] C --> D[Configuration Fonctions pompe] D --> E[enter] E --> F[Fonctions pompe Manuel <-] F --> G[enter] G --> H[] style H stroke-dasharray: 5 5 </pre>	<p>La pompe travaille en mode constant et le débit peut être réglé uniquement en mode manuel en appuyant simultanément sur les touches pour augmenter le débit ou sur les touches pour le réduire.</p>

Affichage pendant le fonctionnement	Affichage lors de la programmation (touche MODE)
<pre> graph TD A[Mode de fonctionnement • Man = Manuelle] --> D B[État capteur de FLUX] --> D C[Valeur du dosage en cours (dépend de l'unité de mesure sélectionnée) • Pourcentage, Fréquence, l/h, Gph, ml/m] --> D E[État de la pompe • Vide= pompe au démarrage • Stop = pompe arrêtée • Paus = pompe en pause] --> D F[Alarmes et états • Niv = Alarme niveau • Deb = Alarme flux] --> D D[MAN Niv Stop P100%] </pre>	<pre> graph TD A[Mode de fonctionnement • Affiche la valeur correspondante de la fréquence] --> B[F320s/m P100%] C[Valeur du dosage en cours • Modification du débit maximal en appuyant en même temps sur + ou -] --> B </pre>

Paragraphe 2 – Dosage Proportionnel sur signal 0/4-20 mA

Programmation	Fonctionnement
<pre> graph TD A[PROG] --> B[PROG Configuration] B --> C[enter] C --> D[Configuration Fonctions pompe] D --> E[enter] E --> F[Fonctions pompe 0/4 - 20 mA <-] F --> G[enter] G --> H[0/4 - 20 mA Bas 4.0mA] H --> I[enter] I --> J[0/4 - 20 mA Haut 20.0mA] J --> K[enter] K --> L[] style L stroke-dasharray: 5 5 </pre>	<p>La pompe dose proportionnellement sur un signal (0)4-20 mA. La programmation d'usine de la pompe prévoit l'interruption du dosage à 4 mA et le dosage à la fréquence maximale programmée lorsqu'elle reçoit 20 mA. En cours de programmation, il est possible de modifier ces deux valeurs. La fréquence maximale est modifiable pendant le fonctionnement en appuyant simultanément sur les touches pour augmenter le débit ou sur les touches pour le réduire.</p>

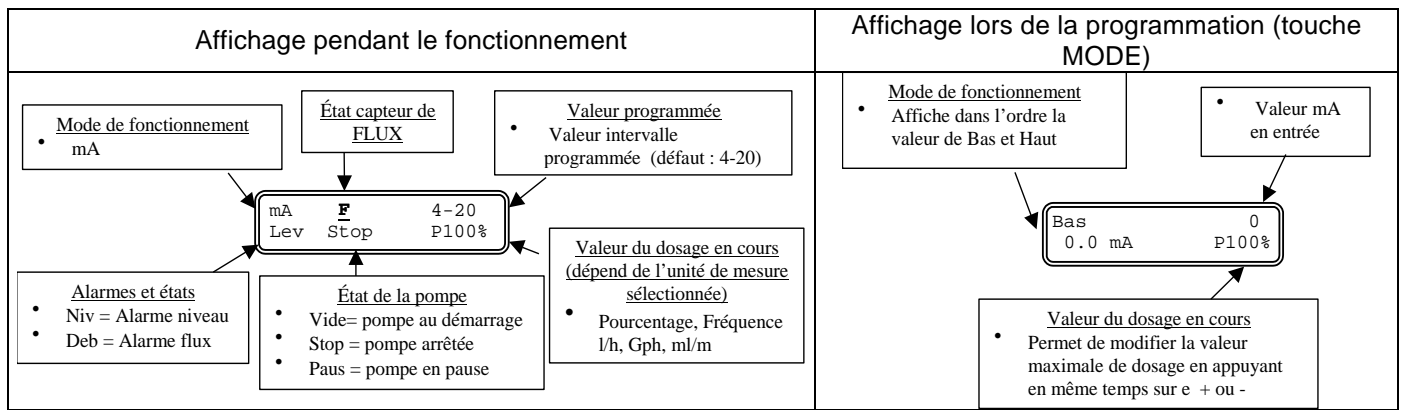

Paragraphe 3 – Dosage proportionnel sur signal 20-4/0 mA

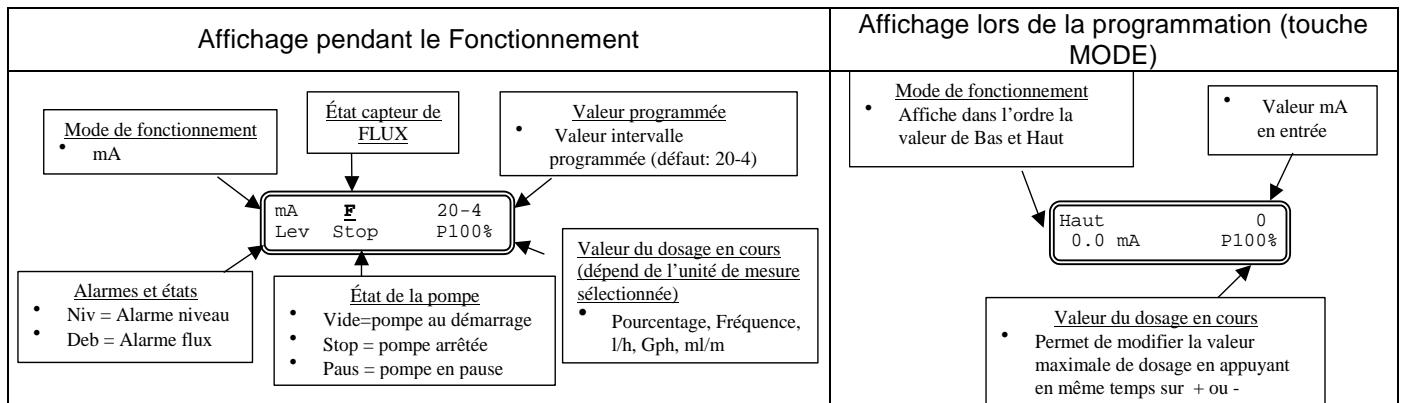
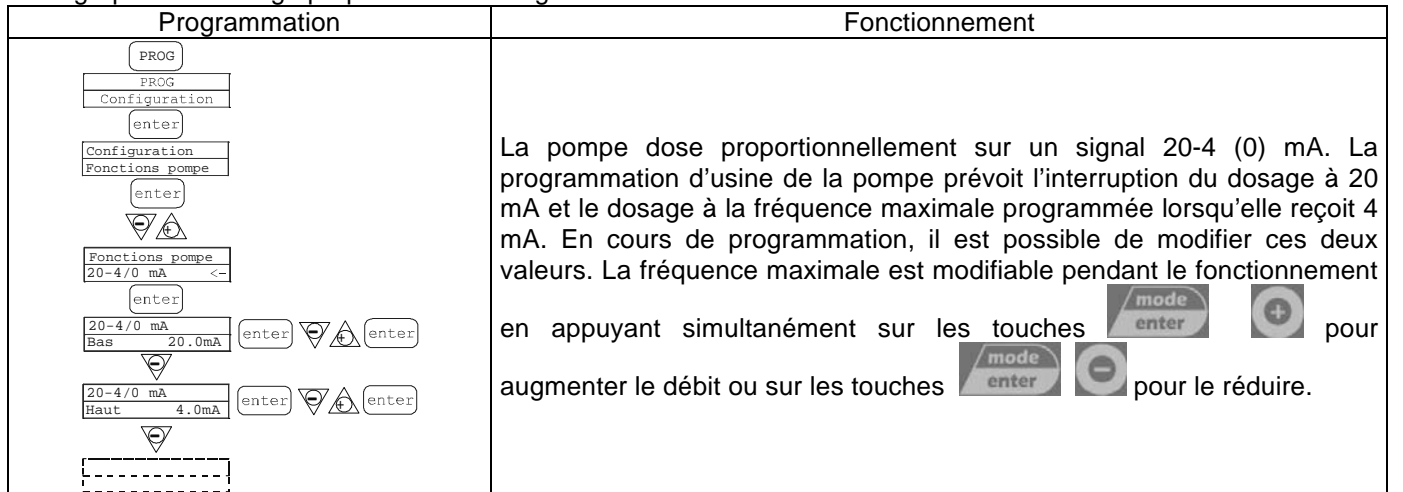

Paragraphe 4 – Proportionnel à des impulsions extérieures (multiplications)

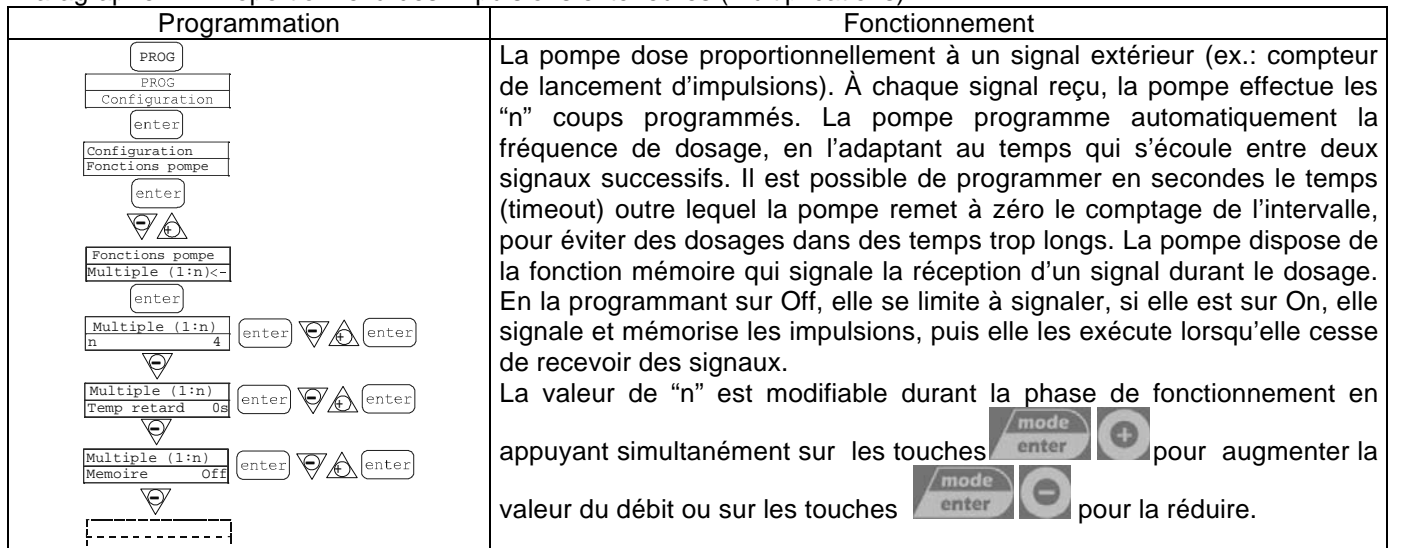

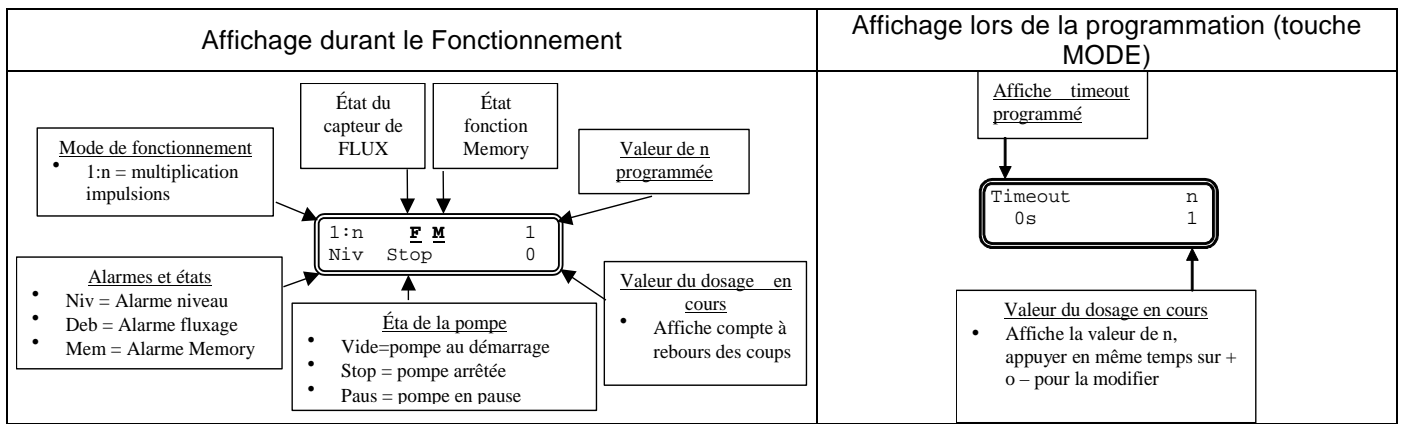

Paragraphe 5 – Proportionnel à impulsions extérieures (division)

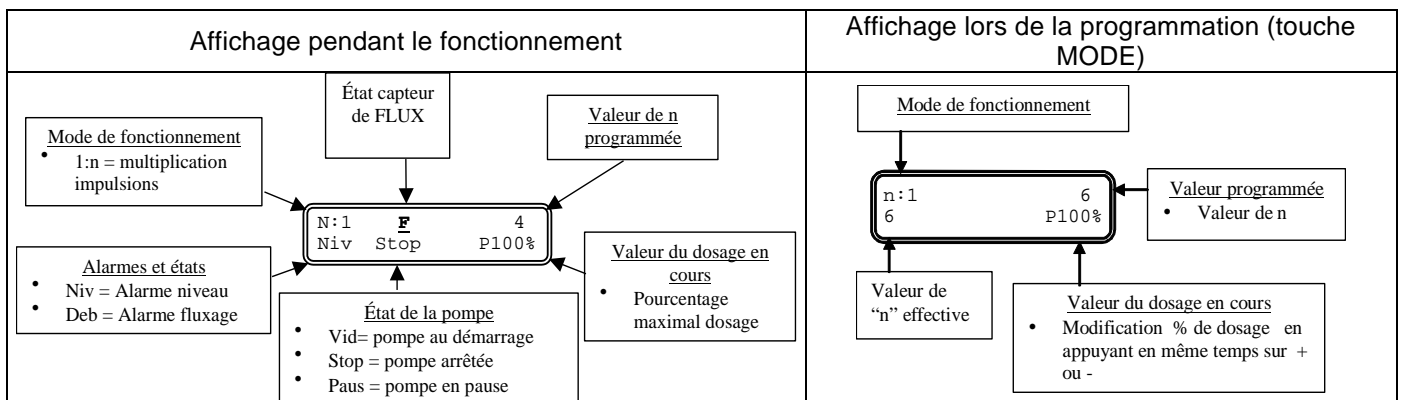
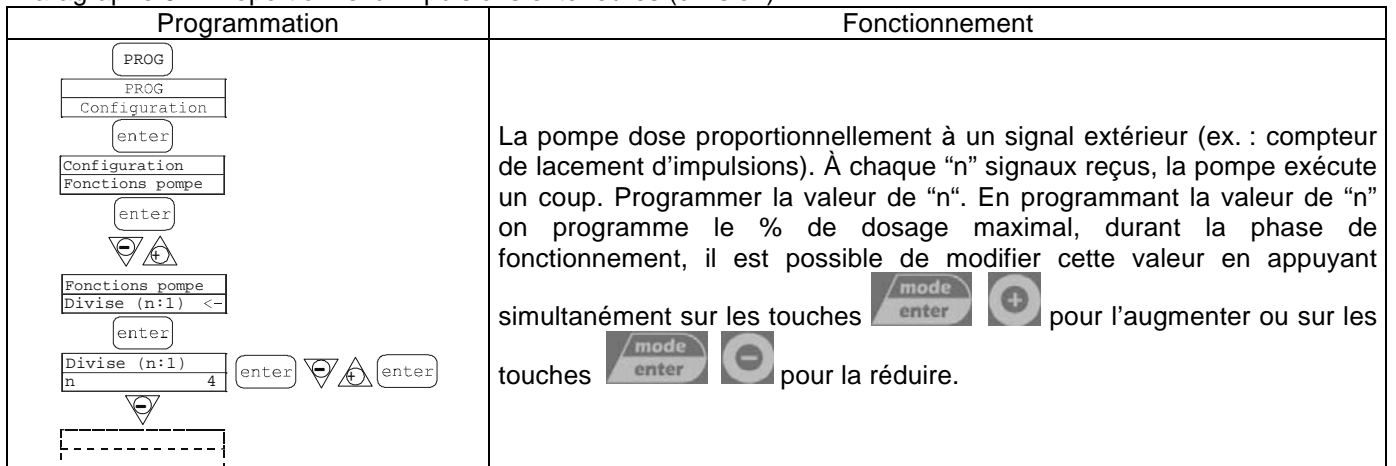

Paragraphe 6 – Proportionnel à impulsions extérieures (dosage Batch)

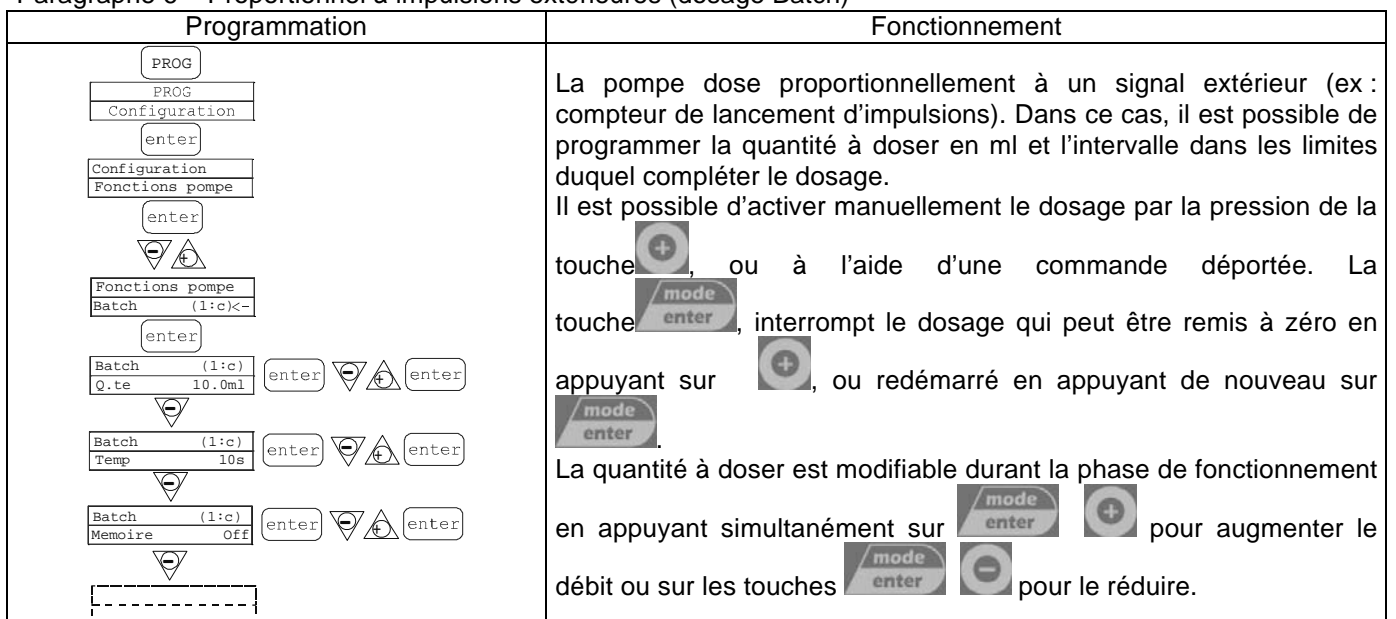

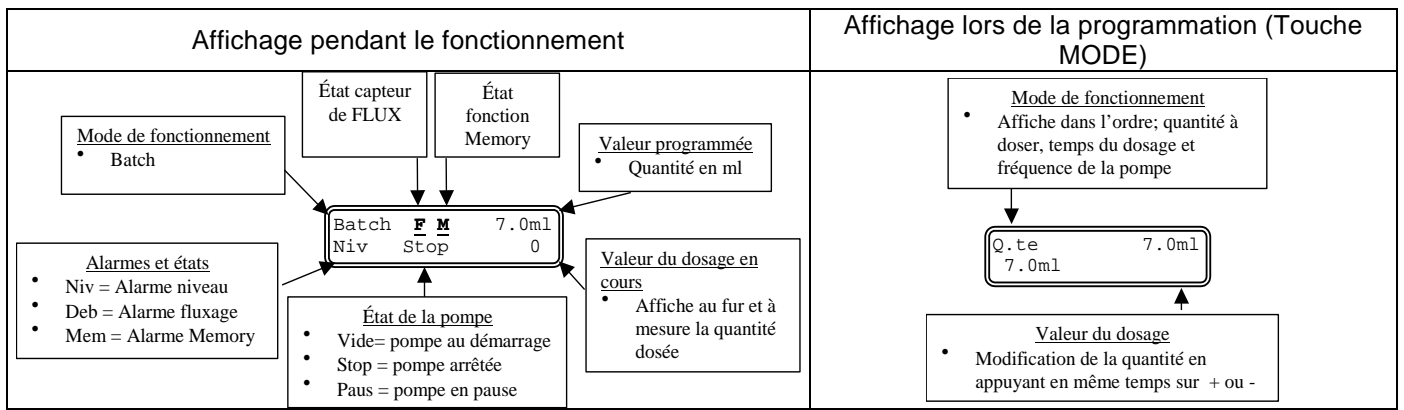



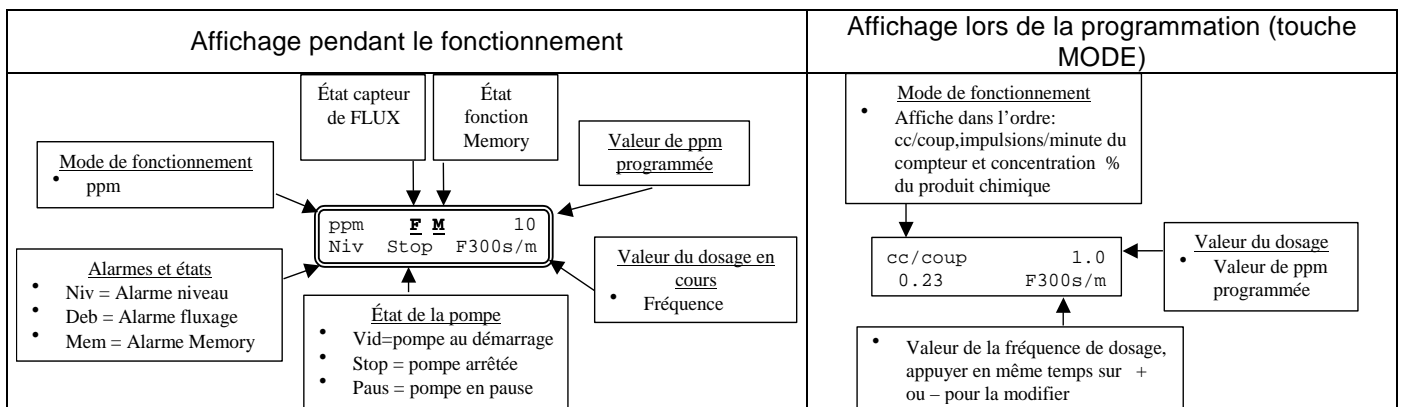
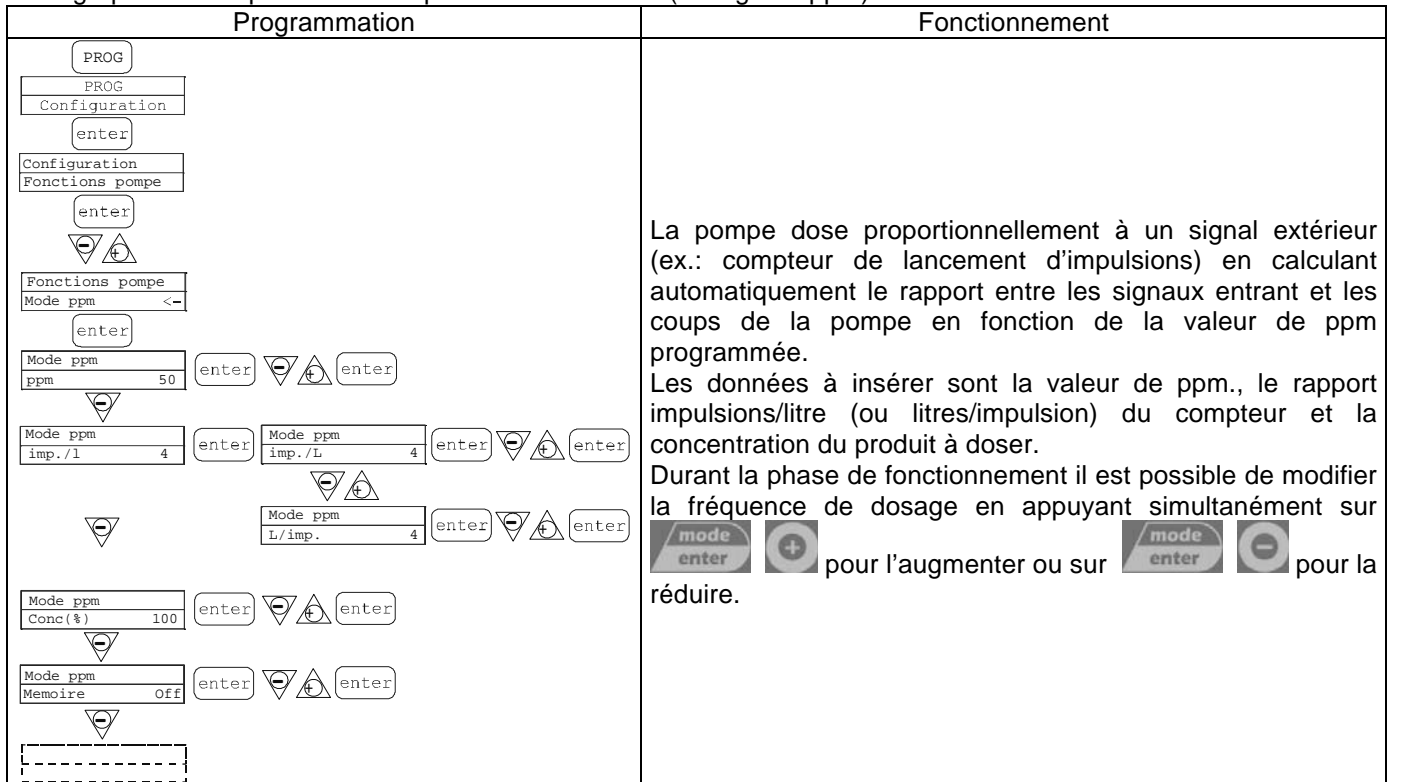

Paragraphe 7 – Proportionnel à impulsions extérieures (dosage en ppm)

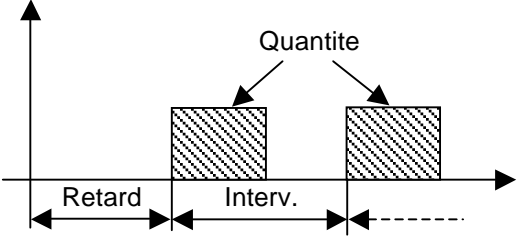

Paragraphe 8 – Dosage temporisé (**Entrée signal fréquence «Trigger» activé**)

Programmation	Fonctionnement
	<p>Après l'arrivée du signal de DETENTE réglé, la pompe dose une quantité programmable en ml. Il est possible de régler un temps de retard avant le dosage (Retard) et la distance entre les dosages successifs (Interv.), comme d'après le schéma:</p> <p>En réglant, par exemple, un temps Interv. = 0 on obtient un système dosant la quantité programmée après chaque signal de DETENTE (avec l'éventuel retard réglé):</p> <p>Il est possible de faire démarrer le dosage même en appuyant sur la touche +, simulant pratiquement le signal de Detente. Le signal Detente peut être réglé NO (il s'active lorsque l'entrée passe du mode ouvert au mode fermé) ou NF (il s'active lorsque l'entrée passe du mode fermé au mode ouvert). Le signal Detente est bloqué pendant le dosage (son arrivée n'est ni mémorisée ni gérée). L'entrée Pause (Entrée commande à distance) ne peut pas être programmée et son activation bloque le dosage, tandis que la désactivation successive remet le système en attente du signal Detente pour un nouveau dosage. Pendant la phase de fonctionnement de la pompe, il est possible de modifier la fréquence du dosage, en appuyant en même temps sur les touches pour augmenter la fréquence, ou bien sur les touches pour la diminuer.</p>
Visualisation pendant le fonctionnement	Visualisation en démarche (touche MODE)

Paragraphe 8 – Dosage temporisé (**Entrée signal fréquence «Trigger» non activé**)

Programmation	Fonctionnement
<p> PROG Configuration enter Configuration Function pompe enter - / + Function pompe Temps <- enter Temps Quantite 100ml enter - / + enter - Temps g.hh.mm Retard 0.01.50 enter - / + enter - Temps g.hh.mm Interval 0.01.50 enter - / + enter - Mode detente Desaffecte' enter - / + enter - Entree Pause Redemarr. Temp enter Entree Pause Redemarr. Temp enter - Entree Pause Blocage du temps enter - Entree Pause Pause Dosage enter </p>	<p> La pompe dose une quantité programmable en ml, il est possible de régler un temps de retard au démarrage de la pompe (Retard) et la distance entre deux dosages successifs (Interv.), comme d'après le schéma: </p>  <p> Les temps de Retard et Interv. sont en jj.hh.mm (jours.heures.minutes) </p> <p> L'entrée Pause peut être programmée en trois modes différents: </p> <ol style="list-style-type: none"> 1. Blocage du temps: avec la pause activée, le système bloque le comptage du temps actuel qui reprend quand la pause se désactive 2. Pause Dosage: avec la pause activée, le système continue à compter le temps et bloque le dosage 3. Redemarr. Temp: avec la pause activée, le système bloque le dosage, quand la pause se désactive le comptage recommence dès le début. <p> Pendant la phase de fonctionnement de la pompe, il est possible de modifier la fréquence du dosage, en appuyant en même temps sur les touches   pour augmenter la fréquence, ou bien sur les touches   pour la diminuer. </p>

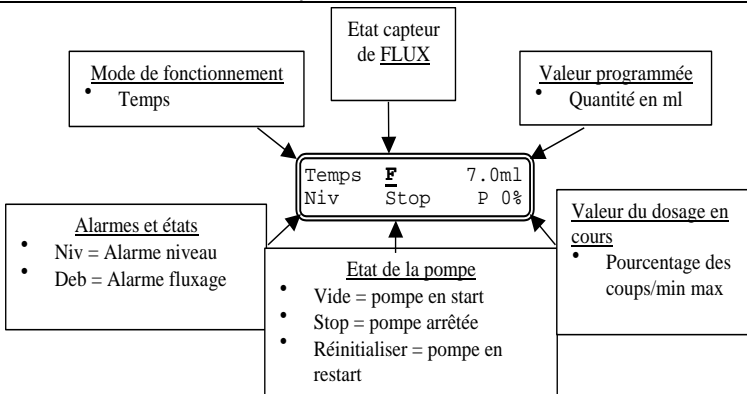
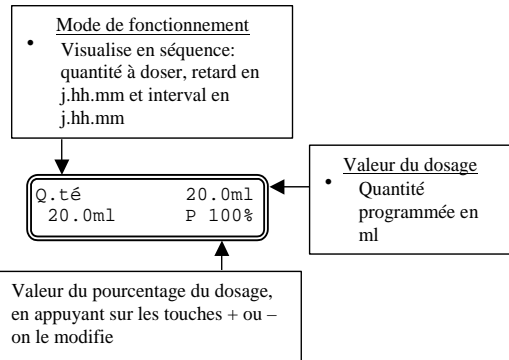
Visualisation pendant le fonctionnement	Visualisation en démarche (touche MODE)
	

Paragraphe 9 – Programmation débit maximal

Programmation	Fonctionnement
	<p>Permet de programmer le débit maximal pouvant être atteint par la pompe et le mode programmé (% ou fréquence) devient l'affichage du débit dans l'unité de mesure standard.</p> <p>Appuyer sur pour accéder à la modification puis sur les touches pour programmer la valeur- Avec confirmer et retourner au menu principal.</p>

Paragraphe 10 – Programmation du relais d'alarme

Programmation	Fonctionnement
	<p>En l'absence d'une situation d'alarme, il peut être programmé ouvert (usine) ou fermé.</p> <p>Appuyer sur pour accéder à la modification puis avec les touches programmer la valeur. Avec confirmer et retourner au menu principal.</p>

Paragraphe 11 – Calibrage du débit

Programmation	Fonctionnement
	<p>Le menu principal affiche la valeur de cc par coup en mémoire. Il est possible de calibrer en deux modes :</p> <p>MANUEL – insérer manuellement la valeur en cc par coup avec les touches et confirmer avec </p> <p>AUTOMATIQUE – la pompe exécute 100 coups qui sont activés avec la touche , une fois terminés, insérer la quantité aspirée par la pompe avec les touches et confirmer avec </p> <p>La donnée insérée sera utilisée dans les calculs des débits</p>

Paragraphe 12 – Statistiques

Programmation	Fonctionnement
	<p>Le menu principal affiche les heures de fonctionnement de la pompe, appuyer sur pour accéder aux autres statistiques.</p> <ul style="list-style-type: none"> - Strokes = nombre de coups exécutés par la pompe - Q.ty(L) = quantité dosée par la pompe exprimée en litres; cette donnée est calculée d'après la valeur cc/stroke en mémoire - Power = nombre de démarrages de la pompe - Reset = les touches permettent de réinitialiser les compteurs (YES) ou non (NO), appuyer sur pour confirmer. <p>La pression de permet de retourner au menu principal.</p>

Paragraphe 16 – Unité affichage débit

Programmation	Fonctionnement
	<p>Permet de programmer l'unité de mesure du dosage sur l'afficheur.</p> <p>Appuyer sur pour accéder à la modification, puis appuyer sur pour programmer le type d'unité de mesure, L/h (Litres/heure), Gph (Gallons/heure), ml/m (millilitres/minute) ou standard (% ou fréquence selon la programmation), Appuyer sur pour confirmer et retourner au menu principal</p>

Paragraphe 17 - Programmation Pause

Programmation	Fonctionnement
	<p>Entrée signal pour mettre la pompe en pause. Le système est réglé d'usine en Normalement Ouvert.</p> <p>Appuyer sur pour accéder à la modification puis avec les touches programmer la valeur (N. OUVERT ou N. FERME'). Avec confirmer et retourner au menu principal.</p>

Régulation contraste affichage

Pour la régulation du contraste de l'affichage tenir appuyée la touche et dans 5 secondes appuyer sur les touches pour augmenter ou diminuer le contraste.

Alarmes

Affichage	Cause	Interruption
<p>Led Alarme fixe Message lev clignotant</p> <p>Ex: </p>	Alarme fin de niveau, sans interruption du fonctionnement de la pompe	Rétablissement du niveau du liquide
<p>Led Alarme fixe Message lev et stop clignotant</p> <p>Ex: </p>	Alarme fin de niveau, avec interruption du fonctionnement de la pompe	Rétablissement du niveau du liquide
<p>Message Mem clignotant</p> <p>Ex: </p>	La pompe reçoit une ou plusieurs impulsions durant le dosage avec la fonction Mémoire sur Off	Pression de la touche
<p>Message Mem clignotant</p> <p>Ex: </p>	La pompe reçoit une ou plusieurs impulsions durant le dosage avec la fonction Mémoire sur On	Lorsque la pompe cesse de recevoir les impulsions extérieures, elle rend les coups mémorisés.
<p>Led Alarme fixe Message Flw clignotant</p> <p>Ex: </p>	Alarme de flux active, la pompe n'a pas reçu le nombre de signaux programmés par le capteur de flux.	Pression de la touche
<p>Ex: </p>	Erreur de communication interne de l'UC.	Pression de la touche pour rétablir les paramètres de défaut.



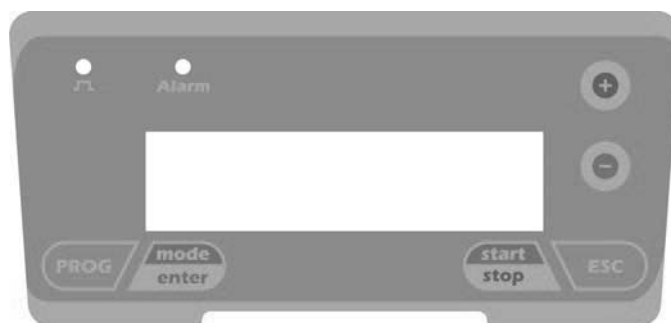

Pannello di controllo – DOSATec LMS



	Accesso al menu di programmazione.
	Durante la fase di funzionamento della pompa: premuto visualizza ciclicamente sul display i valori programmati; Premuto contemporaneamente ai pulsanti aumenta o decrementa un valore dipendente dalla modalità di funzionamento prescelta. In programmazione svolge la funzione “enter”, cioè conferma l’ingresso nei vari livelli di menu e le modifiche all’interno degli stessi.
	Avvia e mette in fase di stop la pompa. Nelle condizioni di allarme di livello (sola funzione allarme), di flusso e memory attive, disattiva la segnalazione sul display.
	Per “uscire” dai vari livelli di menu. Prima di uscire definitivamente dalla programmazione si accede alla richiesta di salvataggio delle modifiche.
	Scorre i menu verso l’alto, oppure incrementa i valori numerici da modificare. Nella modalità Batch può avviare il dosaggio.
	Scorre i menu verso il basso, oppure decrementa i valori numerici da modificare.
	Led verde lampeggiante durante il dosaggio.
	Led rosso che si accende nelle varie situazioni d’allarme.

Connessioni elettriche

	1	Relè d’allarme		
	2			
	3	Polo +	Ingresso 4-20 mA Impedenza d’ingresso: 200 ohm	
	4	Polo -		
	5	-Ingresso controllo remoto (start-stop)		
	6	-Ingresso segnale Pausa		
	7	-Ingressi segnale in frequenza (contatore lancia-impulsi)		
	8	-Ingresso trigger esterno		
	9	Ingressi sensore di flusso		
	10			
B	Ingresso sonda controllo livello			

Premendo il tasto  per più di tre secondi si accede alla programmazione. Con i tasti   potrete scorrere le voci del menu, con il pulsante  si accede alle modifiche. Di fabbrica la pompa è programmata in modalità costante. La pompa torna automaticamente nella modalità di funzionamento dopo 1 minuto di non attività. In questo caso dati eventualmente inseriti non vengono salvati.

Con il pulsante  si esce dai livelli della programmazione. All'uscita dalla programmazione il display visualizza:

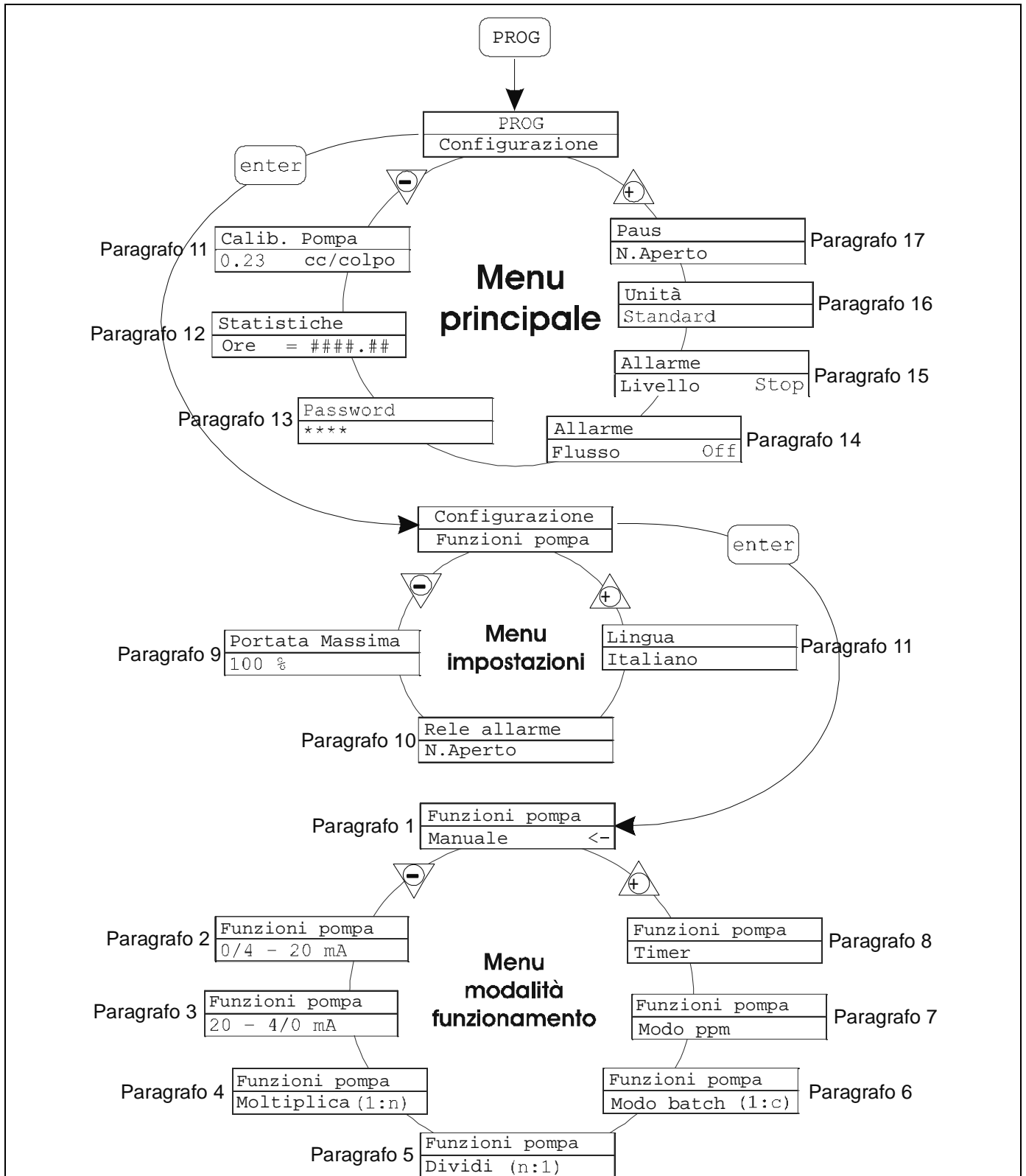
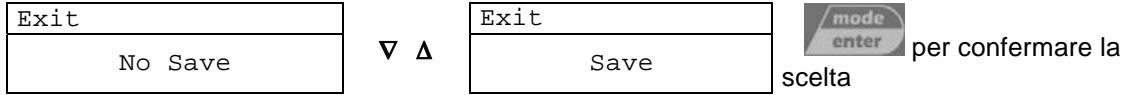

Impostazione lingua

Programmazione	Funzionamento
	<p>Permette di selezionare la lingua, di fabbrica la pompa è impostata in inglese.</p> <p>Premendo si accede alla modifica, quindi con i tasti imposto il valore. Con confermo e torno al menu principale</p>

Paragrafo 1 – Dosaggio manuale

Programmazione	Funzionamento
	<p>La pompa lavora in modalità costante. La portata è regolata manualmente premendo contemporaneamente i pulsanti per aumentare il valore della portata, oppure i pulsanti per diminuirlo.</p>

Visualizzazione durante il funzionamento	Visualizzazione in impostazione (tasto MODE)

Paragrafo 2 – Dosaggio Proporzionale a segnale 0/4-20 mA

Programmazione	Funzionamento
	<p>La pompa dosa proporzionalmente ad un segnale (0)4-20 mA. Di fabbrica la pompa interrompe il dosaggio a 4 mA e dosa alla massima frequenza impostata quando riceve 20 mA. In programmazione è possibile modificare questi due valori. La frequenza massima è modificabile durante il funzionamento, premendo contemporaneamente i tasti per aumentare la portata, oppure i pulsanti per diminuirla.</p>

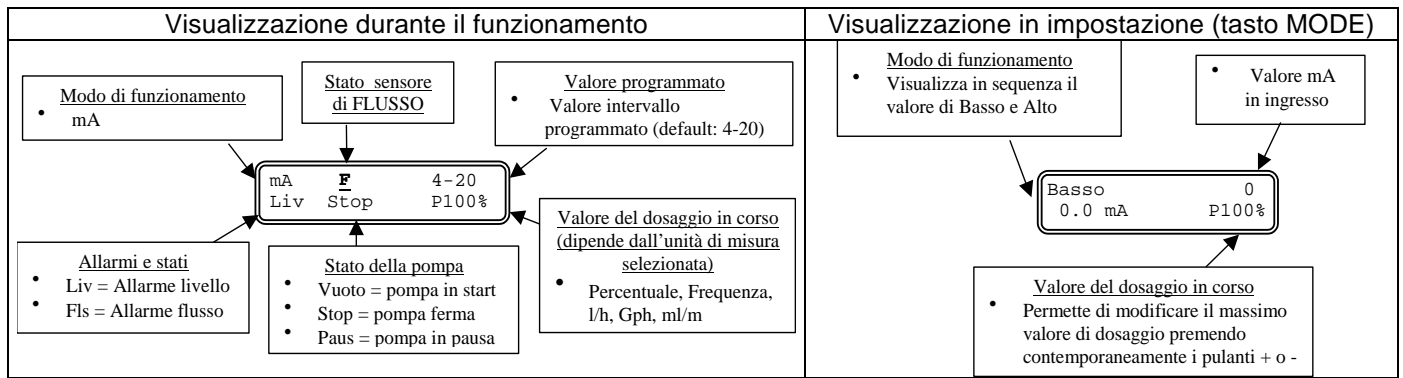

Paragrafo 3 – Dosaggio Proporzionale a segnale 20-4/0 mA

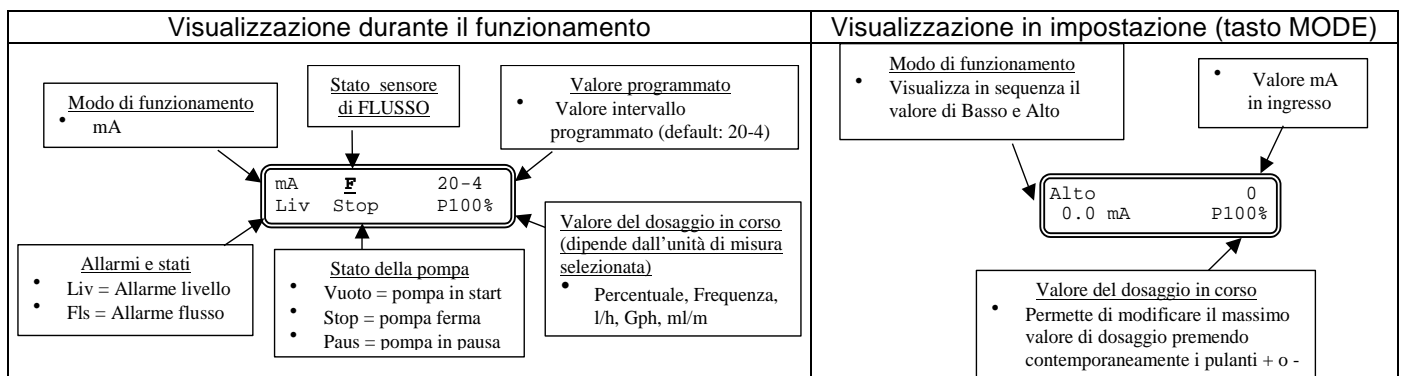
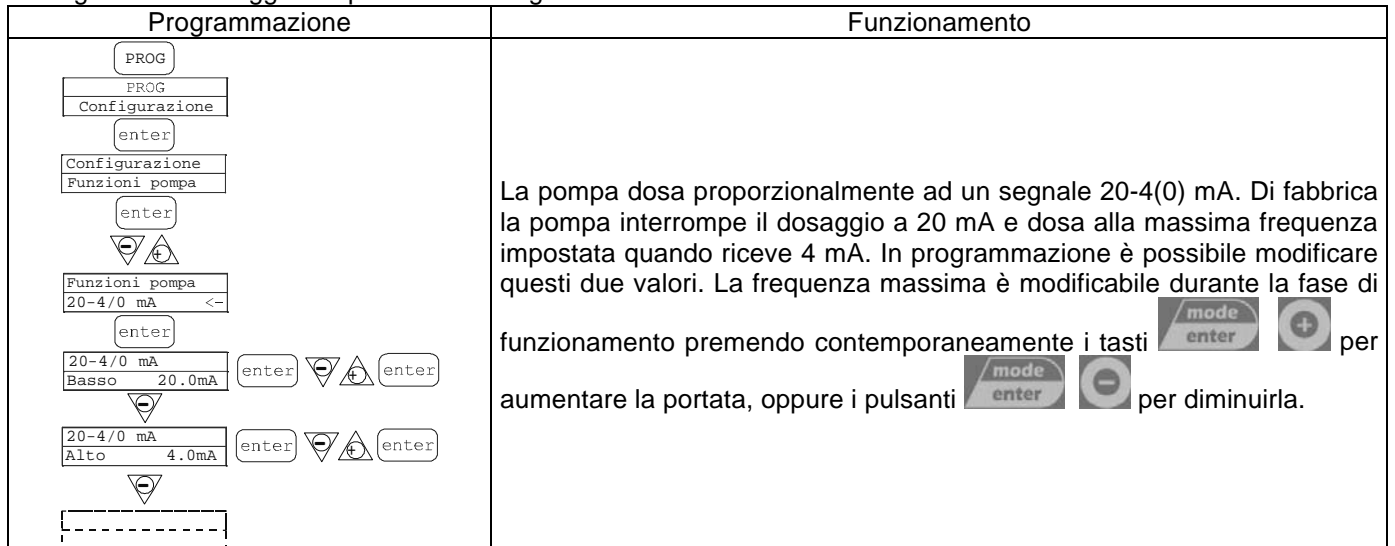

Paragrafo 4 – Proporzionale ad impulsi esterni (moltiplicazione)

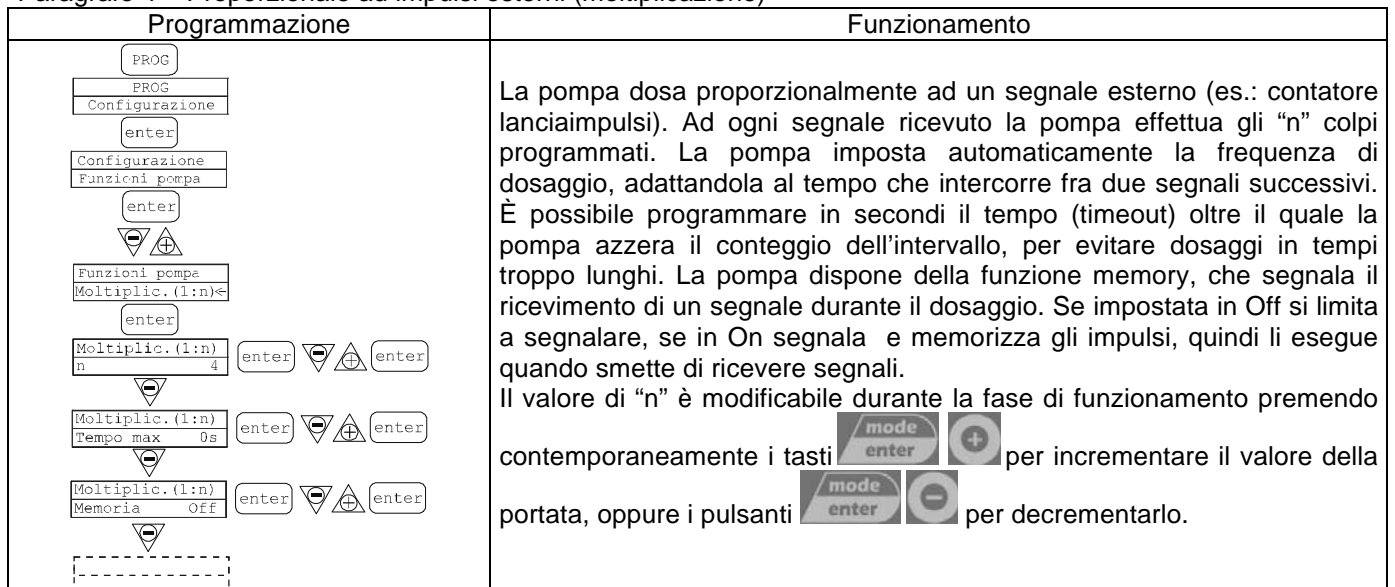

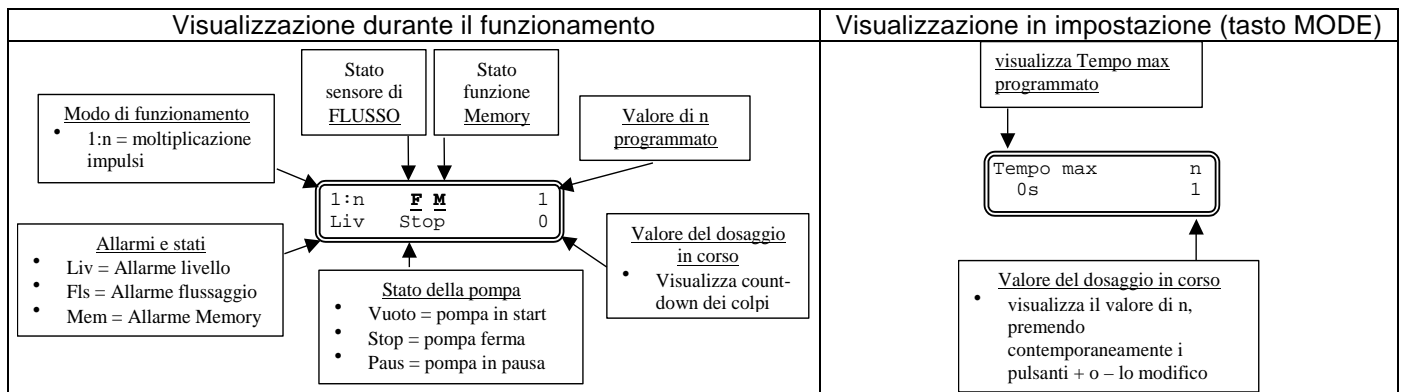

Paragrafo 5 – Proporzionale ad impulsi esterni (divisione)

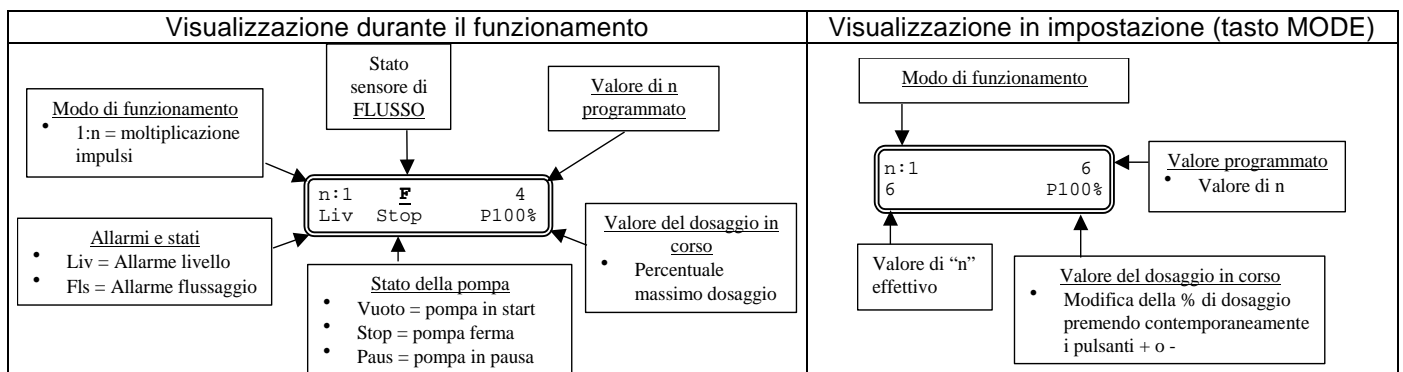
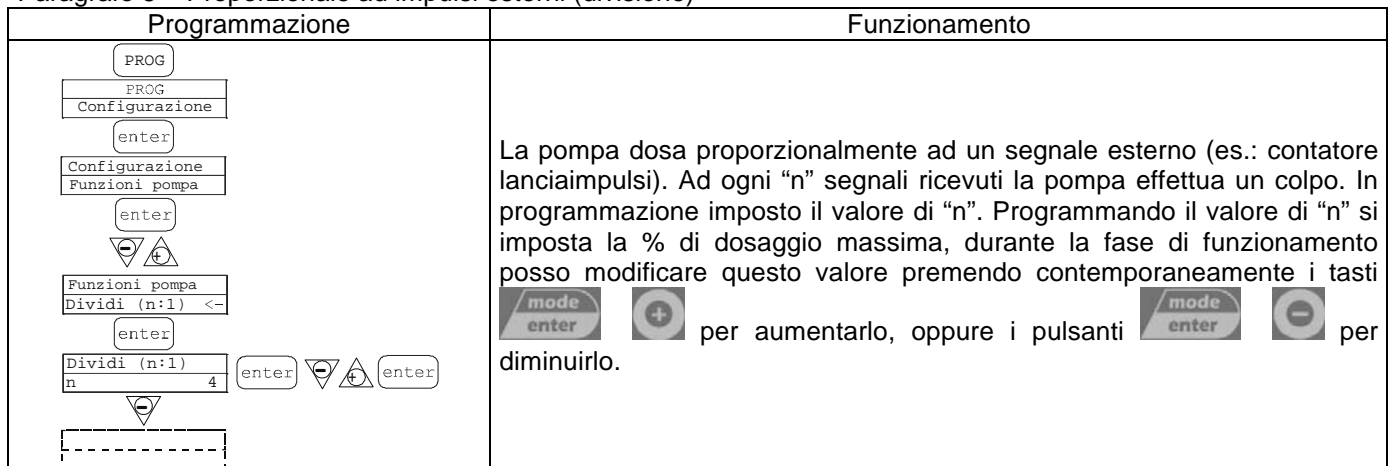

Paragrafo 6 – Proporzionale ad impulsi esterni (dosaggio batch)

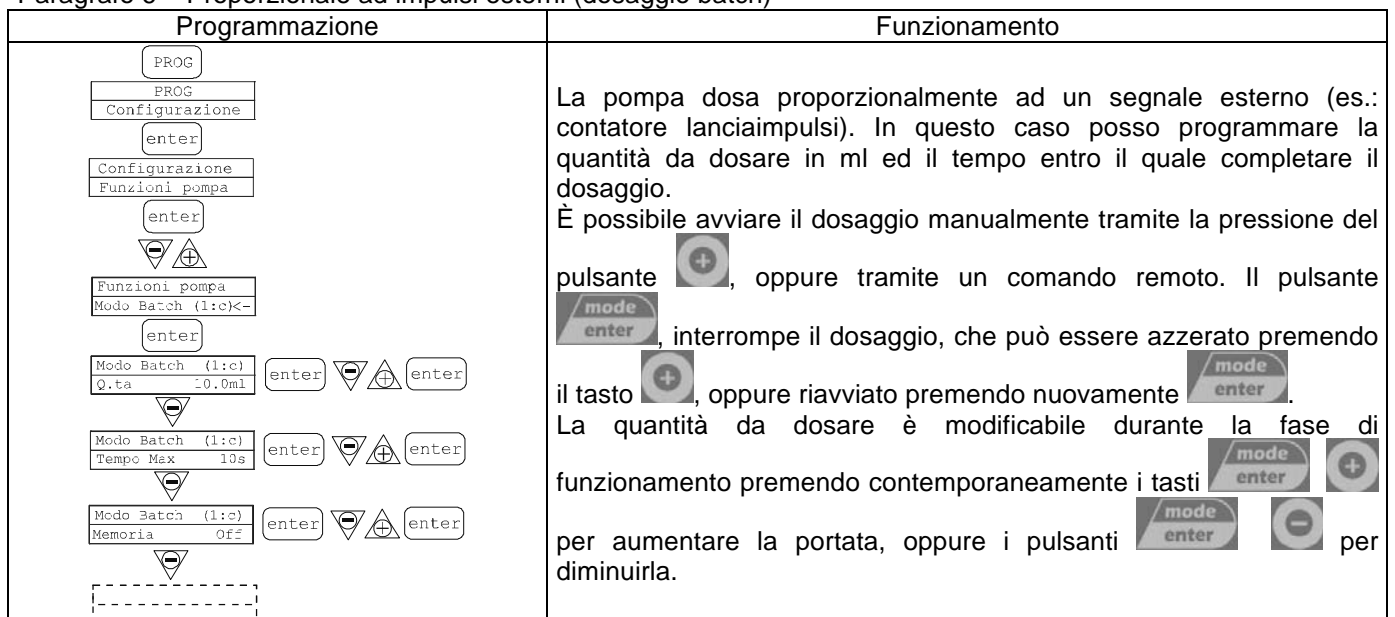

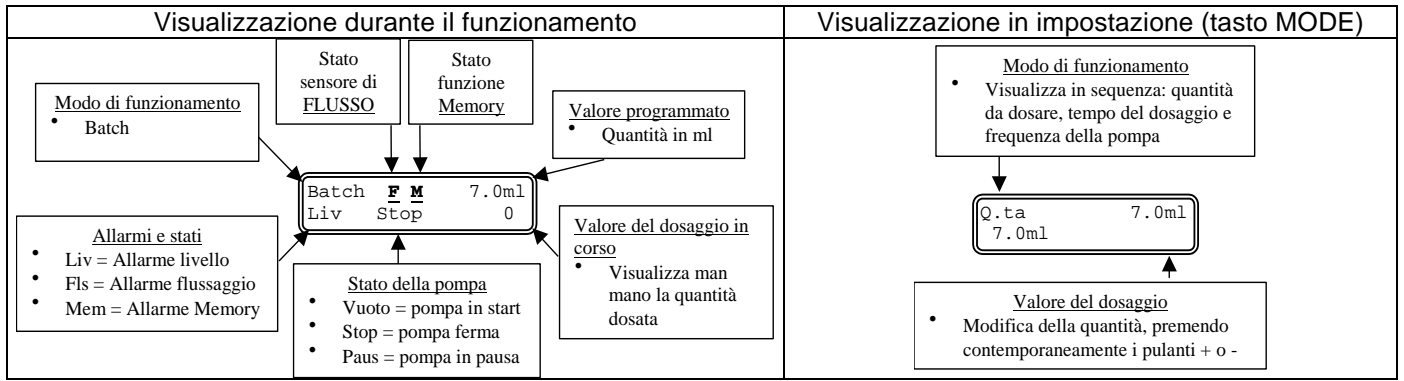



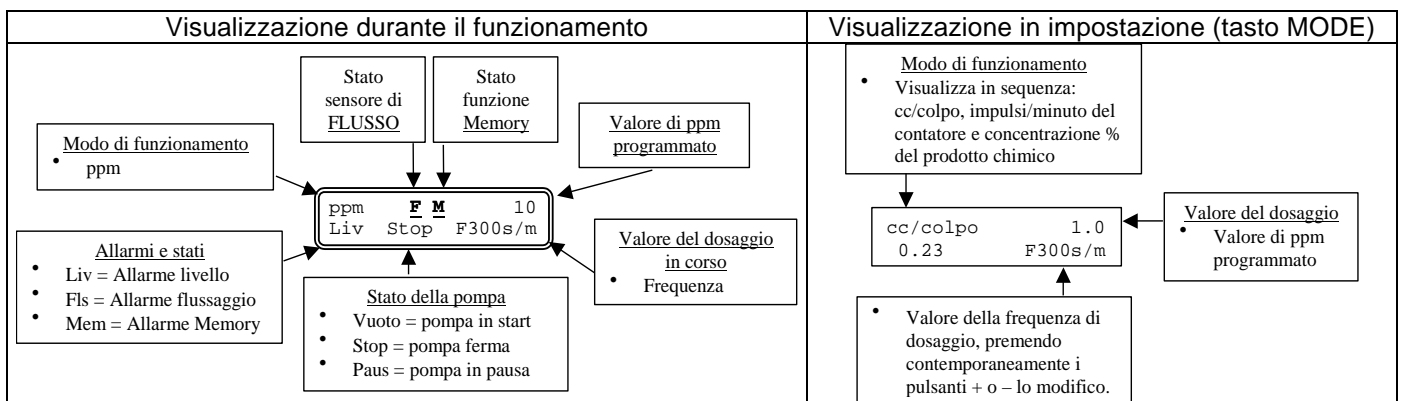
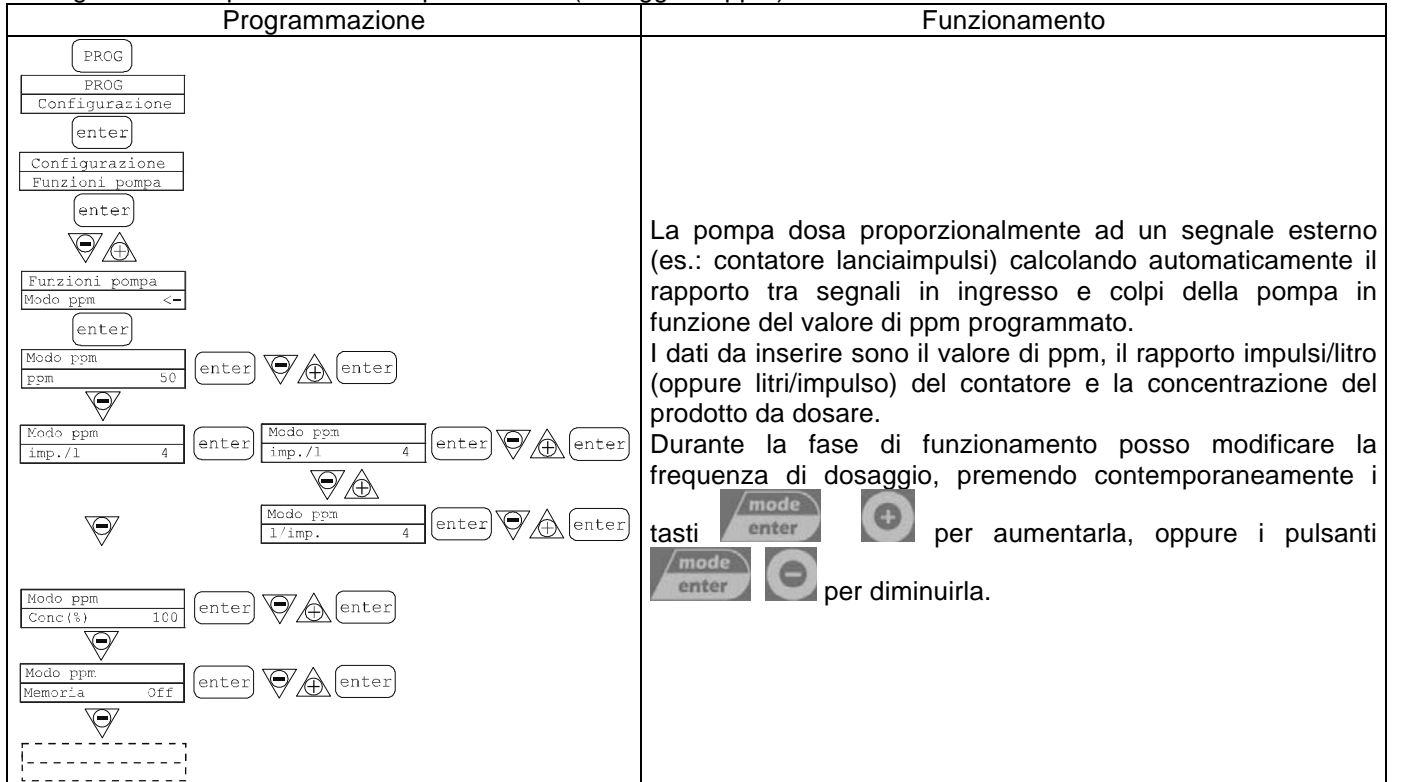

Paragrafo 7 – Proporzionale ad impulsi esterni (dosaggio in ppm)

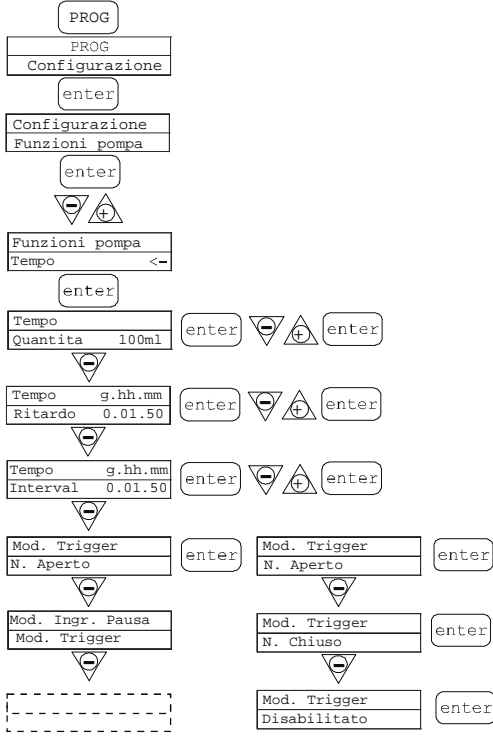
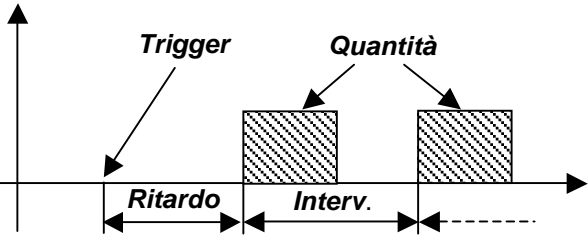
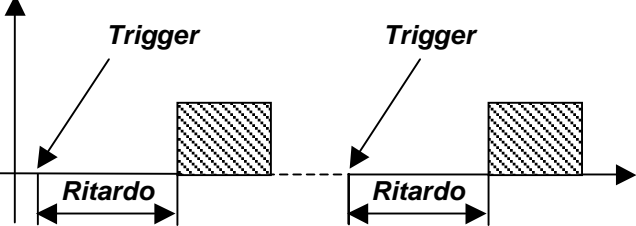



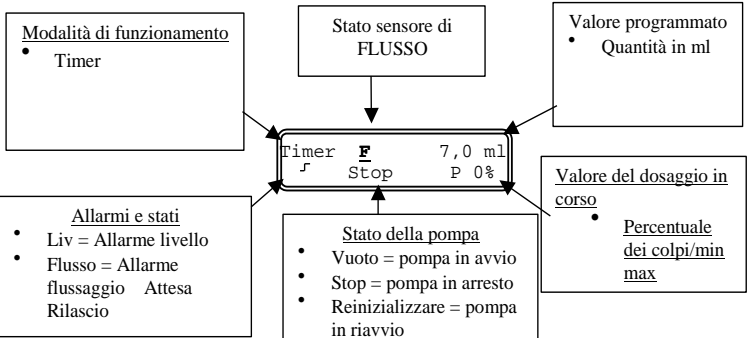
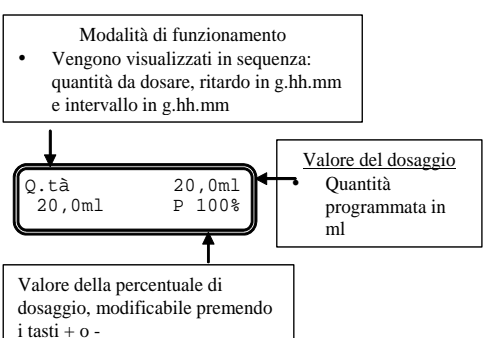

Paragrafo 8 – Dosaggio temporizzato (**Ingresso segnale frequenza “TRIGGER” attivato**)

Programmazione	Funzionamento
	<p>Dopo la ricezione del segnale di Trigger impostato, la pompa dosa una quantità programmabile in ml. È possibile impostare un tempo di ritardo prima del dosaggio (Ritardo) e la distanza tra dosaggi successivi (Interval.) come illustrato nello schema:</p>  <p>Impostando, ad esempio, un tempo Interval.= 0 si ottiene un sistema nel quale la quantità programmata viene dosata dopo ogni segnale di TRIGGER (con l'eventuale ritardo impostato):</p>  <p>È possibile avviare il dosaggio anche premendo il tasto +, il quale praticamente simula il segnale di Trigger. Il segnale Trigger può essere impostato su N. Aperto (si attiva quando l'ingresso passa dalla modalità aperta a quella chiusa) o su N. Chiuso (si attiva quando l'ingresso passa dalla modalità chiusa a quella aperta). Il segnale Trigger è bloccato durante il dosaggio (la sua ricezione non viene né memorizzata né gestita). L'ingresso Pausa (Ingresso telecomando) non può essere programmato e la sua attivazione blocca il dosaggio, mentre la successiva disattivazione rimette il sistema in attesa del segnale Trigger per un nuovo dosaggio.</p> <p>Durante la fase di funzionamento della pompa, è possibile modificare la frequenza di dosaggio premendo contemporaneamente i tasti   per aumentare la frequenza oppure i tasti   per diminuirla.</p>

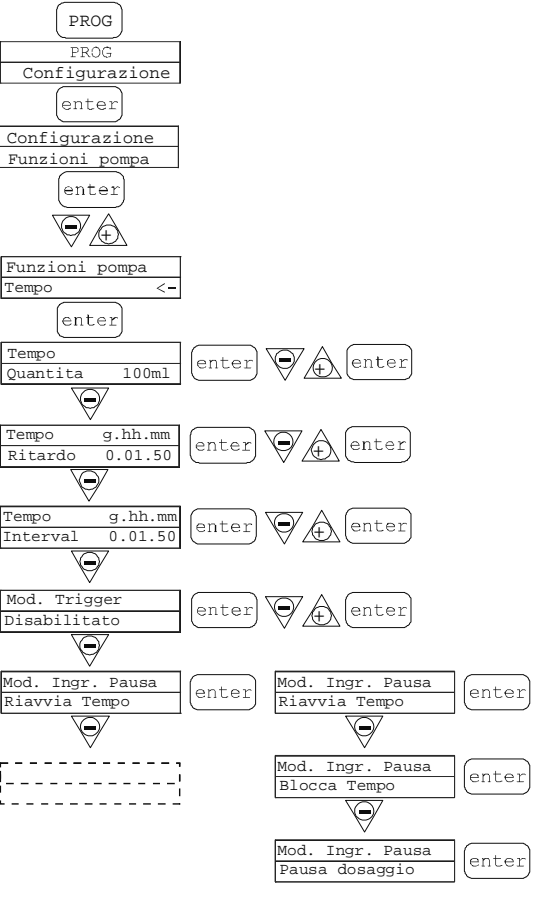
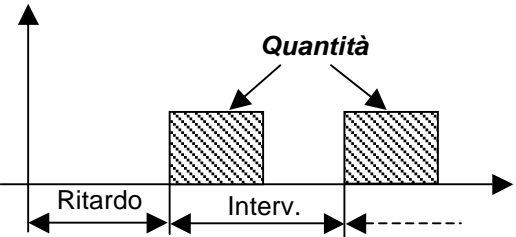

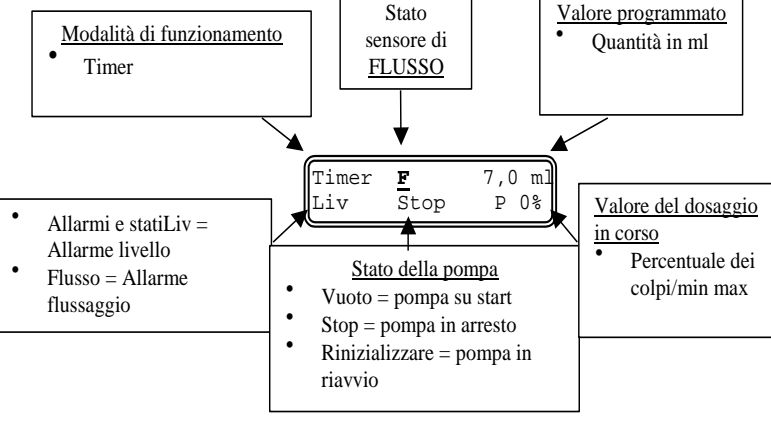
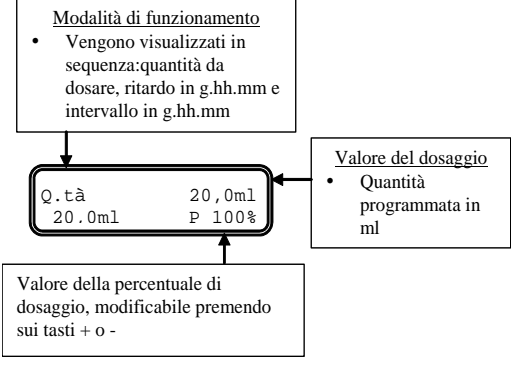

Visualizzazione durante il funzionamento	Visualizzazione all'avvio (tasto MODE)
	

Paragrafo 8 – Dosaggio temporizzato (**Ingresso segnale frequenza "TRIGGER" non attivato**)

Programmazione	Funzionamento
	<p>La pompa dosa una quantità programmabile in ml, è possibile impostare un tempo di ritardo all'avvio della pompa (Ritardo) e la distanza tra due dosaggi successivi (Interval.) come illustrato nello schema:</p>  <p>I tempi di Ritardo e di Interval. sono in gg.hh.mm (giorni.ore.minuti)</p> <p>L'ingresso della Pausa può essere programmato in tre modalità diverse:</p> <ol style="list-style-type: none"> 1. Blocca Tempo: con la pausa attivata, il sistema blocca il conteggio del tempo attuale e lo riprende quando la pausa si disattiva 2. Pausa dosaggio: con la pausa attivata, il sistema continua a contare il tempo e blocca il dosaggio 3. Riavvia Tempo: con la pausa attivata, il sistema blocca il dosaggio e quando la pausa si disattiva il conteggio ricomincia dall'inizio. <p>Durante la fase di funzionamento della pompa, è possibile modificare la frequenza di dosaggio premendo contemporaneamente i tasti   per aumentare la frequenza oppure i tasti   per diminuirla.</p>

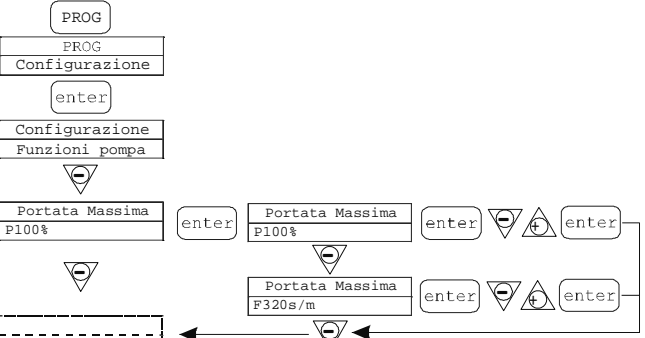
Visualizzazione durante il funzionamento	Visualizzazione all'avvio (tasto MODE)
	

Paragrafo 9 – Impostazione massima portata

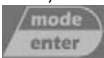
Programmazione	Funzionamento
	<p>Permette di impostare la massima portata raggiungibile dalla pompa e la modalità programmata (% o frequenza) diventa la visualizzazione della portata nell'unità di misura standard. Premendo  si accede alla modifica, quindi con i tasti   imposto il valore. Con  confermo e torno al menu principale</p>

Paragrafo 10 – Impostazione relé d'allarme

Programmazione	Funzionamento
	<p>In assenza di situazione d'allarme può essere impostato aperto (fabbrica) oppure chiuso.</p> <p>Premendo si accede alla modifica, quindi con i tasti imposto il valore. Con confermo e torno al menu principale</p>





Paragrafo 11 – Calibrazione portata

Programmazione	Funzionamento
	<p>Nel menu principale appare il valore di cc a colpo in memoria. È possibile calibrare in due modalità:</p> <p>MANUALE – inserisco manualmente il valore di cc a colpo con i tasti e confermo con </p> <p>AUTOMATICA – la pompa esegue 100 colpi, che vengono avviati con il tasto e confermo con , alla fine dei quali inserisco la quantità aspirata dalla pompa con i tasti e confermo con .</p> <p>Il dato inserito verrà utilizzato nei calcoli delle portate.</p>



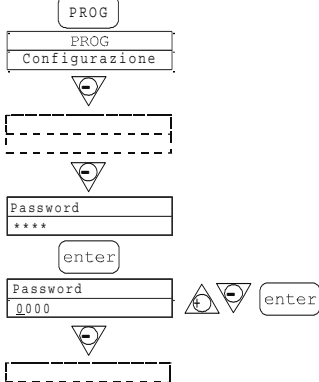







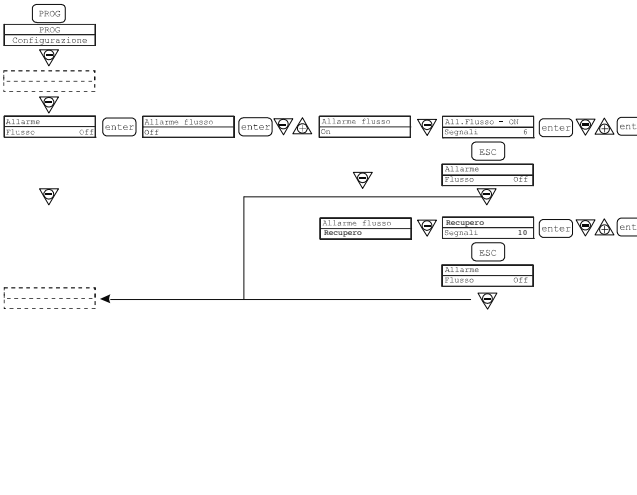

Paragrafo 12 – Statistiche

Programmazione	Funzionamento
	<p>Nel menu principale visualizza le ore di funzionamento della pompa, premendo il tasto accedo alle altre statistiche:</p> <ul style="list-style-type: none"> - Strokes = numero di colpi eseguito dalla pompa - Q.ty(L) = quantità dosata dalla pompa espressa in litri; questo dato viene calcolato in base al valore cc/stroke in memoria - Power = numero di avviamenti della pompa - Reset = i tasti decido se azzerare i contatori (YES) oppure no (NO), con confermo. <p>La pressione di permette di tornare al menu principale.</p>







Paragrafo 13 – Password

Programmazione	Funzionamento
	<p>Inserendo la password, potrò entrare in programmazione e vedere tutti i valori impostati, ma ogni volta che cercherò di modificarli verrà richiesta la password.</p> <p>La linea lampeggiante indica il numero modificabile, con il tasto  seleziono il numero (da 1 a 9), con il tasto  seleziono il numero da modificare, quindi con  confermo. Impostando “0000” (fabbrica), la password viene esclusa.</p>

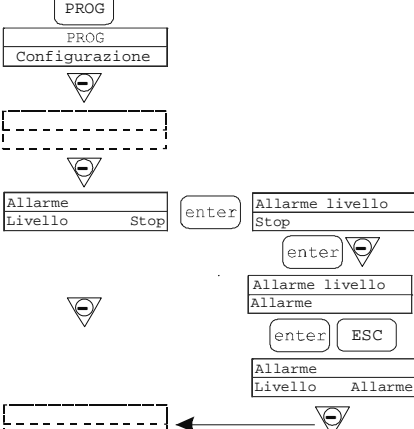
Paragrafo 14 – Allarme di flusso

Programmazione	Funzionamento
	<p>Permette di attivare (disattivare) il sensore di flusso.</p> <p>Una volta attivato (On) premendoli tasto  si accede alla richiesta di quanti segnali aspetta la pompa prima di andare in allarme. Premendo  lampeggia il numero, quindi con i tasti   imposto il valore. Con  confermo. Premendo  torno al menu principale.</p> <p>Solo in modalità Batch è possibile attivare la modalità Recupero. La pompa ripete il numero di colpi non rilevati dal sensore di flusso. Premendo il tasto  si accede alla richiesta del massimo numero di segnali che la pompa può recuperare prima di andare in allarme. Premendo  lampeggia il numero, quindi con i tasti   imposto il valore. Con  confermo. Premendo  torno al menu principale</p>

Paragrafo 15 – Allarme di livello

Programmazione	Funzionamento
	<p>Permette di impostare la pompa quando si attiva l'allarme del sensore di livello, cioè se bloccare il dosaggio (Stop), oppure se semplicemente attivare la segnalazione d'allarme senza bloccare il dosaggio.</p> <p>Premendo  si accede alla modifica, quindi con i tasti   imposto il tipo di allarme. Con  confermo.</p> <p>Premendo  torno al menu principale</p>

Paragrafo 16 – Unità visualizzazione portata

Programmazione	Funzionamento
	<p>Permette di impostare l'unità di misura del dosaggio a display in visualizzazione.</p> <p>Premendo si accede alla modifica, quindi con i tasti imposto il tipo di unità di misura, L/h (Litri/ora), Gph (Galloni/ora), ml/m (millilitri/minuto) o standard (% o frequenza, a seconda di come impostato). Con confermo e torno al menu principale</p>

Paragrafo 17 – Impostazione Pausa

Programmazione	Funzionamento
	<p>Ingresso remoto per mettere in pausa la pompa. In fabbrica il sistema è impostato come Normalmente Aperto.</p> <p>Premendo si accede alla modifica, quindi con i tasti imposto il valore (N. APERTO oppure N. CHIUSO)</p> <p>Con confermo e torno al menu principale.</p>

Regolazione contrasto display

Per la regolazione del contrasto del display tenere premuto il tasto e entro 5 secondi premere i tasti o per incrementare o meno il contrasto.

Allarmi

Visualizzazione	Causa	Interruzione				
Led Alarm fisso Scritta lev lampeggiante Es: <table border="1" style="display: inline-table; vertical-align: middle;"><tr><td>Man</td><td></td></tr><tr><td>Lev</td><td>P100%</td></tr></table>	Man		Lev	P100%	Allarme fine di livello, senza interruzione del funzionamento della pompa	Ripristino del livello del liquido.
Man						
Lev	P100%					
Led Alarm fisso Scritta lev e stop lampeggiante Es: <table border="1" style="display: inline-table; vertical-align: middle;"><tr><td>Man</td><td></td></tr><tr><td>Lev</td><td>Stop P100%</td></tr></table>	Man		Lev	Stop P100%	Allarme fine di livello, con interruzione del funzionamento della pompa	Ripristino del livello del liquido
Man						
Lev	Stop P100%					
Scritta Mem lampeggiante Es: <table border="1" style="display: inline-table; vertical-align: middle;"><tr><td>l:n</td><td>6</td></tr><tr><td>Mem</td><td></td></tr></table>	l:n	6	Mem		La pompa riceve uno o più impulsi durante il dosaggio con funzione memory in Off	Pressione del tasto
l:n	6					
Mem						
Scritta Mem lampeggiante Es: <table border="1" style="display: inline-table; vertical-align: middle;"><tr><td>l:n</td><td><u>M</u> 6</td></tr><tr><td>Mem</td><td></td></tr></table>	l:n	<u>M</u> 6	Mem		La pompa riceve uno o più impulsi durante il dosaggio con funzione memory in On	Quando la pompa finisce di ricevere gli impulsi esterni restituisce i colpi memorizzati
l:n	<u>M</u> 6					
Mem						
Led Alarm fisso Scritta Flw lampeggiante Es: <table border="1" style="display: inline-table; vertical-align: middle;"><tr><td>Man</td><td><u>F</u></td></tr><tr><td>Flw</td><td>P100%</td></tr></table>	Man	<u>F</u>	Flw	P100%	Allarme di flusso attivo, la pompa non ha ricevuto il numero di segnali programmati dal sensore di flusso.	Pressione del tasto
Man	<u>F</u>					
Flw	P100%					
Es: <table border="1" style="display: inline-table; vertical-align: middle;"><tr><td>Parameter Error</td></tr><tr><td>PROG to default</td></tr></table>	Parameter Error	PROG to default	Errore di comunicazione interna della CPU.	Pressione del tasto per ripristinare i parametri di default.		
Parameter Error						
PROG to default						





Painel de Controle - DOSATec LMS



	Acesso ao menu de programação
	Durante a fase de funcionamento da bomba: acionado visualiza ciclicamente no display os valores programados; Acionando simultaneamente às teclas aumenta ou reduz um valor dependente da modalidade de funcionamento pré-escolhida. Na programação desenvolve a função "enter", isto é, confirma a entrada nos vários níveis de menu e as modificações no interior dos mesmos.
	Liga ou desliga a bomba. Nas condições de alarme de nível (só função alarme), de fluxo e memory ativas, desativa a sinalização no display.
	Para "sair" dos vários níveis de menu. Antes de sair definitivamente da programação se acessa a requisição de salvar modificações.
	Percorre os menus para cima, ou ainda, aumenta os valores numéricos a modificar. Na modalidade Batch pode iniciar a dosagem.
	Percorre os menús para baixo, ou ainda, reduz os valores numéricos a modificar.
	Led verde lampejante durante a dosagem.
	Led vermelho que ascende nas varias situações de alarme.

Conexões Elétricas

	1	Relê de alarme		
	2			
	3	Polo +	Entrada 4-20 mA Impedância de entrada: 200 ohm	
	4	Polo -		
	5	-Entrada do controle remoto (start-stop)		
	6	-Entradas Pausa sinal		
	7	-Entradas de sinal em frequência (contador lança-impulsos)		
	8	-Entradas Trigger sinal		
	9	Entradas do sensor de fluxo		
	10			
B	Entrada da sonda de controle de nível			

Acionando a tecla  por mais de três segundos se acessa a programação. Com as teclas   é possível percorrer os itens do menu, com a tecla  se acessam as modificações. De fábrica a bomba vem programada na modalidade constante. A bomba volta automaticamente na modalidade de funcionamento depois de 1 minuto de inatividade. Neste caso dados eventualmente inseridos não serão salvos.

Com a tecla  se sai dos níveis da programação. Na saída da programação o display mostra:

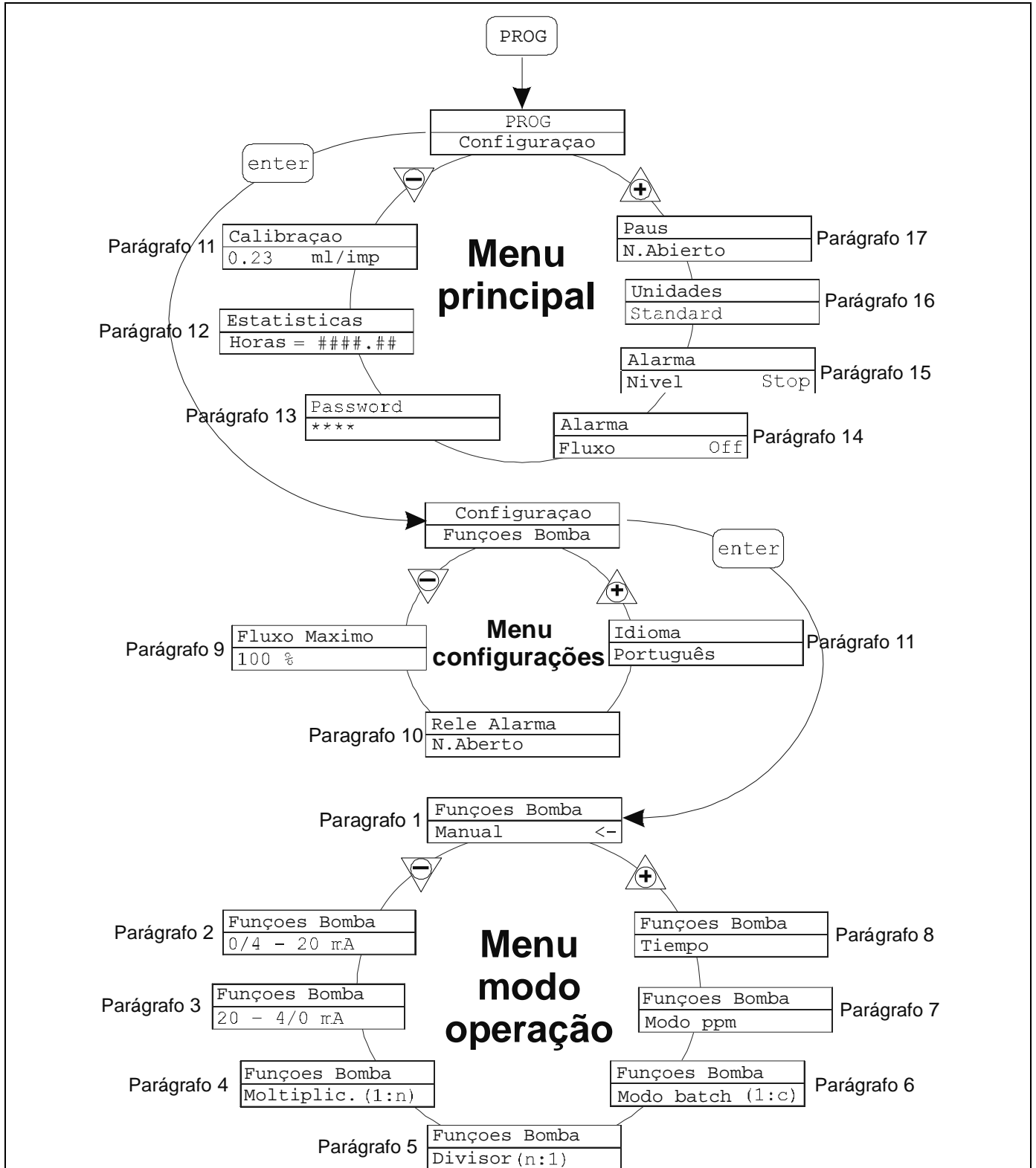
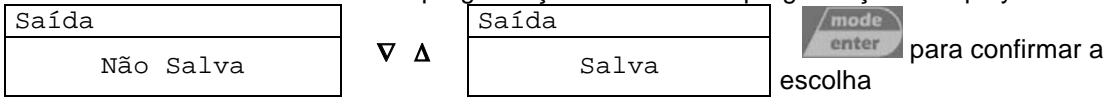

Seleção do Idioma

Programação	Funcionamento
<pre> graph TD A[PROG] --> B[PROG Configuração] B --> C[enter] C --> D[Configuração Funções Bomba] D --> E[Fluxo Maximo P100%] E --> F[Rele Alarma N.Abierto] F --> G[Idioma Portugêes] G --> H[enter] H --> I[] I --> J[enter] J --> K[] K --> L[] </pre>	<p>Permite selecionar o idioma, de fábrica a bomba vem programada em inglês.</p> <p>Acionando se acessa a modificação, a seguir, com as teclas seleciono o valor. Com confirmo e volto ao menu principal</p>

Parágrafo 1 - Dosagem Manual

Programação	Funcionamento
<pre> graph TD A[PROG] --> B[PROG Configuração] B --> C[enter] C --> D[Configuração Funções Bomba] D --> E[enter] E --> F[Funções Bomba Manual] F --> G[enter] </pre>	<p>A bomba trabalha na modalidade constante. A vazão é controlada e manualmente acionando simultaneamente as teclas para aumentar o valor da vazão, ou ainda as teclas para diminuí-lo.</p>

Visualização durante o funcionamento	Visualização em seleção (tecla MODE)
<p>Modo de funcionamento</p> <ul style="list-style-type: none"> Man = Manual <p>Estado sensor de FLUXO</p> <p>Estado da bomba</p> <ul style="list-style-type: none"> Vazio = bomba em start Stop = bomba parada Paus = bomba em pausa <p>Valor da dosagem em curso (depende da unidade de medida selecionada)</p> <ul style="list-style-type: none"> Porcentual, Frequência, l/h, Gph, ml/m <p>Alarmes e estados</p> <ul style="list-style-type: none"> Niv = Alarme nível Flx = Alarme fluxo 	<p>Modo de funcionamento</p> <ul style="list-style-type: none"> Visualiza o valor correspondente à frequência <p>Valor da dosagem em curso</p> <ul style="list-style-type: none"> Modificação da vazão máxima acionando simultaneamente as teclas + o -

Parágrafo 2 - Dosagem Proporcional a Sinal 0/4-20 mA

Programação	Funcionamento
	<p>A bomba dosa proporcionalmente a um sinal (0)4-20 mA. De fábrica a bomba interrompe a dosagem a 4 mA e dosa na máxima frequência selecionada quando recebe 20 mA. Em programação é possível modificar estes dois valores. A frequência máxima é modificável durante o funcionamento, acionando simultaneamente as teclas para aumentar a vazão, ou ainda, as teclas para diminuí-la.</p>

Visualização durante o funcionamento	Visualização em seleção (tecla MODE)

Parágrafo 3 - Dosagem Proporcional a Sinal 20-4/0 mA

Programação	Funcionamento
	<p>A bomba dosa proporcionalmente a um sinal 20-4(0) mA. De fábrica a bomba interrompe a dosagem a 20 mA e dosa na máxima frequência selecionada quando recebe 4 mA. Em programação é possível modificar estes dois valores. A frequência máxima é modificável durante a fase de funcionamento acionando simultaneamente as teclas para aumentar a vazão, ou ainda, as teclas para diminuí-la.</p>

Visualização durante o funcionamento	Visualização em seleção (tecla MODE)

Parágrafo 4 - Proporcional a impulsos externos (multiplicação)

Programação	Funcionamento
<p>The diagram shows the programming sequence for proportional dosing by multiplication. It starts with 'PROG', followed by 'Configuração', then 'Funções Bomba'. The user selects 'Multiplic. (1:n)', enters the value '4', then 'T.Maximo 0s', and finally 'Memoria Off'.</p>	<p>A bomba dosa proporcionalmente a um sinal externo (ex.: contador lança impulsos). A cada sinal recebido a bomba efetua os “n” golpes programados. A bomba seleciona automaticamente a frequência de dosagem, adaptando-a ao tempo que intercorre entre dois sinais sucessivos. É possível programar em segundos ou tempo (time/out) além do qual a bomba zera a contagem do intervalo, para evitar dosagens em tempos muito longos. A bomba dispõe da função memory, que assinala o recebimento de um sinal durante a dosagem. Se selecionada em Off se limita a assinalar, se em On assinala e memoriza os impulsos, a seguir os executa quando para de receber sinais. O valor de “n” é modificável durante a fase de funcionamento acionando simultaneamente as teclas para aumentar o valor da vazão, ou ainda, as teclas para reduzi-lo.</p>









Visualização durante o funcionamento	Visualização em seleção (tecla MODE)
<p>The diagram shows the display during operation for the multiplication mode. The display shows '1:n', 'Niv', 'Stop', and '1'. It also shows 'F M' and '0'. The 'Estado da bomba' section indicates 'Vazio = bomba em start', 'Stop = bomba parada', and 'Paus = bomba em pausa'. The 'Alarmes e estados' section lists 'Niv = Alarme Nível', 'Flx = Alarme fluxo', and 'Mem = Alarme Memory'.</p>	<p>The diagram shows the display in selection mode (tecla MODE). The display shows 'Tempo max 0s' and 'n 1'. The 'Valor da dosagem em curso' section indicates 'Mostra o count-down dos golpes'.</p>

Parágrafo 5 - Proporcional a impulsos externos (divisão)

Programação	Funcionamento
<p>The diagram shows the programming sequence for proportional dosing by division. It starts with 'PROG', followed by 'Configuração', then 'Funções Bomba'. The user selects 'Divisor (n:1)', enters the value '4', and then 'n'.</p>	<p>A bomba dosa proporcionalmente a um sinal externo (ex.: contador lança impulsos). A cada “n” sinais recebidos a bomba efetua um golpe. Em programação seleciono o valor de “n”. Programando o valor de “n” se seleciona a % de dosagem máxima, durante a fase de funcionamento posso modificar este valor acionando simultaneamente as teclas para aumentá-lo, ou ainda as teclas para diminuí-lo.</p>





Visualização durante o funcionamento	Visualização em seleção (tecla MODE)
<p>The diagram shows the display during operation for the division mode. The display shows 'n:1', 'Niv', 'Stop', and 'P100%'. It also shows '4'. The 'Estado da bomba' section indicates 'Vazio = bomba em start', 'Stop = bomba parada', and 'Paus = bomba em pausa'. The 'Alarmes e estados' section lists 'Niv = Alarme Nível' and 'Flx = Alarme fluxo'.</p>	<p>The diagram shows the display in selection mode (tecla MODE). The display shows 'n:1 6' and 'P100%'. The 'Valor da dosagem em curso' section indicates 'Modificação da % de dosagem acionando simultaneamente as teclas + ou -'.</p>

Parágrafo 6 - Proporcional a impulsos externos (dosagem batch)

Programação	Funcionamento
<pre> graph TD A[PROG] --> B[Configuração] B --> C[Funções Bomba] C --> D[Modo Batch (1:c) 10.0ml] D --> E[Modo Batch (1:c) T.Maximo 10s] E --> F[Modo Batch (1:c) Memoria Off] </pre>	<p>A bomba dosa proporcionalmente a um sinal externo (ex.: contador lança-impulsos). Neste caso posso programar a quantidade a dosar em ml e o tempo no qual completar a dosagem. É possível fazer a dosagem manualmente através da pressão da tecla , ou ainda, através de um comando remoto. A tecla , interrompe a dosagem, que pode ser zerada acionando a tecla , ou ainda, reiniciada acionando novamente .</p> <p>A quantidade a dosar é modificável durante a fase de funcionamento acionando simultaneamente as teclas   para aumentar a vazão, ou ainda, as teclas   para diminuí-la.</p>

Visualização durante o funcionamento	Visualização em seleção (tecla MODE)

Parágrafo 7 - Proporcional a impulsos externos (dosagem em PPM)

Programação	Funcionamento
<pre> graph TD A[PROG] --> B[Configuração] B --> C[Funções Bomba] C --> D[Modo ppm 50] D --> E[Modo ppm Pulsos/L 4] E --> F[Modo ppm Conc(%) 100] F --> G[Modo ppm Memoria off] </pre>	<p>A bomba dosa proporcionalmente a um sinal externo (ex.: contador lança-impulsos) calculando automaticamente a relação entre sinais em entrada e golpes da bomba em função do valor de ppm programado. Os dados a inserir são o valor de ppm, a relação impulsos/litro (ou ainda litros/impulso) do contador e a concentração do produto a dosar. Durante a fase de funcionamento posso modificar a frequência de dosagem, acionando simultaneamente as teclas   para aumentá-la, ou ainda as teclas   para diminuí-la.</p>

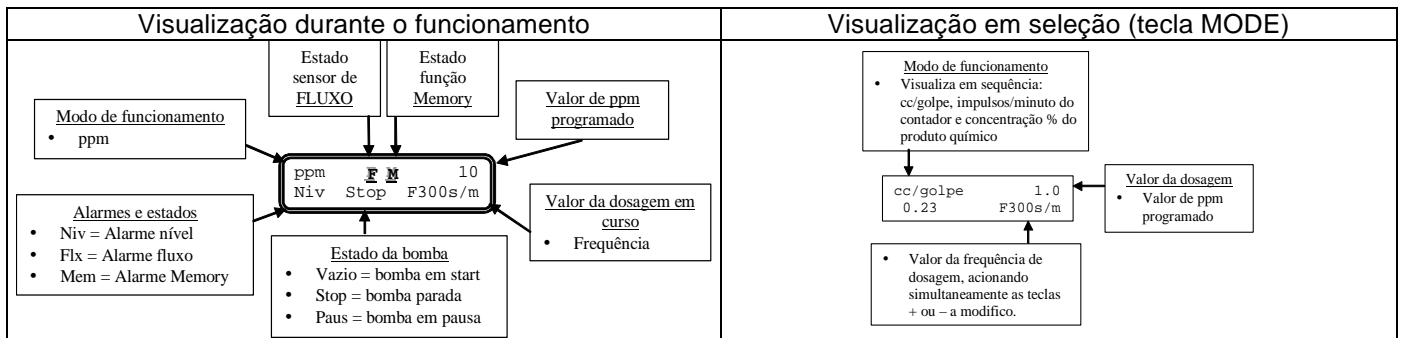

Parágrafo 8 – Dosagem temporizada (Entrada do sinal de frequência “TRIGGER” activado)

Programação	Funcionamento
<pre> PROG Configuração enter Configuração Funções Bomba enter Funções Bomba Tiempo <- enter Tiempo Quantidade 100ml Retardo 0.01.50 Interval 0.01.50 Modo Trigger N. Abierto Mod. Ingr. Pausa Modo Trigger N. Cerrado Modo Trigger Desabilitado </pre>	<p>Após a recepção do sinal de TRIGGER iniciado, a bomba doseia uma quantidade programável em ml. É possível estabelecer um tempo de atraso antes da dosagem (Atraso) e a distância entre as dosagens seguintes (Interv.) conforme ilustrado no esquema</p> <p>Ajustando, por exemplo, um tempo Interv.= 0 obtém-se um sistema no qual a quantidade programada é doseada depois de cada sinal de TRIGGER (com o eventual atraso iniciado):</p> <p>É possível iniciar a dosagem também premindo o botão +, o qual praticamente simula o sinal de Trigger. O sinal Trigger pode ser iniciado em N.Abierto (activa-se quando a entrada passa da modalidade aberta para fechada) ou em N.Cerrado (activa-se quando a entrada passa da modalidade fechada para aberta). O sinal Trigger fica bloqueado durante a dosagem (a sua recepção não se encontra memorizada nem gerida) A entrada Pausa (Entrada telecomando) não pode ser programada e a sua activação bloqueia a dosagem, enquanto a desactivação seguinte remete o sistema em espera do sinal Trigger para uma nova dosagem.</p> <p>Durante a fase de funcionamento da bomba, poderá alterar a frequência de dosagem, ao premir simultaneamente as teclas</p> <div style="display: flex; align-items: center; gap: 10px;"> <div style="border: 1px solid black; padding: 2px;">mode</div> <div style="border: 1px solid black; padding: 2px;">enter</div> <div style="border: 1px solid black; padding: 2px;">+</div> </div> <p>para aumentar a frequência, ou também os botões</p> <div style="display: flex; align-items: center; gap: 10px;"> <div style="border: 1px solid black; padding: 2px;">mode</div> <div style="border: 1px solid black; padding: 2px;">enter</div> <div style="border: 1px solid black; padding: 2px;">-</div> </div> <p>para a diminuir.</p>

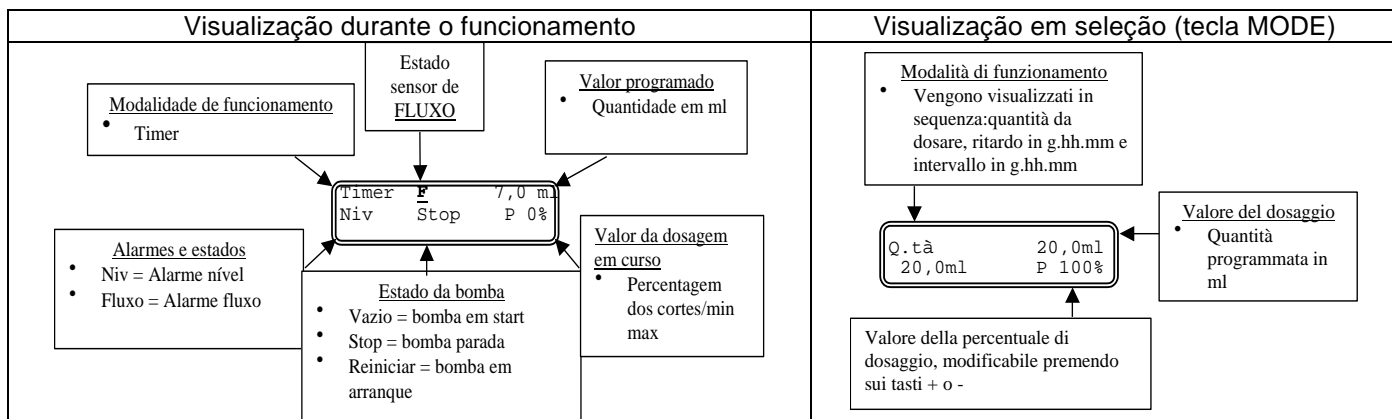

Parágrafo 8 – Dosagem temporizada (Entrada do sinal de frequência “TRIGGER” não activado)

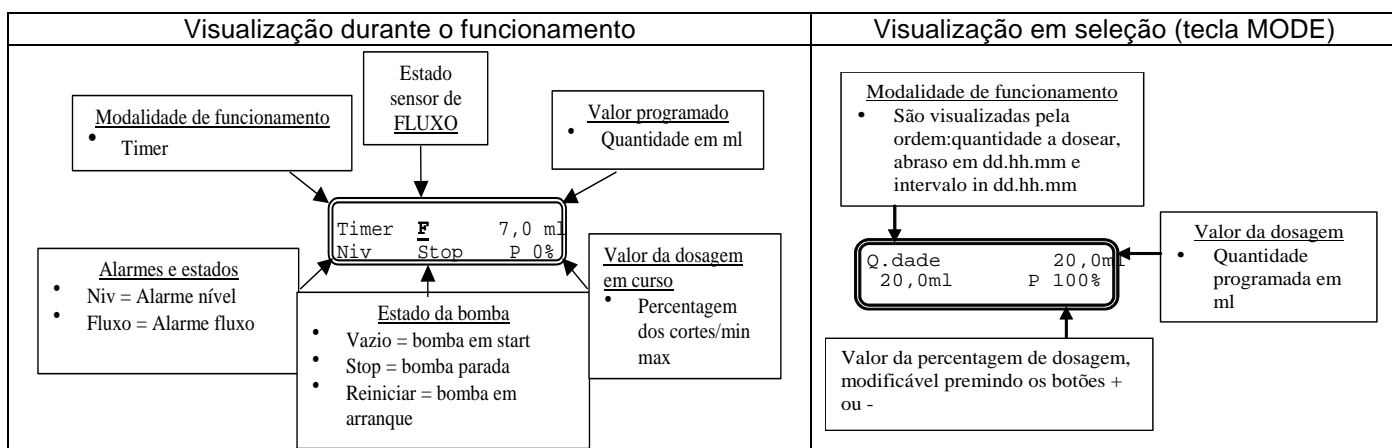
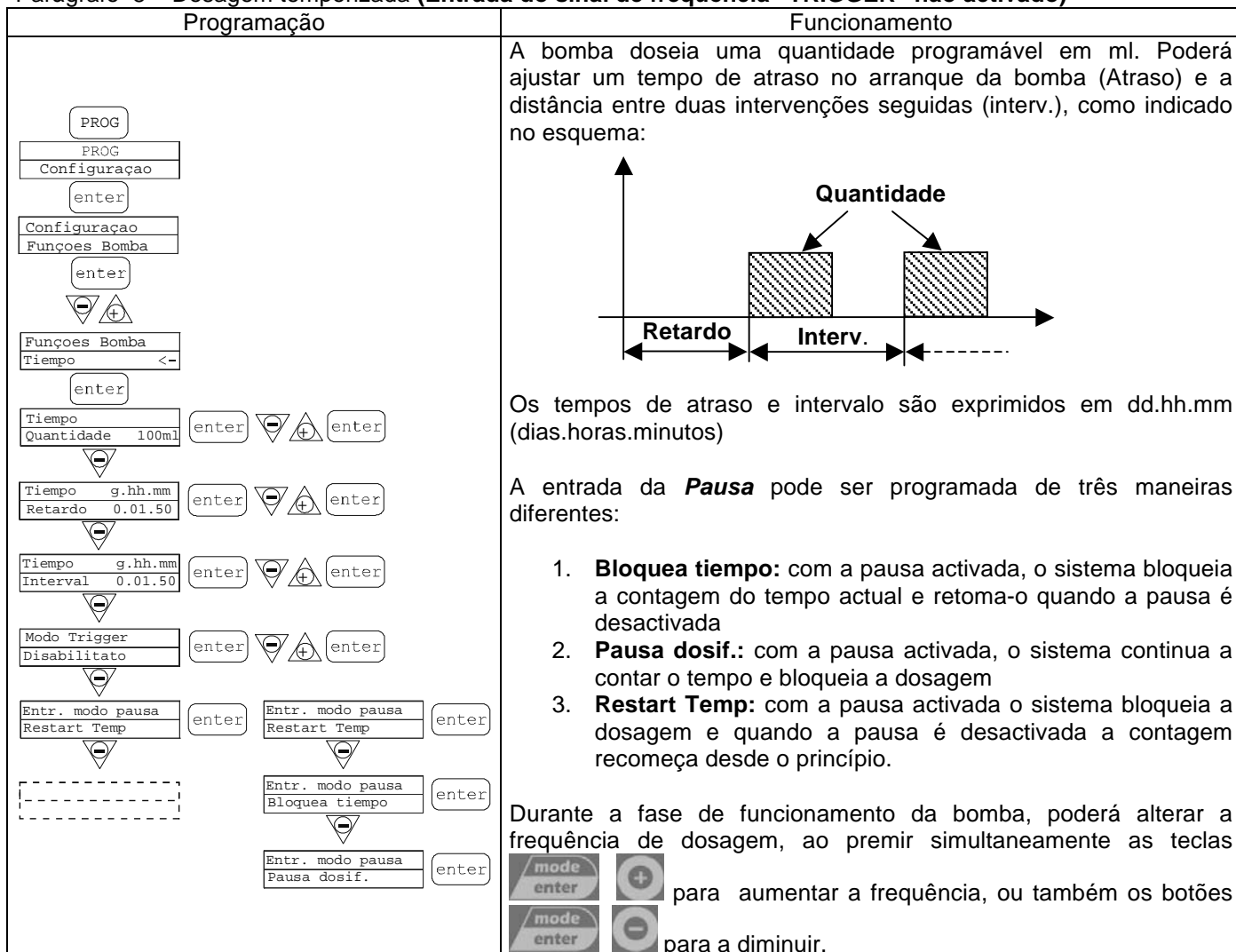

Parágrafo 9 - seleção máxima vazão

Programação	Funcionamento
	<p>Permite selecionar a máxima vazão alcançável pela bomba e a modalidade programada (% ou frequência) fica a visualização da vazão na unidade de medida Standard.</p> <p>Acionando se acessa a modificação, e a seguir com as teclas seleciono o valor. Com confirmo e volto ao menu principal</p>

Parágrafo 10 - Seleção do Relê de Alarme

Programação	Funcionamento
	<p>Na ausência de situação de alarme pode ser selecionado aberto (de fábrica) ou ainda, fechado.</p> <p>Acionando se acessa a modificação, a seguir com as teclas seleciono o valor. Com confirmo e volto ao menu principal</p>

Parágrafo 11 – Calibração da vazão

Programação	Funcionamento
	<p>No menu principal aparece o valor de cc por golpe em memória. É possível calibrar em duas modalidades:</p> <p>MANUAL - insiro manualmente o valor de cc por golpe com as teclas e confirmo com </p> <p>AUTOMÁTICA - a bomba executa 100 golpes, que são iniciados com a tecla e confirmo com , no final dos quais insiro a quantidade aspirada pela bomba com as teclas e confirmo com .</p> <p>O dado inserido será utilizado nos cálculos das vazões.</p>

Parágrafo 12 - Estatísticas

Programação	Funcionamento
	<p>No menu principal visualiza as horas de funcionamento da bomba, acionando a tecla acesso as outras estatísticas:</p> <ul style="list-style-type: none"> - Strokes = número de golpes executados pela bomba - Q.ty(L) = quantidade dosada pela bomba expressa em litros; este dado é calculado com base no valor cc/stroke na memória - Power = número de acionamentos da bomba <p>Reset = as teclas decido se zerar os contadores (YES) ou ainda não (NO), com confirmo.</p> <p>A pressão de permite voltar ao menú principal.</p>



Parágrafo 13 - Senha

Programação	Funcionamento
	<p>Inserindo a senha, poderei entrar em programação e ver todos os valores selecionados, mas cada vez que tentar modifica-los será pedida a senha.</p> <p>A linha lampejante indica o número modificável, com a tecla seleciono o número (de 1 a 9), com a tecla seleciono o número a modificar, a seguir com confirmo. Selecionando "0000" (fábrica), a senha será excluída.</p>

Parágrafo 14 - Alarme de Fluxo

Programação	Funcionamento
	<p>Permite ativar (desativar) o sensor de fluxo.</p> <p>Uma vez ativado (On) acionando a tecla se acessa a requisição de quantos sinais a bomba espera antes de entrar em alarme. Acionando lampeja o número, a seguir, com as teclas seleciona-se o valor desejado. Com confirmo. Acionando volto ao menu principal.</p> <p>Somente a partir do modo Batch é possível ativar o modo Recuperação. A bomba repete o número de impulsos não detectados pelo sensor de fluxo. Através do pressionamento da tecla acede-se à solicitação do número máximo de sinais que a bomba pode recuperar antes de entrar em estado de alarme. Após o pressionamento da tecla o número é exibido de forma intermitente e é necessário definir o valor utilizando as teclas . Através da tecla é possível confirmar. Pressionando retorna-se ao menu principal.</p>

Alarmes

Visualização	Causa	Interrupção						
Led Alarme fixo Escrita lev lampejante Ex: <table border="1" style="display: inline-table; vertical-align: middle;"> <tr> <td>Man</td> <td></td> <td></td> </tr> <tr> <td>Lev</td> <td></td> <td>P100%</td> </tr> </table>	Man			Lev		P100%	Alarme de fim de nível, sem interrupção do funcionamento da bomba	Restauração do nível do líquido.
Man								
Lev		P100%						
Led Alarme fixo Escrita lev e stop lampejante Ex: <table border="1" style="display: inline-table; vertical-align: middle;"> <tr> <td>Man</td> <td></td> <td></td> </tr> <tr> <td>Lev</td> <td>Stop</td> <td>P100%</td> </tr> </table>	Man			Lev	Stop	P100%	Alarme de fim de nível, com interrupção de funcionamento da bomba	Restauração do nível do líquido
Man								
Lev	Stop	P100%						
Escrita Mem lampejante Ex: <table border="1" style="display: inline-table; vertical-align: middle;"> <tr> <td>1:n</td> <td></td> <td>6</td> </tr> <tr> <td>Mem</td> <td></td> <td></td> </tr> </table>	1:n		6	Mem			A bomba recebe um ou mais impulsos durante a dosagem com função memory em Off	Pressionar a tecla 
1:n		6						
Mem								
Escrita Mem lampejante Ex: <table border="1" style="display: inline-table; vertical-align: middle;"> <tr> <td>1:n</td> <td><u>M</u></td> <td>6</td> </tr> <tr> <td>Mem</td> <td></td> <td></td> </tr> </table>	1:n	<u>M</u>	6	Mem			A bomba recebe um ou mais impulsos durante a dosagem com função memory em On	Quando a bomba acaba de receber os impulsos externos devolve os golpes memorizados
1:n	<u>M</u>	6						
Mem								
Led Alarme fixo Escrita Flw lampejante Ex: <table border="1" style="display: inline-table; vertical-align: middle;"> <tr> <td>Man</td> <td><u>F</u></td> <td></td> </tr> <tr> <td>Flw</td> <td></td> <td>P100%</td> </tr> </table>	Man	<u>F</u>		Flw		P100%	Alarme de fluxo ativo, a bomba não recebeu o número de sinais programados pelo sensor de fluxo.	Pressionar a tecla 
Man	<u>F</u>							
Flw		P100%						
Ex: <table border="1" style="display: inline-table; vertical-align: middle;"> <tr> <td>Parameter Error</td> <td></td> </tr> <tr> <td>PROG to default</td> <td></td> </tr> </table>	Parameter Error		PROG to default		Erro de comunicação interna da CPU.	Pressionar a tecla  para restaurar os parâmetros de default.		
Parameter Error								
PROG to default								

Kumanda Paneli – DOSA Tec LMS

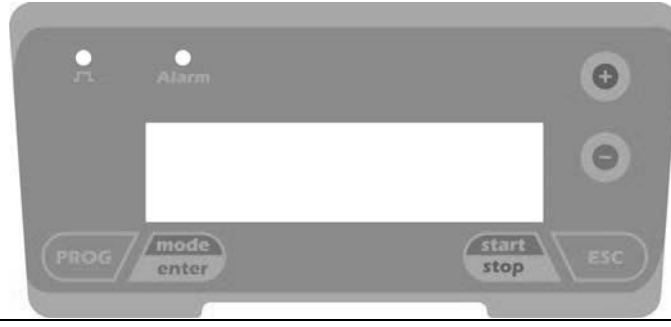

	Programlama menüsüne erişim
	Pompa çalışırken basıldığında, programlanan değerleri ekranda sırayla gösterir; veya tuşlarıyla aynı anda basıldığında, seçilen çalışma moduna bağlı olarak bir değeri artırır veya azaltır. Programlama sırasında bir "Enter" tuşu işlevi görerek çeşitli menü düzeylerine girişi ve bu düzeylerdeki değişiklikleri onaylar.
	Pompayı çalıştırır ve durdurur. Bir düzey alarmı (yalnızca alarm işlevi), debi alarmı ve etkin bellek alarmı meydana gelmesi durumunda, ekrandaki sinyali devre dışı bırakır.
	Çeşitli menü düzeylerinden "çıkılmak" için kullanılır. Programlama aşamasından tamamen çıkmadan önce değişiklikleri kaydetmek isteyip istemediğiniz sorulur.
	Menüde yukarı doğru hareket etmek veya değiştirilecek sayısal değerleri artırmak için kullanılır. Batch (Toplu işletim) modunda dozajlamayı başlatmak için kullanılabilir
	Menüde aşağı doğru hareket etmek veya değiştirilecek sayısal değerleri azaltmak için kullanılır.
	Dozajlama sırasında yeşil LED yanıp söner
	Çeşitli alarm durumlarında yanan kırmızı LED

Elektrik bağlantıları

	1	Alarm rölesi	
	2		
	3	+ kutbu	4-20 mA giriş sinyali Giriş Empedansı: 200 ohm
	4	- kutbu	
	5	-Uzaktan kumanda girişi (çalıştır-durdur)	
	6	-Giriş Sinyal Duraklat	
	7	-Frekans sinyali girişi (su sayacı darbe göndericisi)	
	8	-Harici tetikl girişi	
	9	Debi sensörü girişi	
	10		
B	Giriş düzeyi kontrolü		



tuşuna üç saniye kadar basarak programlama menüsüne erişebilirsiniz. Menü içinde gezinmek için



tuşları, değişikliklere erişmek için



tuşu kullanılabilir.

Pompa fabrikada sabit modda programlanmıştır. Pompa, 1 dakika herhangi bir işlem yapılmazsa otomatik olarak çalışma moduna döner. Bu durumda girilen veriler kaydedilmez.



tuşu çeşitli programlama düzeylerinden çıkmak için kullanılabilir. Programlamadan çıkıldıktan sonra, şu ekran görüntülendir:

Exit (Çık)
Don't Save



Exit (Çık)
Save (Kaydet)



to confirm the selection
(seçimi onaylamak için)

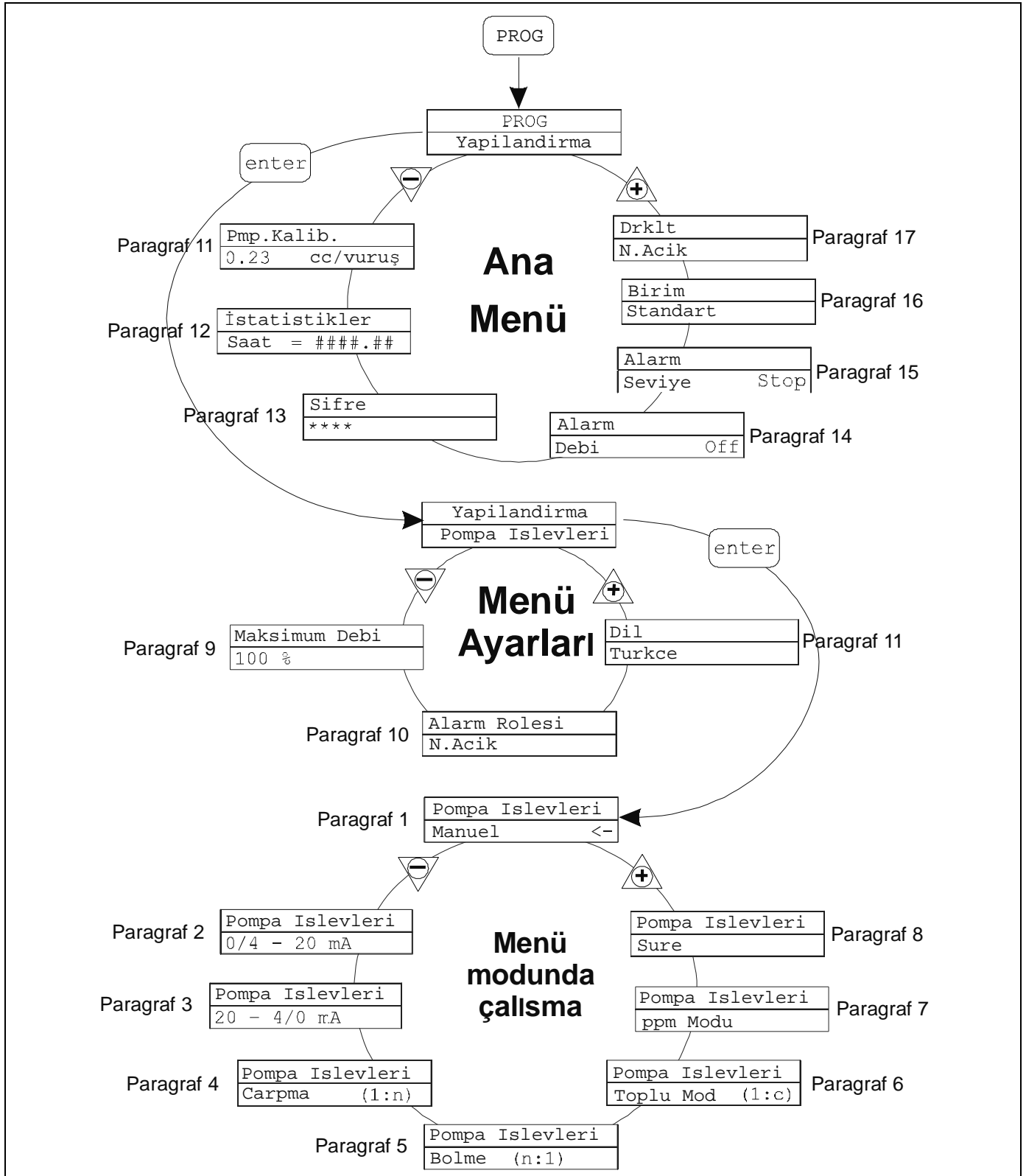

Dili Ayarlama

Programlama	İşlem
	<p>Dili seçmenize olanak sağlar. Pompa menü dili fabrikada İngilizce'ye ayarlanmıştır.</p> <p> tuşuna basıp ardından yeni değeri girmek için tuşlarına basılarak değişiklik yapılabilir. Onaylamak ve ana menüye dönmek için tuşuna basın</p>

Paragraf 1 – Manual Dosage (Manuel Dozajlama)

Programlama	İşlem
	<p>Pompa, sabit modda çalışır. Debi, tuşlarına aynı anda basıp artırılarak veya tuşlarına basıp azaltılarak yalnızca manuel olarak ayarlanabilir.</p>

Operation (Çalışma) sırasındaki ekran	Setting (Ayarlama) sırasındaki ekran (MODE tuşu)

Paragraf 2 - Dosage Proportional to Signal 0/4-20 (0/4-20 Sinyaline Orantılı Dozajlama)

Programlama	İşlem
	<p>Pompa (0)4-20 mA arasında bir sinyalde orantılı olarak dozajlama gerçekleştirir. Fabrika ayarlarına bağlı olarak, pompa dozajlamayı 4 mA sinyalinde durdurur ve 20 mA sinyal aldığıında ayarlanan maksimum frekansla dozajlama gerçekleştirir. Bu iki değer, programlama sırasında değiştirilebilir. Maksimum frekans, tuşlarına aynı anda basıp artırılarak veya tuşlarına basıp azaltılarak pompa çalışırken değiştirilebilir.</p>

Operation (Çalışma) sırasındaki ekran	Setting (Ayarlama) sırasındaki ekran (MODE tuşu)

Paragraf 3 - Dosage Proportional to Signal 20-4/0 (20-4/0 Sinyaline Orantılı Dozajlama)

Programlama	İşlem
	<p>Pompa 20-4(0) mA arasında bir sinyalde orantılı olarak dozajlama gerçekleştirir. Fabrika ayarlarına bağlı olarak, pompa dozajlamayı 20 mA sinyalinde durdurur ve 4 mA sinyal aldığıında ayarlanan maksimum frekansla dozajlama gerçekleştirir. Bu iki değer, programlama sırasında değiştirilebilir. Maksimum frekans, tuşlarına aynı anda basıp artırılarak veya tuşlarına basıp azaltılarak pompa çalışırken değiştirilebilir.</p>

Operation (Çalışma) sırasındaki ekran	Setting (Ayarlama) sırasındaki ekran (MODE tuşu)

Paragraf 4 – Proportional to External Impulses (Harici Darbelere Orantılı) (çarpanlı)

Programlama	İşlem
	<p>Pompa, harici bir sinyale (örn. sinyal darbe sayacı) orantılı olarak dozajlama gerçekleştirir. Pompa, alınan her sinyalde programlanan “n” sayıda vuruş gerçekleştirir. Pompa, dozajlama frekansını ard arda iki sinyal arasında geçen süreye uyarlayarak otomatik olarak ayarlar. Süre (zaman aşımı) saniye cinsinden ayarlanabilir; bu, dozajlamanın çok uzun süreler boyunca yapılmasını önlemek için pompanın belirlenen değer aşıldıktan sonra ara süre sayacını sıfırladığı süredir. Pompa, dozajlama sırasında sinyal alımını gösteren bir bellek işlevine sahiptir. Off (Kapalı) olarak ayarlanırsa, yalnızca bir sinyal gönderir; On (Açık) olarak ayarlanırsa, bir sinyal gönderip darbeleri hafızaya alır ve sinyal alımı bittiğinde bu darbeleri yürütür.</p> <p>“n” değeri, tuşlarına aynı anda basıp artırılarak veya tuşlarına basıp azaltılarak pompa çalışırken değiştirilebilir.</p>

Operation (Çalışma) sırasındaki ekran	Setting (Ayarlama) sırasındaki ekran (MODE tuşu)

Paragraf 5 – Proportional to External Impulses (division)

Programlama	İşlem
	<p>Pompa, harici bir sinyale (örn. sinyal darbe sayacı) orantılı olarak dozajlama gerçekleştirir. Her “n” sinyalde, pompa bir vuruş gerçekleştirir. Programlama sırasında “n” değerini ayarlayabilirsiniz. “n” değerini programlayarak maksimum dozaj %'ni ayarlıyorsunuz. Bu değer, tuşlarına aynı anda basıp debi artırılarak veya tuşlarına basıp debi azaltılarak pompa çalışırken değiştirilebilir.</p>

Operation (Çalışma) sırasındaki ekran	Setting (Ayarlama) sırasındaki ekran (MODE tuşu)

Paragraf 6 – Proportional to External Impulses (Harici Darbelere Orantılı) (toplu dozajlama)

Programlama	İşlem
	<p>Pompa, harici bir sinyale (örn. sinyal darbe sayacı) orantılı olarak dozajlama gerçekleştirir. Bu durumda, ml cinsinden dozajlanacak miktar ve dozajlamanın tamamlanacağı süre ayarlanabilir.</p> <p>Dozajlama tuşuna basılarak veya bir uzaktan kumanda sinyali kullanılarak manuel olarak başlatılabilir. tuşu dozajlamayı duraklatır, daha sonra tuşuna basılarak dozajlama sıfırlanabilir veya tuşuna yeniden basılarak tekrar başlatılabilir.</p> <p>Dozajlanacak miktar, tuşlarına aynı anda basıp debi artırılarak veya tuşlarına basıp debi azaltılarak pompa çalışırken değiştirilebilir.</p>

Operation (Çalışma) sırasındaki ekran	Setting (Ayarlama) sırasındaki ekran (MODE tuşu)

Paragraf 7 – Proportional to External Impulses (Harici Darbelere Orantılı) (ppm dozajlama)

Programlama	İşlem
	<p>Pompa, harici bir sinyale (örn. darbe başlatma sayacı) orantılı olarak dozajlama gerçekleştirir; bunu, programlanan ppm değerini esas alarak gelen sinyaller ile pompa vuruşları arasındaki ilişkiyi otomatik olarak hesaplayarak yapar. Girilmesi gereken değerler ppm değeri, sayacın darbe/litre oranı (veya litre/darbe) ve dozajlanacak ürünün yoğunluğudur.</p> <p>Dozajlama frekansı, tuşlarına aynı anda basıp artırılarak veya tuşlarına basıp debi azaltılarak pompa çalışırken değiştirilebilir.</p>

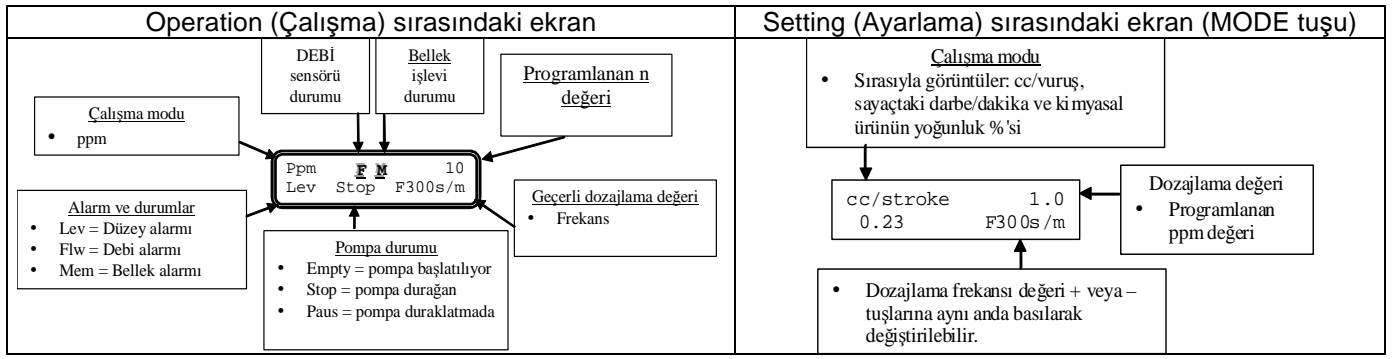

Paragraph 8 – Timed Dosage (Zamanlanmış Dozajlama) (“**TETİK**” aktif hale getirilmiş durumda)

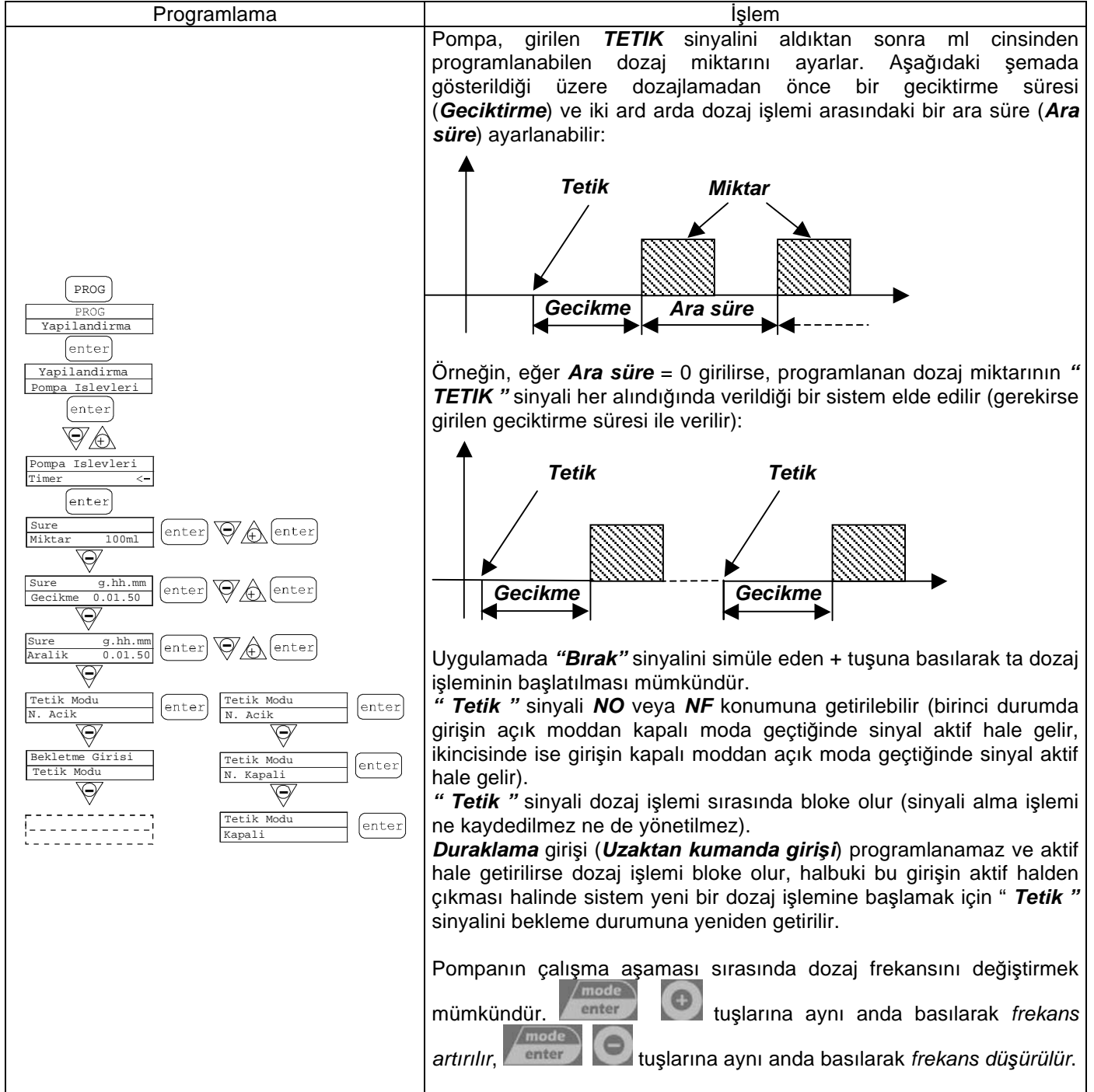

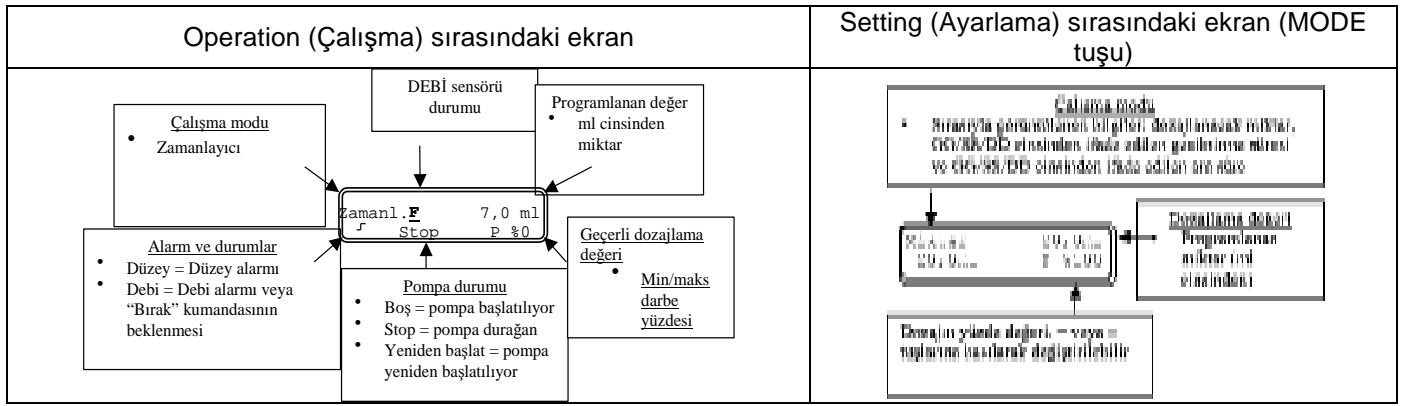

Paragraph 8 – Timed Dosage (Zamanlanmış Dozajlama) (“TETİK” aktif hale getirilmemiş durumda)

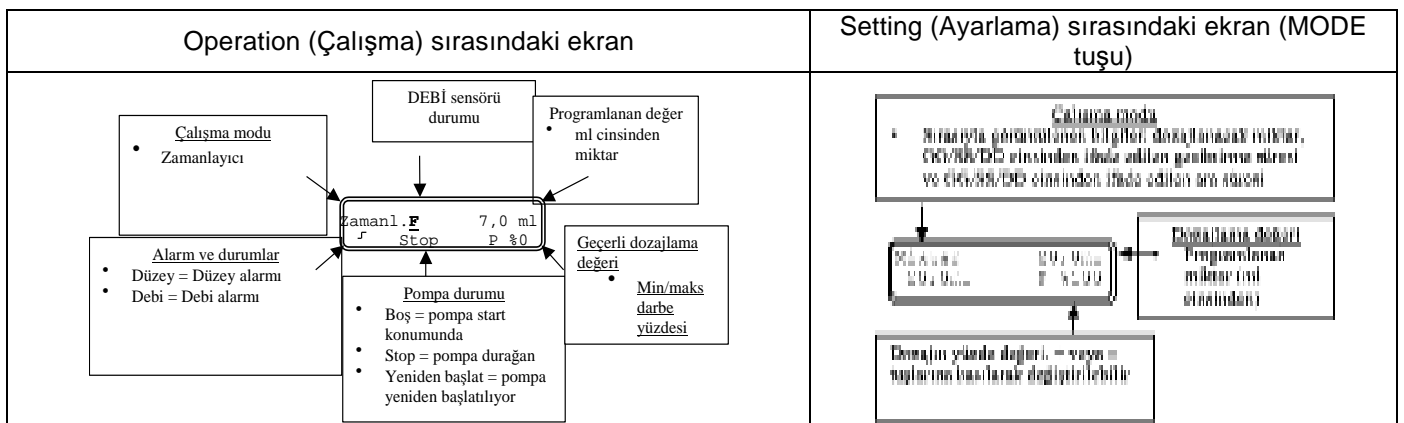
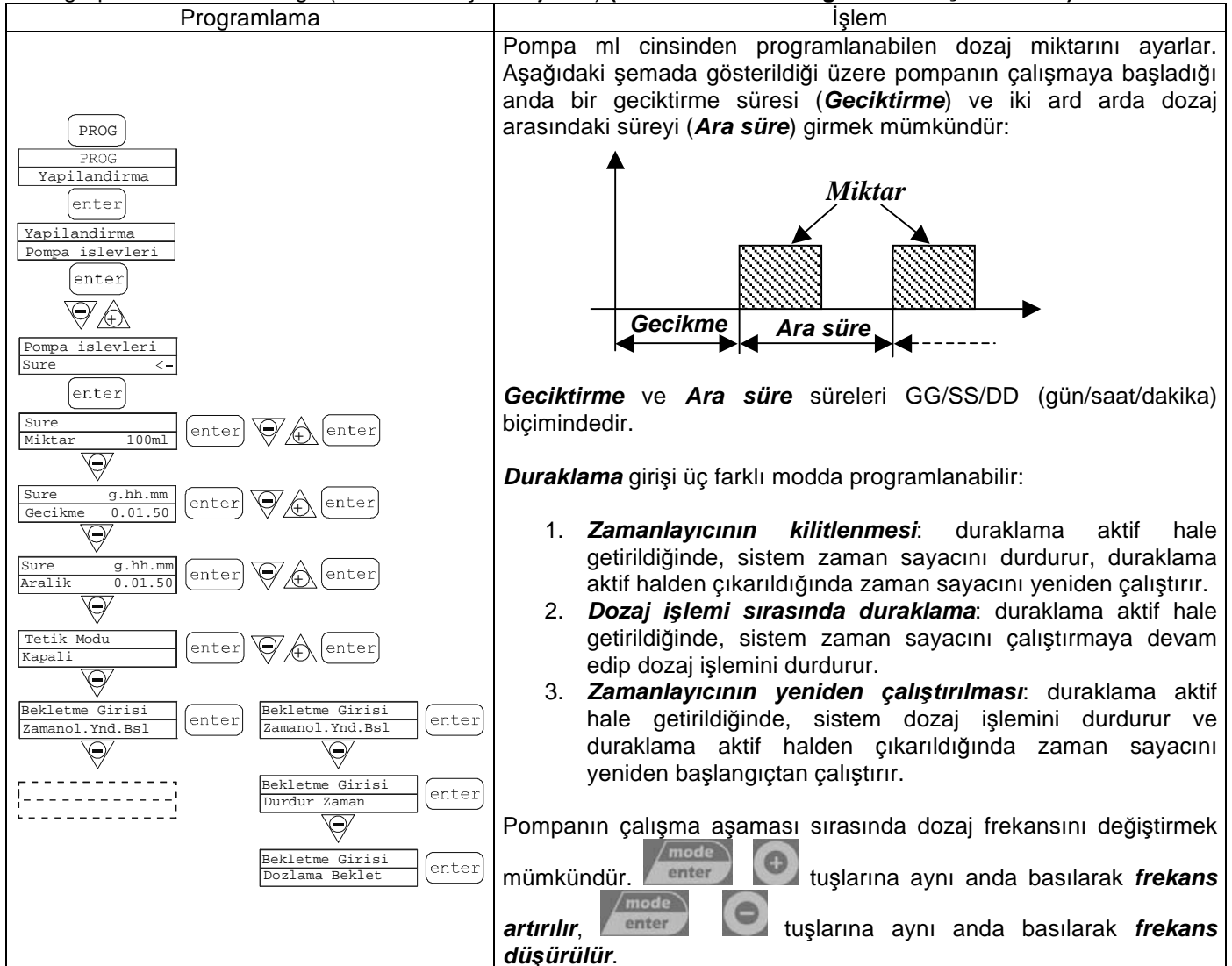

Paragraf 13 – Password (Parola)

Programlama	İşlem
<p>The screenshot shows the 'PROG' menu with 'Yapilandirma' selected. A dashed box indicates the next step. The 'Sifre' field is shown with '****' and '0000' after pressing 'enter'.</p>	<p>Parolayı girerek programlama menüsüne girebilir ve ayarlanan tüm değerleri görebilirsiniz. Bu ayarları değiştirmek istediğinizde her defasında parolayı girmeniz istenir.</p> <p>Yanıp sönen çizgi, değiştirilebilir rakamı gösterir. Rakamı (1 ila 9 arasında) seçmek için tuşunu ve değiştirilecek rakamı seçmek için tuşunu kullanın. tuşuna basarak onaylayın. "0000" (varsayılan) ayarlandığında, parola ortadan kaldırılır.</p>

Paragraf 14 – Flow Alarm (Debi Alarmı)

Programlama	İşlem
<p>The screenshot shows the 'PROG' menu with 'Yapilandirma' selected. A dashed box indicates the next step. The 'Debi Alarmi' menu is shown with 'Ac' (On) selected. The 'Telafleri' (Relays) field is shown with '10' and '10' after pressing 'enter'.</p>	<p>Bu ayar, debi sensörünü etkinleştirmeyi (devre dışı bırakmayı) mümkün kılar. Etkinleştirildiğinde (On), bir alarm tetiklenmeden önce pompanın beklediği sinyal sayısı isteğine erişmek için tuşuna basın. tuşuna basıldığında rakam yanıp sönmeye başlar, ardından tuşlarını kullanarak değer ayarlayabilirsiniz. tuşuna basarak onaylayın.</p> <p>Ana menüye dönmek için tuşuna basın. Telaflı işlevi ancak Batch modunda devreye sokulabilir. Pompa akış sensörü tarafından algılanmayan vuruş sayısını tekrar eder. tuşuna basarak pompanın alarm durumuna geçmeden önce telaflı edebileceği maksimum sinyal sayısı görüntülenir. tuşuna basıldığında sayı yanıp sönmeye başlar, daha sonra tuşlarıyla değer girilir. tuşuyla onay verilir. tuşuna basılarak ana menüye dönlür.</p>

Paragraf 15 – Level Alarm (Düzey Alarmı)

Programlama	İşlem
<p>The screenshot shows the 'PROG' menu with 'Yapilandirma' selected. A dashed box indicates the next step. The 'Seviye Alarmi' menu is shown with 'Stop' selected. The 'Alarm' field is shown with 'Alarm' and 'Alarm' after pressing 'enter'.</p>	<p>Bu ayar, düzey sensörü alarmı etkin durumdayken pompanın ayarlanmasına olanak sağlar. Başka bir deyişle, dozajlamayı durdurmayı (Stop) veya dozajlamayı durdurmadan yalnızca alarm sinyalini etkinleştirmeyi seçebilirsiniz.</p> <p> tuşuna basıp ardından yeni değeri girmek için tuşlarına basılarak değişiklik yapılabilir. tuşuna basarak onaylayın. Ana menüye dönmek için tuşuna basın</p>

Paragraf 16 – Flow Display Unit (Debi Görüntüleme Birimi)

Programlama	İşlem
	<p>Bu ayar, ekranda görüntülenecek dozajlama ölçü biriminin ayarlanmasına olanak sağlar.</p> <p>Değişiklikler, tuşuna basıp ardından ölçü birimini ayarlamak için tuşları ile L/h (litre/saat), Gph (Galon/saat), ml/m (milimetre/dakika) veya standart (ayarlarla bağlı olarak % veya frekans) seçenekleri arasından seçim yapıp ölçü birimi ayarlanarak yapılabilir. Onaylamak ve ana menüye dönmek için tuşuna basın</p>

Paragraf 17 - Setting the Pause (Duraklamayı Ayarlama)

Programlama	İşlem
	<p>Pompa, uzaktan giriş ile duraklatılabilir. Fabrika ayarı Normally Open (Normalde Açık) ayarıdır.</p> <p> tuşuna basıp ardından yeni değeri (N. OPEN (N. AÇIK) veya N. CLOSED (N. KAPALI)) girmek için tuşlarına basılarak değişiklik yapılabilir.</p> <p>Onaylamak ve ana menüye dönmek için tuşuna basın</p>

Gosterge Kontrast Ayari

Gostergenin kontrast ayarini degistirmek icin tusuna basili tutun ve 5 saniye icinde arttirmak yada azaltmak icin yada tuslarına basin.

Alarmlar

Ekran	Nedeni	Kesinti
<p>Sabit alarm LED'i Yanıp sönen "Lev" iletisi Örn. Man Lev P100%</p>	Pompa durdurulmadan düzey alarmının sonlandırılması	Sıvı seviyesini düzeltin.
<p>Sabit alarm LED'i Yanıp sönen "Lev" ve "stop" iletisi Örn. Man Lev Stop P100%</p>	Pompa durdurularak düzey alarmının sonlandırılması	Sıvı seviyesini düzeltin.
<p>Yanıp sönen "Mem" iletisi Örn. 1:n 6 Mem</p>	Bellek işlevi Off (Kapalı) durumdayken pompa bir veya birden çok darbe alır	tuşuna basın
<p>Yanıp sönen "Mem" iletisi Örn. 1:n M 6 Mem</p>	Bellek işlevi On (Açık) durumdayken pompa bir veya birden çok darbe alır	Pompa harici darbe alımını bitirdiğinde, hafızaya alınan vuruşlara döner
<p>Sabit alarm LED'i Yanıp sönen "Flw" iletisi Örn. Man F Flw P100%</p>	Etkin debi alarmı. Pompa, debi sensöründen programlanan sayıda sinyal almamıştır.	tuşuna basın
<p>Örn. Parameter Error PROG to default</p>	Dahili işlemci iletişim hatası.	Varsayılan parametreleri geri yüklemek için tuşuna basın.

Панель управления насоса DOSATec модель LMS

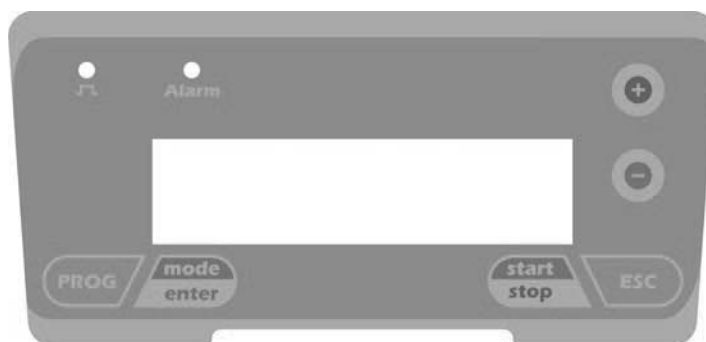

	Вход в меню программирования (нажать на 3 секунды)
	В режиме работы насоса показывает на дисплее программируемые значения. При одновременном нажатии с клавишей или увеличивает или уменьшает значение программируемого параметра. В режиме программирования выполняет функцию «ввод», подтверждающую выбор уровня меню и программируемого значения.
	Запускает и останавливает насос. В случае срабатывания сигнализации низкого уровня (только функция аварийной сигнализации), сигнализации расхода и сигнализации активной памяти отключает сигнал на дисплее.
	Используется для выхода из меню. Перед окончательным выходом из режима программирования появляется запрос на подтверждение сохранений изменений.
	Используется для перемещения по меню или для увеличения численных значений параметров программирования. Может использоваться для запуска дозирования в режиме Batch (доза).
	Используется для перемещения по меню или для уменьшения численных значений параметров программирования.
	Зеленый светодиод, мигает во время дозирования
	Красный светодиод, загорается при аварийных ситуациях.

На заводе-изготовителе установлен режим работы насоса в постоянном режиме.
Насос автоматически возвращается в режим работы после 1 минуты бездействия.
Данные, введенные при таких условиях, не сохраняются.

Электрические присоединения

	1	Реле сигнализации	
	2		
	3	"+"	Вход сигнала 4-20 мА (максимум 200 Ом)
	4	"-"	
	5	Удалённое управление насосом (старт/стоп)	
	6		
	7	Вход частотного сигнала / сигнала от водосчётчика	
	8	с импульсным выходом	
	9	Вход датчика потока	
	10		
B	Вход датчика уровня		

Меню программирования DOSATec LMS

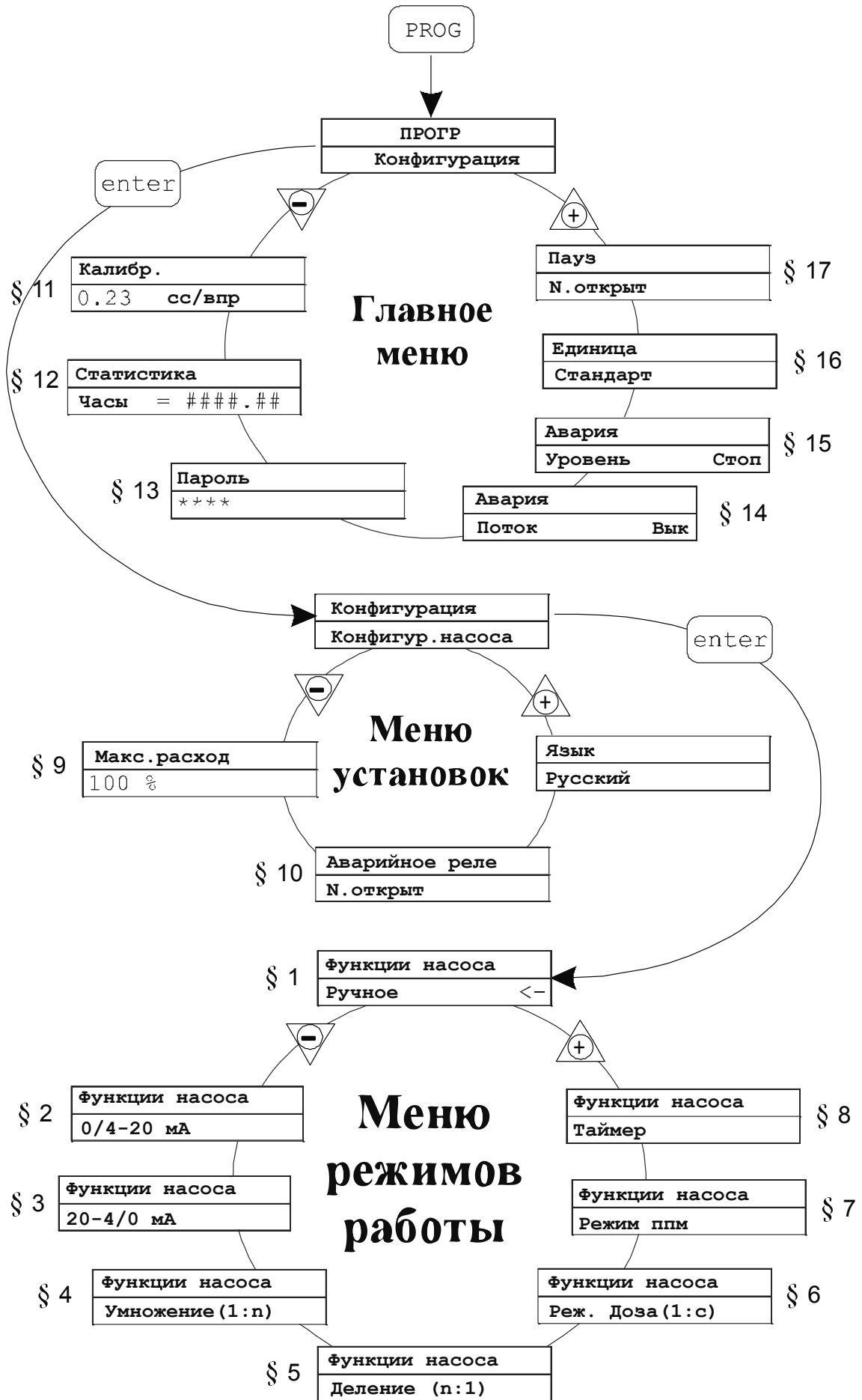

Программирование насоса-дозатора

Выбор языка

Алгоритм	Описание
<pre> graph TD A[PROG] --> B[ПРОГР] B --> C[Конфигурация] C --> D[enter] D --> E[Конфигурация Конфигур. насоса] E --> F[Max. расход P100%] F --> G[Аварийное реле N. открыт] G --> H[Язык Русский] H --> I[enter] I --> J[confirm with arrow keys] J --> K[confirm with arrow keys] K --> L[] </pre>	<p>На заводе - изготовителе в качестве языка меню установлен английский язык.</p> <p>Возможно изменение языка, доступные языки:</p> <ul style="list-style-type: none"> • Испанский • Итальянский • Немецкий • Французский <p>Для изменения языка меню:</p> <ol style="list-style-type: none"> 1. Нажмите кнопку (3 сек), для входа в режим программирования, далее , далее или до появления меню "Language" 2. Нажмите кнопку для входа в меню, затем или для установки нового значения. 3. Нажмите кнопку для подтверждения выбора и возврата в основное меню.

§ 1 – Ручной режим дозирования

Алгоритм	Описание
<pre> graph TD A[PROG] --> B[ПРОГР] B --> C[Конфигурация] C --> D[enter] D --> E[Конфигурация Конфигур. насоса] E --> F[enter] F --> G[Конфигур. насоса Ручное] G --> H[enter] H --> I[] </pre>	<p>На заводе - изготовителе в качестве режима работы установлен ручной режим дозирования.</p> <p>Производительность насоса можно регулировать.</p> <p>Для увеличения подачи реагента - одновременно нажмите кнопки и </p> <p>Для уменьшения подачи реагента – одновременно кнопки и .</p> <p>Индикация подачи зависит от выбранных единиц измерения (§ 16)</p>

Дисплей в режиме работы	Дисплей в режиме программирования
<p>Режим работы</p> <ul style="list-style-type: none"> • Man = ручной <p>Состояние датчика потока</p> <p>Текущая производительность</p> <ul style="list-style-type: none"> • % от максимальной производительности, частота, л/ч, грп, мл/мин <p>Сигнализация и статус</p> <ul style="list-style-type: none"> • Lev = уровень • Flw = поток <p>Состояние насоса</p> <ul style="list-style-type: none"> • Empty – в работе • Stop – остановлен • Paus – пауза <p>Display content: MAN, F, Lev, Stop, P100%</p>	<p>Режим работы (Man) / Соответствующее значение частоты</p> <p>Display content: MAN, P100%</p> <p>Текущая производительность</p> <ul style="list-style-type: none"> • % от максимальной производительности, частота, л/ч, грп, мл/мин

§ 2 – Дозирование пропорционально сигналу 0/4 – 20 мА

Алгоритм	Описание
	<p>Насос дозирует пропорционально токовому сигналу 0/4 – 20 мА.</p> <p>На заводе - изготовителе запрограммировано:</p> <ul style="list-style-type: none"> • Остановка насоса при сигнале 4 мА (нижняя точка) • Работа насоса с максимальной частотой при сигнале 20 мА. (верхняя точка) <p>Указанные настройки возможно изменить в режиме программирования.</p> <p>Максимальная частота может быть изменена в режиме работы при одновременном нажатии кнопок и или и .</p>

Дисплей в режиме работы	Дисплей в режиме программирования

§ 3 – Дозирование пропорционально сигналу 20 – 4/0 мА

Алгоритм	Описание
	<p>Насос дозирует пропорционально токовому сигналу 20 - 4/0 мА.</p> <p>На заводе - изготовителе запрограммировано:</p> <ul style="list-style-type: none"> • Остановка насоса при сигнале 20 мА (нижняя точка) • Работа насоса с максимальной частотой при сигнале 4 мА. (верхняя точка) <p>Указанные настройки возможно изменить в режиме программирования.</p> <p>Максимальная частота может быть изменена в режиме работы при одновременном нажатии кнопок и или и .</p>

Дисплей в режиме работы	Дисплей в режиме программирования

§4 Дозирование пропорционально внешнему импульсу (множитель сигнала)

Алгоритм	Описание
<p>PROG ПРОГР Конфигурация enter Конфигурация Конфигур. насоса enter Функции насоса Умножение (1:n) <- enter Умножение (1:n) n 4 enter Умножение (1:n) Таймаут 0s enter Умножение (1:n) Память Вык enter</p>	<p>Насос-дозатор работает от источника внешних импульсных сигналов (замыкание контактов №№ 7 и 8), на каждый получаемый сигнал насос делает "n" впрысков. Частота впрысков определяется самим насосом на основании промежутка времени между импульсами и корректируется после получения каждого последующего импульса, обеспечивая наиболее возможную регулярность дозации.</p> <p>Возможно установить время (функция "Таймаут"), после которого насос перепрограммирует частоту интервала между впрысками</p> <p>Насос имеет функцию "Память", которая позволяет запоминать все полученные импульсы и выполнять впрыски после окончания получения всех сигналов. Число "n" возможно изменить в режиме работы, нажав одновременно кнопки и для его увеличения или нажав одновременно кнопки и для его уменьшения.</p>

Дисплей в режиме работы	Дисплей в режиме программирования
<p>Режим работы • 1 n = умножение сигнала</p> <p>Сигнализация и состояние • Lev = уровень • Flw = поток • Mem = память</p> <p>Состояние датчика потока</p> <p>Состояние функции "Память"</p> <p>Параметр программирования • Значение "n"</p> <p>Текущее состояние дозирования • Количество оставшихся впрысков</p> <p>Состояние насоса • Empty – в работе • Stop - остановлен • Paus - пауза</p>	<p>Программируемые величины • Длительность тайм-аута, сек</p> <p>Timeout 0s n 1</p> <p>Текущая подача (число "n"), для изменения нажмите кнопку "+" или "-"</p>

§5 Дозирование пропорционально внешнему импульсу (делитель сигнала)

Алгоритм	Описание
	<p>Насос-дозатор работает от источника внешних импульсных сигналов (замыкание контактов №№ 7 и 8), на каждые "n" получаемых сигналов насос делает один впрыск.</p> <p>Число "n" возможно изменить в режиме работы, нажав одновременно кнопки и для его увеличения или нажав одновременно кнопки и для его уменьшения.</p>

Дисплей в режиме работы	Дисплей в режиме программирования

§6 Дозирование пропорционально внешнему сигналу (режим "Доза")

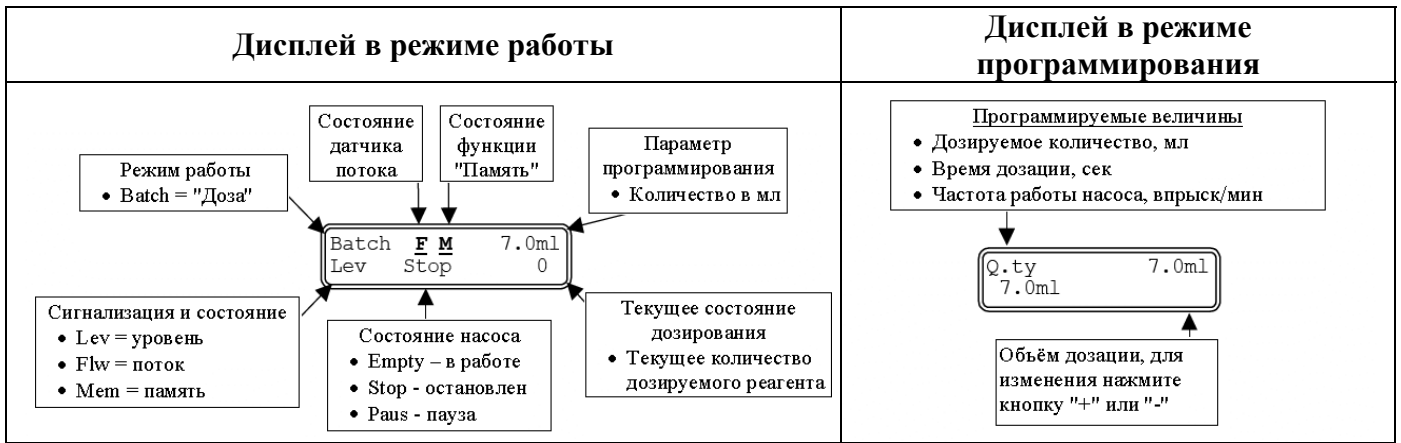

Алгоритм	Описание
	<p>Насос-дозатор работает от источника внешних импульсных сигналов (замыкание контактов №№ 7 и 8), Устанавливаемые параметры – объем реагента, который необходимо подать и время, в течение которого это необходимо сделать</p> <p>Насос имеет функцию "Память", которая позволяет запоминать все полученные импульсы и выполнять впрыски после окончания получения всех сигналов. Дозация может быть инициирована в ручном режиме при нажатии кнопки или замыкании контактов №№ 5 и 6. Кнопка прерывает дозацию, которая может быть продолжена повторным нажатием кнопки или начата заново при нажатии кнопки </p> <p>Подачу насоса можно изменить в режиме работы. Для увеличения подачи реагента - одновременно нажмите кнопки и Для уменьшения подачи реагента – одновременно кнопки и .</p>

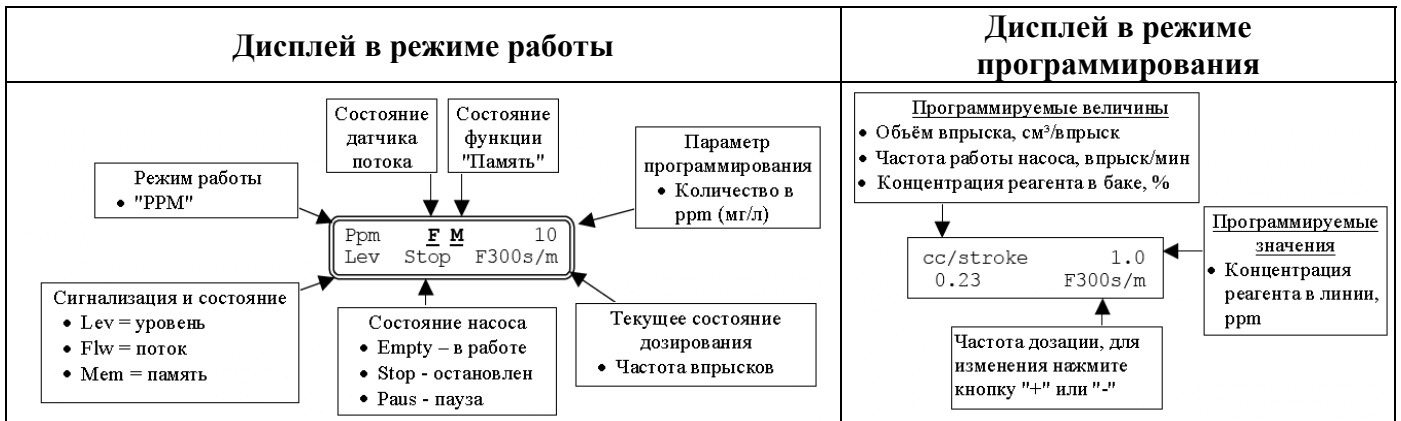
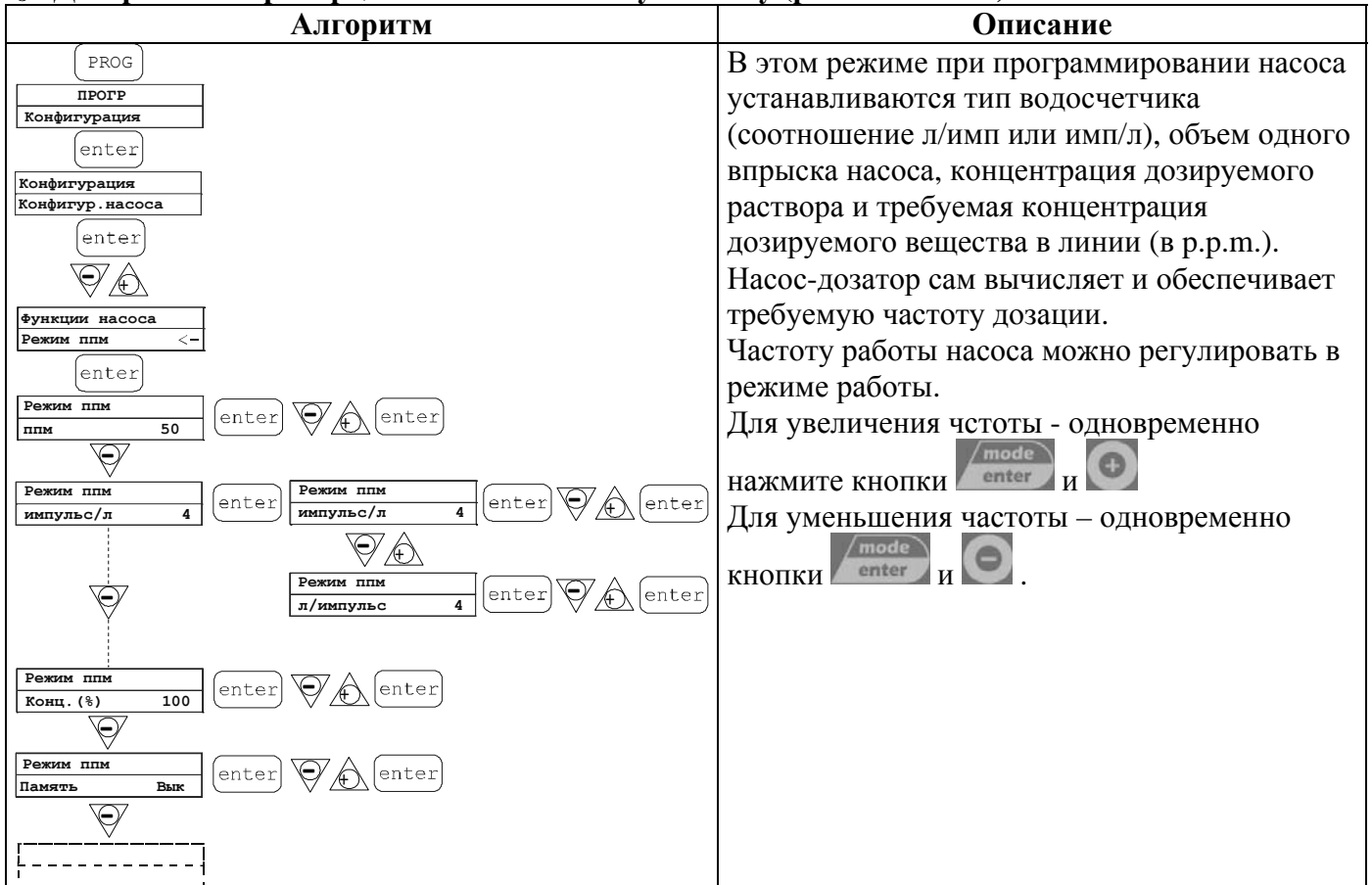

§7 Дозирование пропорционально внешнему сигналу (режим "PPM")



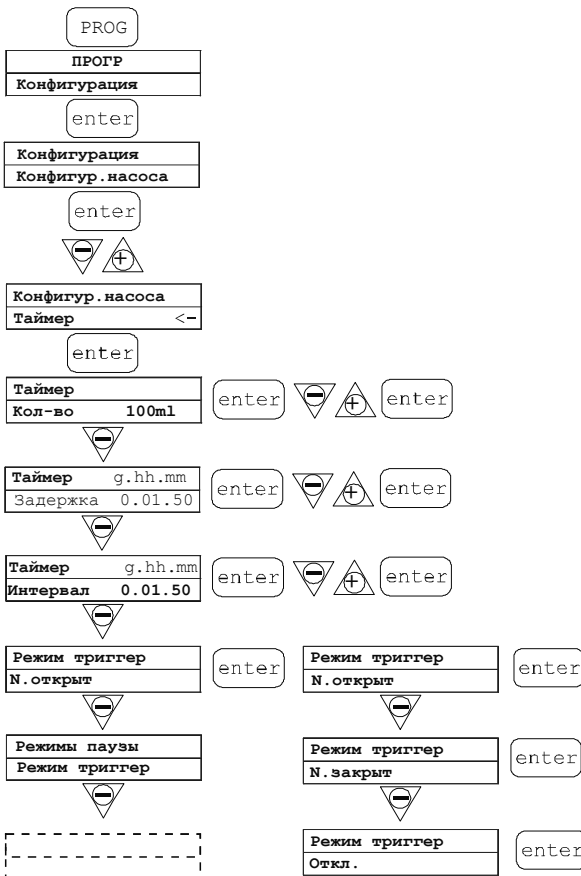
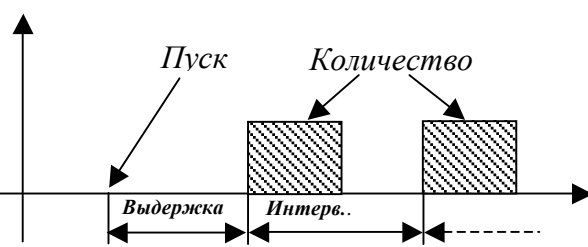
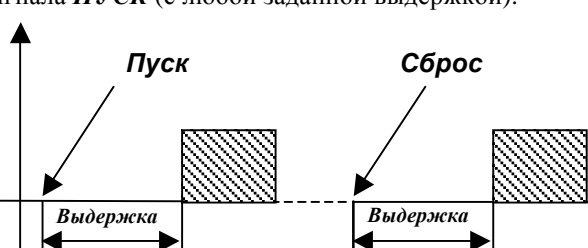



§ 8 – Дозировка по таймеру (Частотный входной сигнал «ПУСК» активирован)

Настройка	Принцип работы
 <p> ПРОГ ПРОГР Конфигурация enter Конфигурация Конфигур. насоса enter Конфигур. насоса Таймер <- enter Таймер Кол-во 100ml Таймер g. hh. mm Задержка 0.01.50 Таймер g. hh. mm Интервал 0.01.50 Режим триггер N. открыт Режим триггер N. закрыт Режим паузы Режим триггер Откл. </p>	<p>После получения набора сигналов ПУСК насос дозирует заданное количество в мл. Можно задать выдержку времени перед дозировкой (Выдержка) и интервал между последовательными дозировками (Интерв.), как показано на схеме:</p>  <p>Например, при установке времени Интервала на 0 дозировка заданного количества будет осуществляться после каждого сигнала ПУСК (с любой заданной выдержкой):</p>  <p>Можно запустить дозировку нажатием на клавишу +, которая практически имитирует сигнал Пуск. Сигнал Пуск можно установить на Н. открыто (активируется при переходе входного сигнала из открытого режима в закрытый) или на Н. закрыто (активируется при переходе входного сигнала из закрытого режима в открытый). Во время дозировки сигнал Пуск блокируется (при поступлении не сохраняется и не обрабатывается). Входной сигнал Пауза (Дистанционный сигнал) нельзя запрограммировать. При его активации дозировка прекращается, а при последующей деактивации система возвращается в режим ожидания сигнала Пуск для новой дозировки.</p> <p>Частоту дозировки можно менять во время работы насоса, одновременно нажимая на клавиши  для увеличения частоты или клавиши  для ее уменьшения.</p>

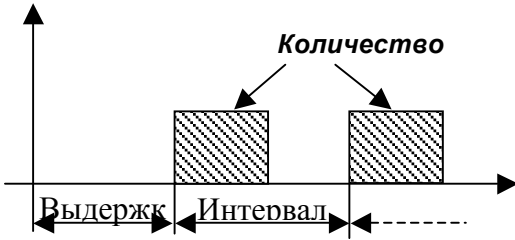



Дисплей во время работы	Дисплей во время настройки (клавиша MODE)
 <p> Режим работы • Таймер </p> <p> РАСХОД состояние датчика расхода </p> <p> Заданное значение • Количество в мл </p> <p> Таймер 7,0 ml Stop P 0% </p> <p> Текущее значение дозировки • Макс. число ходов/мин в % </p> <p> Состояние насоса • Dry = запуск насоса • Stop = остановка насоса • Restart = перезапуск насоса </p> <p> Аварийные сигналы и состояния • Liv = сигнал уровня • Flow = сигнал расхода или ...ожидание сброса </p>	<p> Режим работы • Последовательное отображение следующей информации: дозируемое количество, выдержка в д.чч.мм и интервал в д.чч.мм </p> <p> Значение дозировки • Заданное количество в мл </p> <p> Q. t à 20,0ml P 100% </p> <p> Значение дозировки в %, которое можно изменить нажатием на клавиши + или - </p>

§ 8 – Дозировка по таймеру (Частотный входной сигнал «TRIGGER» не активирован)





Настройка	Принцип работы
<p> (PROG) ПРОГР Конфигурация (enter) Конфигурация Конфигур. насоса (enter) (▼) (▲) Конфигур. насоса Таймер <- (enter) Таймер (enter) (▼) (▲) (enter) Кол-во 100ml (▼) Таймер g.hh.mm (enter) (▼) (▲) (enter) Задержка 0.01.50 (▼) Таймер g.hh.mm (enter) (▼) (▲) (enter) Интервал 0.01.50 (▼) Режим триггер (enter) (▼) (▲) (enter) Откл. (▼) Режимы паузы (enter) Режимы паузы (enter) Рестарт таймера Рестарт таймера (▼) Режимы паузы (enter) Заморозка врем. (▼) Режимы паузы (enter) Пауза дозир. </p>	<p>Насос дозирует заданное количество в мл. Можно задать выдержку времени (Выдержка) при запуске насоса и интервал между двумя последовательными дозировками (Интервал), как показано на схеме:</p>  <p>Значения Выдержки и Интервала указываются в формате дд.чч.мм (дни, часы, минуты)</p> <p>Ввод сигнала Паузы может осуществляться в трех разных режимах:</p> <ol style="list-style-type: none"> 1. Заморозка времени: при активации паузы система останавливает отсчет текущего времени и возобновляет его после выключения паузы. 2. Приостановка дозировки: при активации паузы система продолжает вести отсчет времени, а дозировка приостанавливается. 3. Перезапуск таймера: при активации паузы система останавливает дозировку, а при выключении паузы отсчет начинается сначала. <p>Частоту дозировки можно менять во время работы насоса, одновременно нажимая на клавиши   для увеличения частоты или клавиши   для ее уменьшения.</p>

Индикация во время работы	Индикация при запуске (клавиша MODE)
<p> Режим работы • Таймер </p> <p> Состояние датчика РАСХОДА </p> <p> Задаваемое значение • Количество в мл </p> <p> Текущее значение дозировки: • Макс. число ходов/мин в % </p> <p> Состояние насоса • Dry = запуск насоса • Stop = остановка насоса • Restart = перезапуск насоса </p> <p> Аварийные сигналы и состояния уровня = сигнал уровня • Flow = сигнал расхода </p> <p> Timer F 7.0 ml Liv Stop P 0% </p>	<p> Режим работы • Последовательное отображение следующей информации: дозируемое количество, выдержка в дд.чч.мм и интервал в дд.чч.мм </p> <p> Значение дозировки Заданное количество в мл </p> <p> Значение дозировки в %, которое можно изменить нажатием на клавиши + или - </p> <p> Q. tà 20,0ml 20,0ml P 100% </p>

§ 9 Установка максимальной подачи насоса

Алгоритм	Описание
	<p>Для установки максимальной подачи насоса.</p> <p>На дисплее высвечивается подача насоса в заданных единицах измерения (процент от максимальной производительности или частота).</p> <p>Для изменения нажмите кнопку , затем используйте кнопки   для установки нового значения.</p> <p>Для подтверждения и возврата в основное меню нажмите .</p>

§ 10 Установка реле аварийной сигнализации

Алгоритм	Описание
	<p>Для сигнализации аварийной ситуации можно установить замыкание нормально разомкнутых контактов (по умолчанию) или размыкание нормально замкнутых контактов.</p> <p>Для изменения нажмите кнопку , затем используйте кнопки   для установки нового значения.</p> <p>Для подтверждения и возврата в основное меню нажмите .</p>

§ 11 Калибровка подачи насоса

Алгоритм	Описание
	<p>Насос сохраняет в памяти объём 1 впрыска, значение которого использует в расчётах подачи.</p> <p>Объём впрыска можно откалибровать:</p> <p>В ручном режиме (manual) – вводится объём 1 впрыска (в кубических сантиметрах) с помощью кнопок . Введенное значение подтверждается кнопкой .</p> <p>В автоматическом режиме (automatic) – насос делает 100 впрысков при нажатии кнопки . Далее с помощью кнопок вводится объём <u>100 впрысков</u>, введенное значение подтверждается кнопкой .</p>

§ 12 Статистика

Алгоритм	Описание
	<p>В главном меню на дисплее высвечивается время работы насоса.</p> <p>Нажав кнопку , можно получить доступ к следующей статистике:</p> <ul style="list-style-type: none"> • Strokes = количество впрысков, сделанных насосом • Q.ty (L) = объем дозируемого насосом реагента в литрах; рассчитанный на основании значения объёма 1 впрыска • Power = количество запусков насоса <p>С помощью кнопок можно обнулить счетчики (Reset/Сброс). Подтверждение действия – с помощью кнопки .</p>





§ 13 Пароль

Алгоритм	Описание
	<p>Установка пароля позволяет исключить несанкционированный доступ в меню программирования и изменение настроек насоса. Значение “0000” (по умолчанию) отменяет пароль.</p> <p>Для установки пароля:</p> <p>С помощью кнопки для выберите цифру (от 0 до 9), с помощью кнопки выберите регистр, подлежащий изменению.</p> <p>Подтверждение выбранного значения - нажатием кнопки .</p>





§14 Сигнализация потока

Алгоритм	Описание
	<p>После подключения к насосу датчика потока и активации режима работы (On), нажмите кнопку для программирования количества сигналов, не получив которых насос включает сигнализацию.</p> <p>Для входа в режим изменения нажмите кнопку . Для выбора значения нажмите кнопки или . Подтверждение выбранного режима - нажатием кнопки . Для возврата в основное меню нажмите .</p> <p>Только в режиме дозирования Batch возможно активировать режим Рекуперация. Насос повторяет количество ходов, не полученных датчиком потока.</p> <p>При нажатии кнопки выполняется запрос максимального количества сигналов, которые насос может восстановить до перехода в аварийное состояние. Нажать , начинает мигать число, затем с помощью кнопок задать значение. Подтвердить, нажав . Нажать для возврата в основное меню.</p>





§ 15 Сигнализация низкого уровня

Алгоритм	Описание
	<p>При подключенном к насосу датчике уровня реагента в баке можно выбрать один из двух режимов работы сигнализации:</p> <ul style="list-style-type: none"> Активация сигнала тревоги и остановка дозирования при снижении уровня до критического или Активация сигнала тревоги без остановки дозирования. <p>Для изменения режима работы нажмите кнопку , затем с помощью кнопок   установите режим работы сигнализации. Подтверждение выбранного режима - нажатием кнопки . Для возврата в основное меню нажмите .</p>

§16 Единица измерения подачи



Алгоритм	Описание
	<p>Для удобства работы можно выбрать единицы измерения, показываемые на дисплее. Возможные варианты:</p> <ul style="list-style-type: none"> Процент / частота впрысков. L/h (литры/час) Gph (галлоны/час) ml/m (миллилитры/минуту) <p>Для изменения единиц измерения нажмите кнопку , затем с помощью кнопок   установите единицы измерения. Подтверждение выбранного режима – нажатием кнопки . Для возврата в основное меню нажмите .</p>





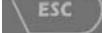

§ 17 Установка паузы

Алгоритм	Описание
	<p>Насос может быть остановлен сигналом с пульта оператора в случае удалённого управления. Установка завода - изготовителя – замыкание нормально разомкнутых контактов. Возможная настройка - размыкание нормально замкнутых контактов.</p> <p>Вход в режим изменения – с помощью кнопки .</p> <p>Изменение установки – с помощью кнопок  . Подтверждение установленного значение – с помощью кнопки .</p>

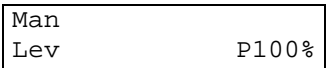
Регулирование контраста дисплея

Для входа в режим регулировки контраста в дисплей удерживайте нажатой кнопку  в течении 5 секунд.

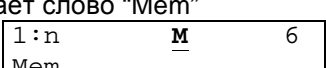
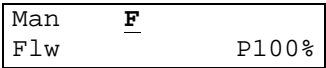
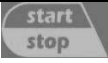
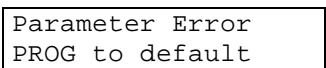
Далее используйте кнопки  or  для повышения и понижения контраста дисплея..

Дисплей	Причина	Действие
Постоянная аварийная сигнализация LED Мигает слово "Lev"  пример	Аварийная сигнализация нехватки реагента в баке без остановки работы насоса	Долейте реагент
Постоянная аварийная сигнализация LED Мигает слово "Lev и слово "stop"  пример	Аварийная сигнализация нехватки реагента в баке с остановкой работы насоса	Долейте реагент
Мигает слово "Mem"  пример	Насос получает один или более импульсов в процессе дозирования при выключенной функции памяти	Нажмите кнопку 
Мигает слово "Mem"  пример	Насос получает один или более импульсов в процессе дозирования при включенной функции памяти	Когда насос закончит получение внешних импульсов он возвратится к введенным в память впрыскам.
Постоянная аварийная сигнализация LED Мигает слово "Flw"  пример	Активна аварийная сигнализация потока. Насос не получает запрограммированное количество сигналов от датчика потока. Только в режиме дозирования Batch: если задан режим Рекуперация, F мигает, и аварийный сигнал сообщает, что насос не получил от датчика потока максимальное количество заданных сигналов.	Нажмите кнопку 
 пример	Внутренняя ошибка программного обеспечения	Нажмите кнопку  чтобы загрузить фабричные данные