

**(en) Electric current! Danger to life!**  
Only skilled or instructed persons may carry out the following operations.

**(de) Lebensgefahr durch elektrischen Strom!**

Nur Elektrofachkräfte und elektrotechnisch unterwiesene Personen dürfen die im Folgenden beschriebenen Arbeiten ausführen.

**(fr) Tension électrique dangereuse !**

Seules les personnes qualifiées et averties doivent exécuter les travaux ci-après.

**(es) ¡Corriente eléctrica! ¡Peligro de muerte!**

El trabajo a continuación descrito debe ser realizado por personas cualificadas y advertidas.

**(it) Tensione elettrica: Pericolo di morte!**

Solo persone abilitate e qualificate possono eseguire le operazioni di seguito riportate.

**(zh) 触电危险!**

只允许专业人员和受过专业训练的人员进行下列工作。

**(ru) Электрический ток! Опасно для жизни!**

Только специалисты или проинструктированные лица могут выполнять следующие операции.

**(nl) Levensgevaar door elektrische stroom!**

Uitsluitend deskundigen in elektriciteit en elektrotechnisch geïnstrueerde personen is het toegestaan, de navolgend beschreven werkzaamheden uit te voeren.

**(da) Livsfare på grund af elektrisk strøm!**

Kun uddannede el-installatører og personer der er instruerede i elektrotekniske arbejdsopgaver, må udføre de nedenfor anførte arbejder.

**(el) Προσοχή, κίνδυνος ηλεκτροπληξίας!**

Οι εργασίες που αναφέρονται στη συνέχεια θα πρέπει να εκτελούνται μόνο από ηλεκτρολόγους και ηλεκτροτεχνίτες.

**(pt) Perigo de vida devido a corrente eléctrica!**

Apenas electricistas e pessoas com formação electotécnica podem executar os trabalhos que a seguir se descrevem.

**(sv) Livsfara genom elektrisk ström!**

Endast utbildade elektriker och personer som undervisats i elektroteknik får utföra de arbeten som beskrivs nedan.

**(fi) Hengenvaarallinen jännite!**

Vain pätevät sähköasentajat ja opastusta saaneet henkilöt saavat suorittaa seuraavat työt.

**(cs) Nebezpečí úrazu elektrickým proudem!**

Níže uvedené práce smějí provádět pouze osoby s elektrotechnickým vzděláním.

**(et) Eluohhtik! Elektrilöögiht!**

Järgnevalt kirjeldatud töid tohib teostada ainult elektriala spetsialist või elektrotehnilise instrueerimise läbinud personal.

**(hu) Életveszély az elektromos áram révén!**

Csak elektromos szakemberek és elektrotechnikában képzett személyek végezhetik el a következőkben leírt munkákat.

**(lv) Elektriskā strāva apdraud dzīvību!**

Tālāk aprakstītos darbus drīkst veikt tikai elektrospeciālisti un darbam ar elektrotehnikām iekārtām instruētās personas!

**(lt) Pavojus gyvybei dėl elektros srovės!**

Tik elektrikai ir elektrotechnikos specialistai gali atlikti žemiau aprašytus darbus.

**(pl) Porażenie prądem elektrycznym stanowi zagrożenie dla życia!**

Opisane poniżej prace mogą przeprowadzać tylko wykwalifikowani elektrycy oraz osoby odpowiednio poinstruowane w zakresie elektrotechniki.

**(sl) Življenjska nevarnost zaradi električnega toka!**

Spodaj opisana dela smejo izvajati samo elektrostrokovnjaki in elektrotehnično poučene osebe.

**(sk) Nebezpečenstvo ohrozenia života elektrickým prúdom!**

Práce, ktoré sú nižšie opísané, smú vykonávať iba elektroodborníci a osoby s elektrotechnickým vzdelaním.

**(bg) Опасност за живота от електрически ток!**

Операциите, описани в следващите раздели, могат да се извършват само от специалисти-електротехници и инструктиран електротехнически персонал.

**(ro) Atenție! Pericol electric!**

Toate lucrările descrise trebuie efectuate numai de personal de specialitate calificat și de persoane cu cunoștințe profunde în electrotehnică.

## T3-...-.../I2...

### T3-1(2)-.../I2(H)/(-RT)

### T3-1(2)-.../I2(H)/SVB (-SW)

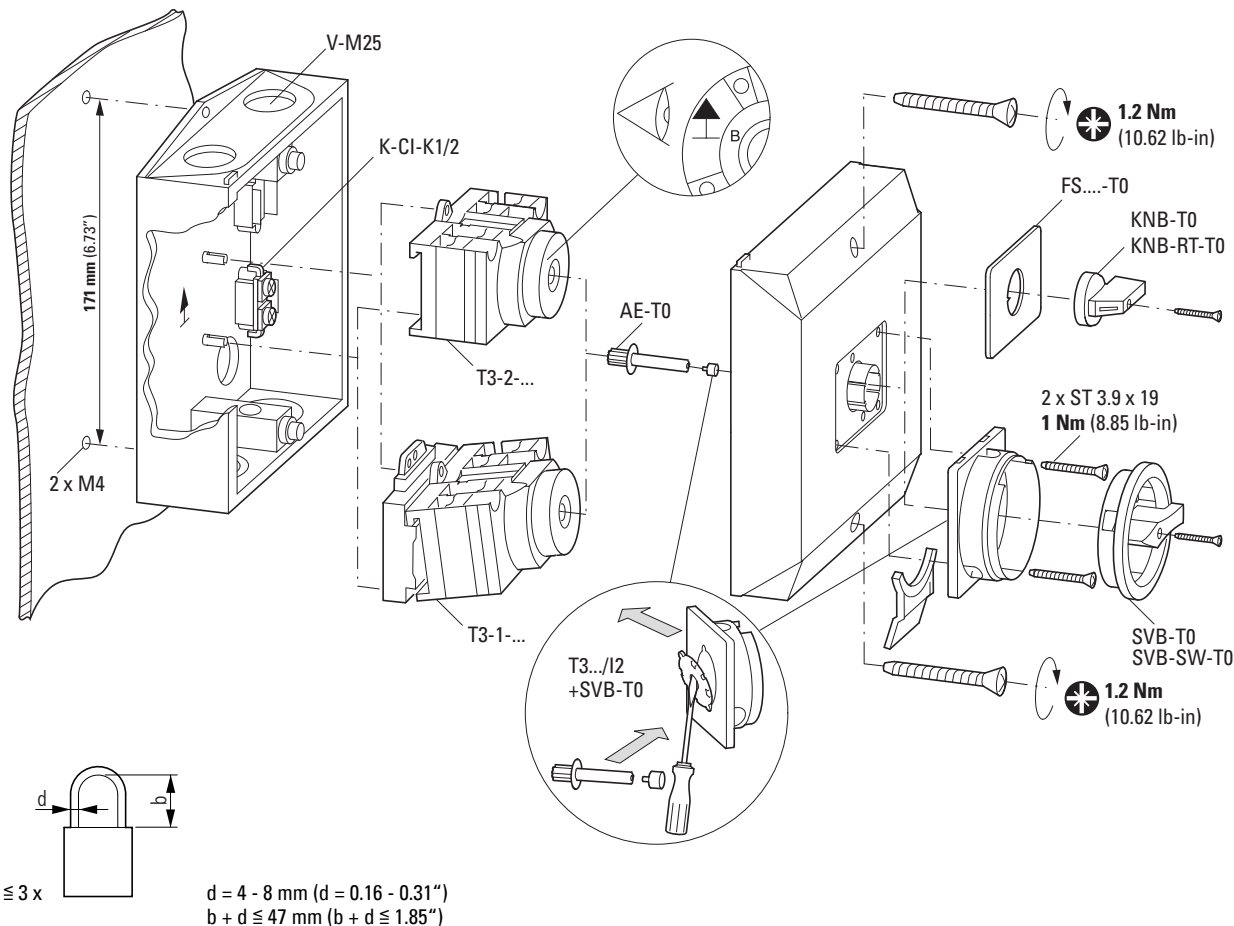
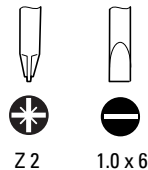

**T3-3(4)(5)-.../I2(H)/(-RT)**  
**T3-3(4)(5)-.../I2(H)/SVB(-SW)**

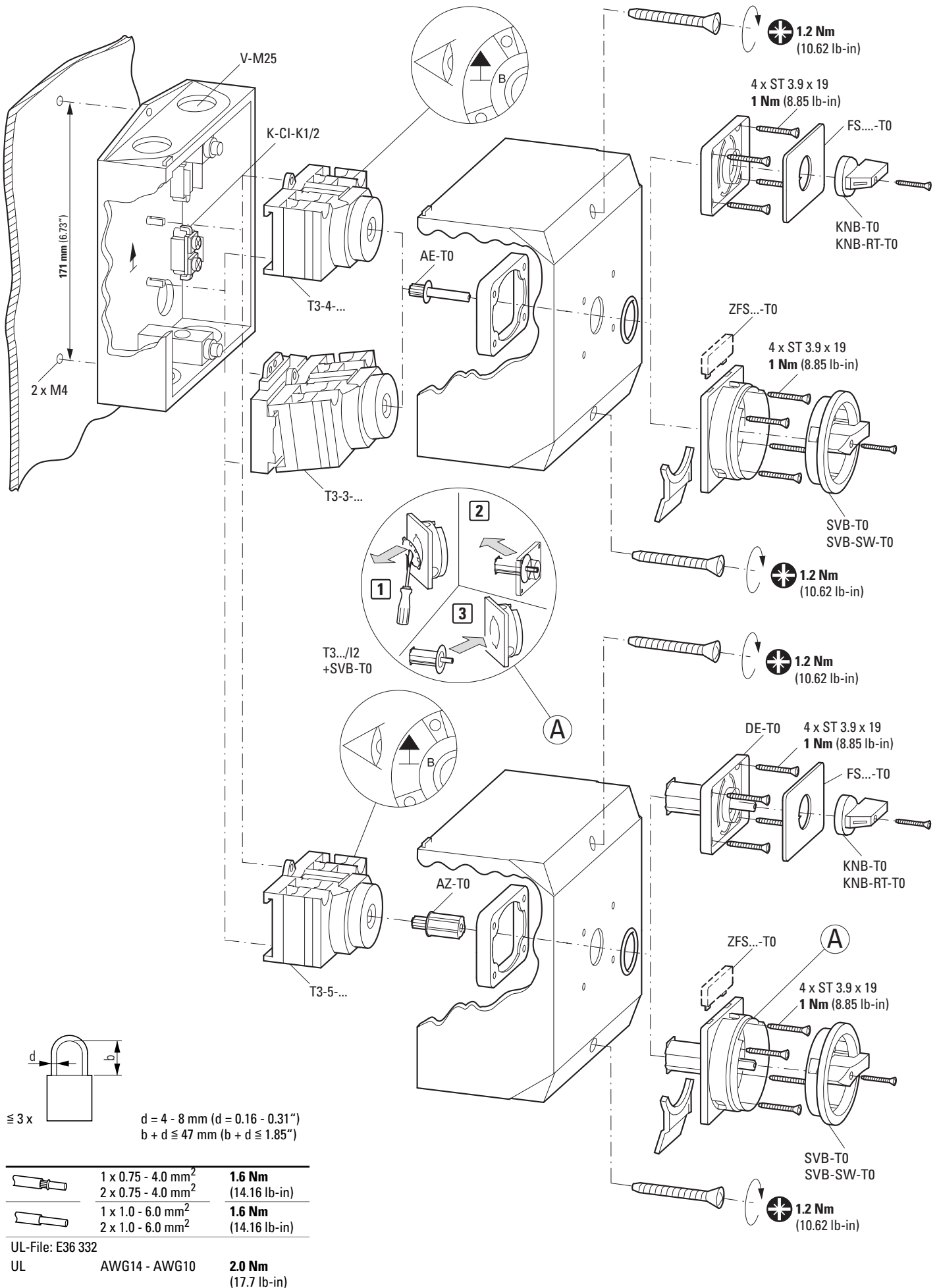

02/13 IL03801008Z

**T3-.../I2...**

T3-.../I2... : V-M25  
 T3-.../I2.../(-NA) :  $\varnothing \leq 16 \text{ mm}$   
 ( $\varnothing \leq 0.63''$ )

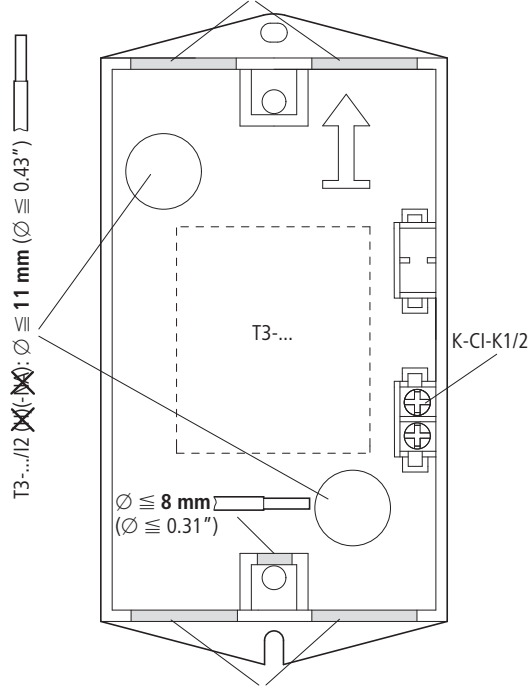

T3-.../I2... : V-M25  
 T3-.../I2.../(-NA) :  $\varnothing \leq 16 \text{ mm}$   
 ( $\varnothing \leq 0.63''$ )

**1 T3-.../I2(H)(-NA)**

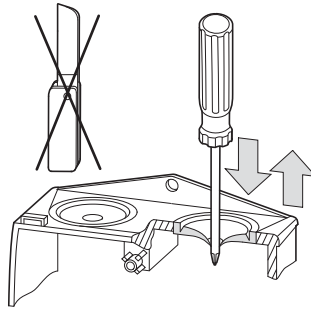

**2**

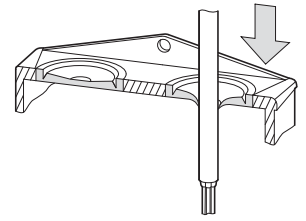

**3**

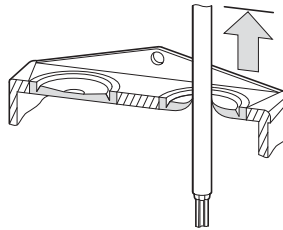

**4**

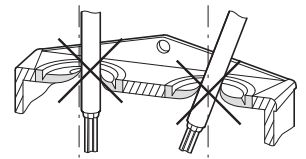

02/13 IL03801008Z

**V-M25**

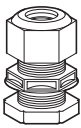

**PG16**

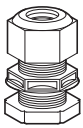

**KT-M25**



**...**

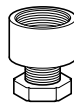

+  
**M25-PG16**

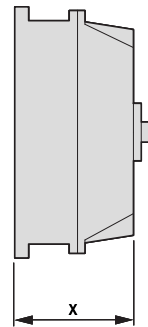

	x [mm]	[in]
T3-1(2)-...	80	3.15
T3-3(4)-...	100	3.94
T3-5...	145	5.71

**1**

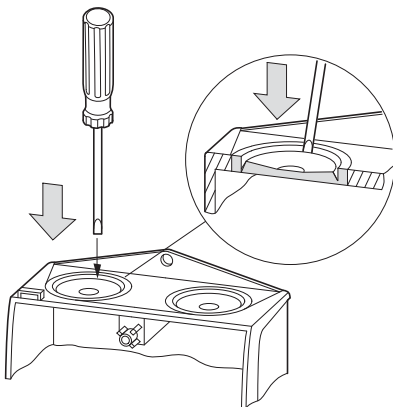

**2**

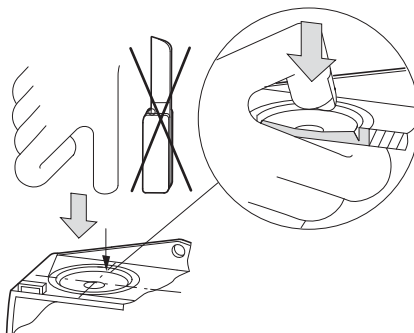

**3**

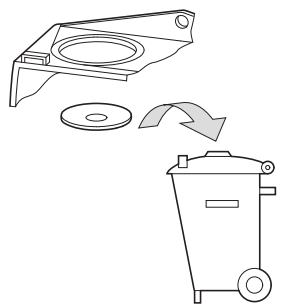

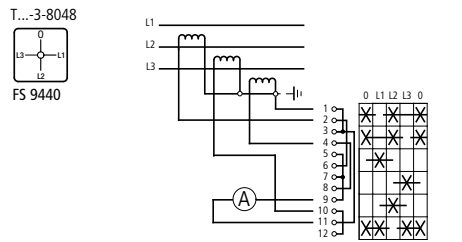
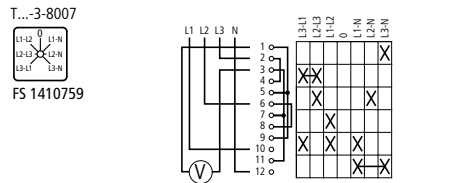
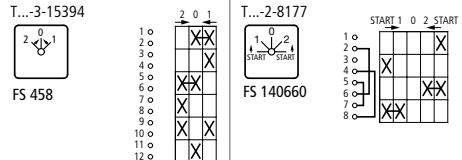
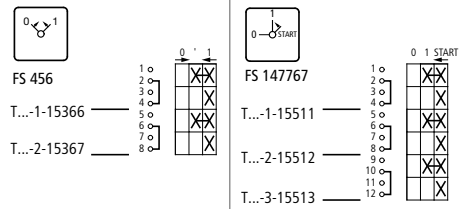
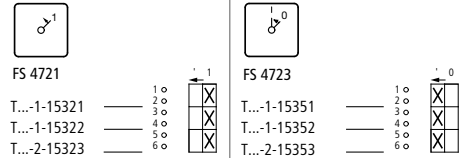
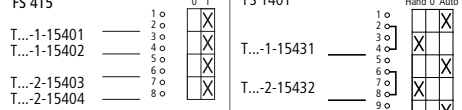
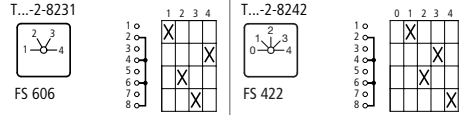
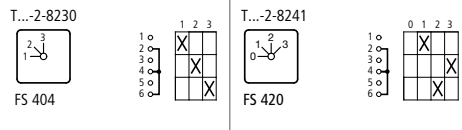
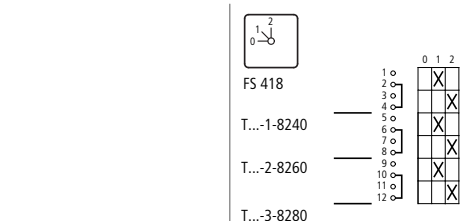
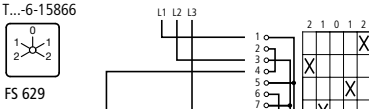
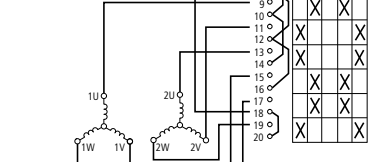
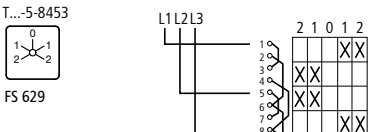
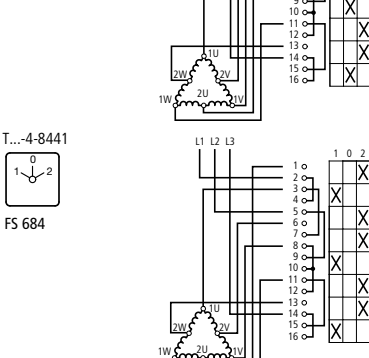
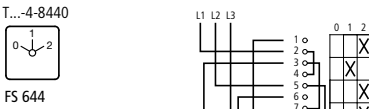
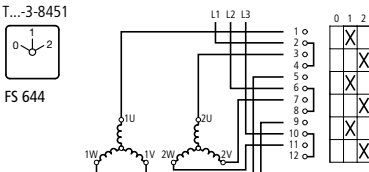
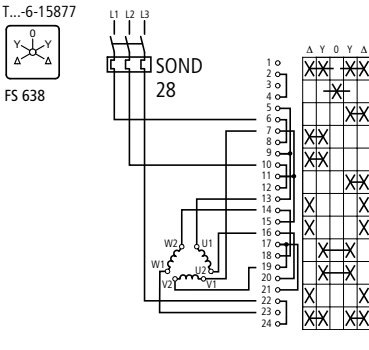
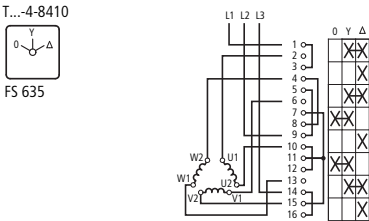
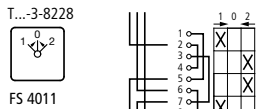
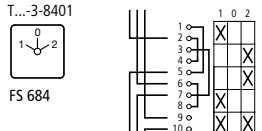
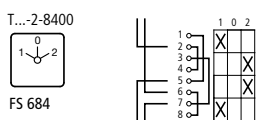
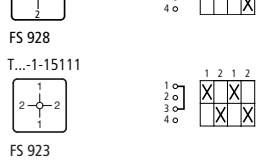
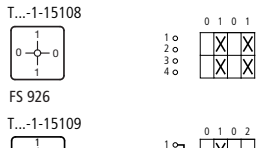
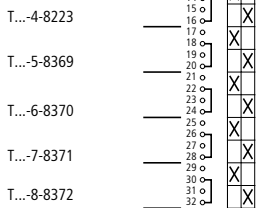
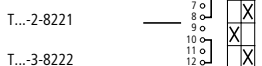
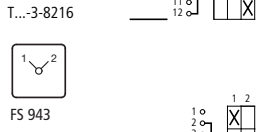
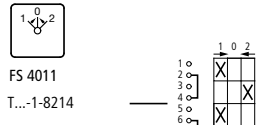
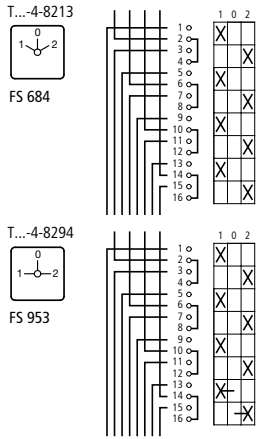
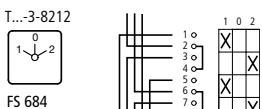
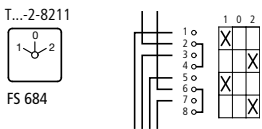
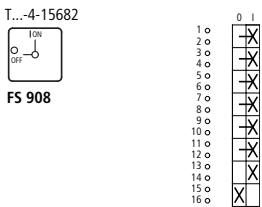
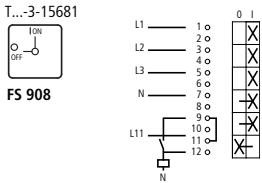
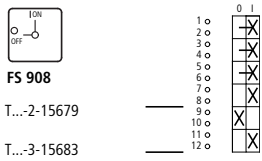
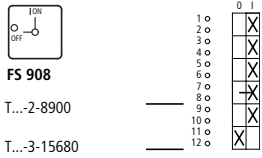
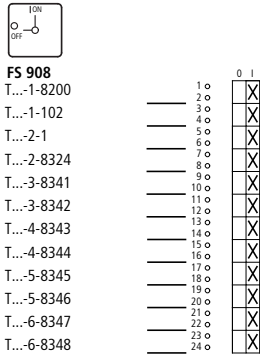

02/13 IL03801008Z