

**SIEMENS**



# SIMATIC

**S7-1500 / ET 200MP**

Módulo de entradas digitales DI 32x24VDC BA (6ES7521-1BL10-0AA0)

Manual de producto

Edición

09/2014

Answers for industry.

# SIEMENS

## SIMATIC

### S7-1500/ET 200MP Módulo de entradas digitales DI 32x24VDC BA (6ES7521-1BL10-0AA0)

Manual de producto

Prólogo

Guía de la documentación

**1**

Descripción del producto

**2**

Conexión

**3**

Espacio de direcciones

**4**

Avisos de diagnóstico

**5**

Datos técnicos

**6**

Croquis acotado

**A**

Open Source Software

**B**

## Notas jurídicas

### Filosofía en la señalización de advertencias y peligros

Este manual contiene las informaciones necesarias para la seguridad personal así como para la prevención de daños materiales. Las informaciones para su seguridad personal están resaltadas con un triángulo de advertencia; las informaciones para evitar únicamente daños materiales no llevan dicho triángulo. De acuerdo al grado de peligro las consignas se representan, de mayor a menor peligro, como sigue.

|   |
|---|
|  <b>PELIGRO</b>                                    |
| Significa que, si no se adoptan las medidas preventivas adecuadas <b>se producirá</b> la muerte, o bien lesiones corporales graves. |

|  |
|--|
|  <b>ADVERTENCIA</b>                                   |
| Significa que, si no se adoptan las medidas preventivas adecuadas <b>puede producirse</b> la muerte o bien lesiones corporales graves. |

|  |
|--|
|  <b>PRECAUCIÓN</b>      |
| Significa que si no se adoptan las medidas preventivas adecuadas, pueden producirse lesiones corporales. |

|   |
|---|
| <b>ATENCIÓN</b>   |
| Significa que si no se adoptan las medidas preventivas adecuadas, pueden producirse daños materiales. |

Si se dan varios niveles de peligro se usa siempre la consigna de seguridad más estricta en cada caso. Si en una consigna de seguridad con triángulo de advertencia se alarma de posibles daños personales, la misma consigna puede contener también una advertencia sobre posibles daños materiales.

### Personal cualificado

El producto/sistema tratado en esta documentación sólo deberá ser manejado o manipulado por **personal cualificado** para la tarea encomendada y observando lo indicado en la documentación correspondiente a la misma, particularmente las consignas de seguridad y advertencias en ella incluidas. Debido a su formación y experiencia, el personal cualificado está en condiciones de reconocer riesgos resultantes del manejo o manipulación de dichos productos/sistemas y de evitar posibles peligros.

### Uso previsto o de los productos de Siemens

Considere lo siguiente:

|  |
|--|
|  <b>ADVERTENCIA</b>   |
| Los productos de Siemens sólo deberán usarse para los casos de aplicación previstos en el catálogo y la documentación técnica asociada. De usarse productos y componentes de terceros, éstos deberán haber sido recomendados u homologados por Siemens. El funcionamiento correcto y seguro de los productos exige que su transporte, almacenamiento, instalación, montaje, manejo y mantenimiento hayan sido realizados de forma correcta. Es preciso respetar las condiciones ambientales permitidas. También deberán seguirse las indicaciones y advertencias que figuran en la documentación asociada. |

### Marcas registradas

Todos los nombres marcados con ® son marcas registradas de Siemens AG. Los restantes nombres y designaciones contenidos en el presente documento pueden ser marcas registradas cuya utilización por terceros para sus propios fines puede violar los derechos de sus titulares.

### Exención de responsabilidad

Hemos comprobado la concordancia del contenido de esta publicación con el hardware y el software descritos. Sin embargo, como es imposible excluir desviaciones, no podemos hacernos responsable de la plena concordancia. El contenido de esta publicación se revisa periódicamente; si es necesario, las posibles las correcciones se incluyen en la siguiente edición.

# Prólogo

## Finalidad de la documentación

El presente manual de producto complementa los siguientes manuales de sistema:

- Sistema de automatización S7-1500
- Sistema de periferia descentralizada ET 200MP

En estos manuales de sistema se describen las funciones que afectan a los sistemas de forma generalizada.

La información contenida en el presente manual de producto y en los manuales de sistema y de funciones permite poner en marcha los sistemas.

## Cambios con respecto a la versión anterior

Con respecto a la versión anterior, el presente manual de producto incluye información más detallada sobre las funciones de los módulos, p. ej., a partir de qué versión de STEP 7 se soporta qué función.

## Convenciones

El término "CPU" se refiere en lo sucesivo tanto a módulos centrales del sistema de automatización S7-1500 como a módulos de interfaz del sistema de periferia descentralizada ET 200MP.

Preste atención también a las notas marcadas del modo siguiente:

---

### Nota

Una nota contiene información importante relativa al producto descrito en la documentación, al manejo de dicho producto o a aquella parte de la documentación a la que debe prestarse especial atención.

---

## Información de seguridad

Siemens suministra productos y soluciones con funciones de seguridad industrial que contribuyen al funcionamiento seguro de instalaciones, soluciones, máquinas, equipos y redes. Dichas funciones son un componente importante de un sistema global de seguridad industrial. En consideración de lo anterior, los productos y soluciones de Siemens son objeto de mejoras continuas. Por ello, le recomendamos que se informe periódicamente sobre las actualizaciones de nuestros productos

Para el funcionamiento seguro de los productos y soluciones de Siemens, es preciso tomar medidas de protección adecuadas (como el concepto de protección de células) e integrar cada componente en un sistema de seguridad industrial integral que incorpore los últimos avances tecnológicos. También deben tenerse en cuenta los productos de otros fabricantes que se estén utilizando. Encontrará más información sobre seguridad industrial en (<http://www.siemens.com/industrialsecurity>).

Si desea mantenerse al día de las actualizaciones de nuestros productos, regístrese para recibir un boletín de noticias específico del producto que desee. Encontrará más información en (<http://support.automation.siemens.com>).

## Software de código abierto

En el firmware del producto descrito se utiliza software de código abierto. El software de código abierto se entrega de forma gratuita. Nos hacemos responsables del Producto descrito, incluido el software de código abierto que contiene, de acuerdo con las condiciones vigentes para el Producto. Declinamos cualquier responsabilidad derivada del uso del software de código abierto más allá del flujo del programa previsto para nuestro producto, así como cualquier responsabilidad derivada de los daños causados por modificaciones del software.

Por motivos legales estamos obligados a publicar las condiciones de licencia y las notas copyright en el texto original. Lea al respecto la información del anexo.

# Índice

|   |  |    |
|---|--|----|
|   | Prólogo .....                                      | 4  |
| 1 | Guía de la documentación .....                     | 7  |
| 2 | Descripción del producto.....                      | 9  |
|   | 2.1 Características .....                          | 9  |
| 3 | Conexión .....                                     | 11 |
|   | 3.1 Esquema eléctrico y esquema de principio ..... | 11 |
| 4 | Espacio de direcciones .....                       | 13 |
|   | 4.1 Espacio de direcciones .....                   | 13 |
| 5 | Avisos de diagnóstico .....                        | 18 |
|   | 5.1 Indicadores de estados y errores.....          | 18 |
| 6 | Datos técnicos .....                               | 20 |
| A | Croquis acotado.....                               | 23 |
| B | Open Source Software.....                          | 25 |

# Guía de la documentación

La documentación del sistema de automatización SIMATIC S7-1500 y del sistema de periferia descentralizada SIMATIC ET 200MP se divide en tres partes. Esta división le permite acceder específicamente al contenido que desee.

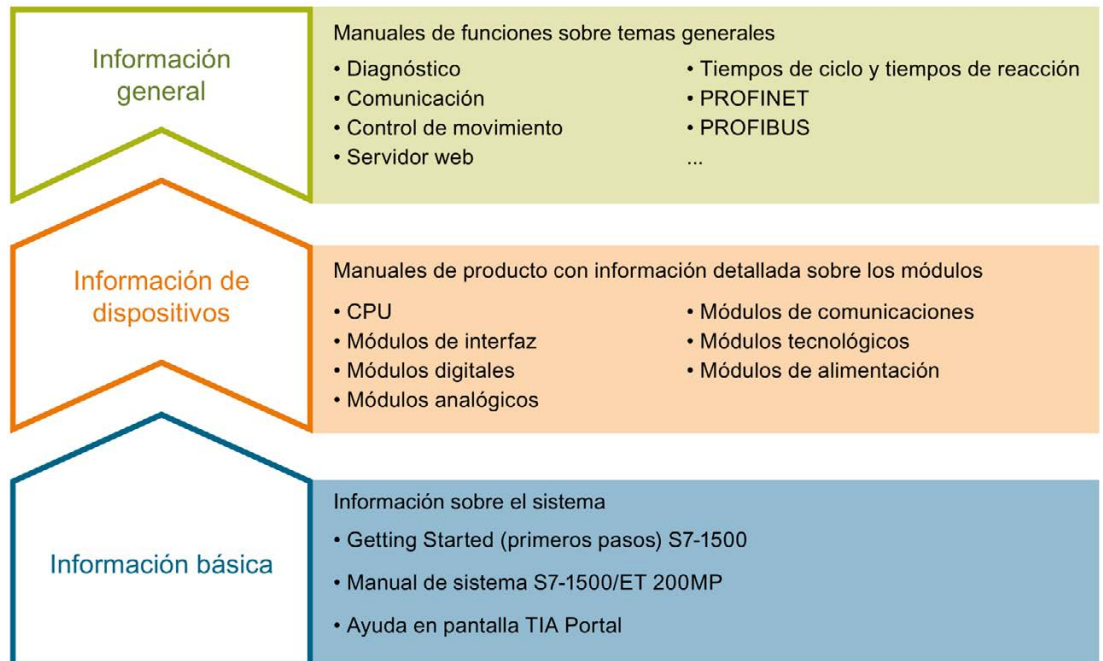

## Información básica

En el manual de sistema y en Getting Started (primeros pasos) se describen detalladamente la configuración, el montaje, el cableado y la puesta en marcha de los sistemas SIMATIC S7-1500 y ET 200MP. La ayuda en pantalla de STEP 7 le presta asistencia a la hora de configurar y programar.

## Información de dispositivos

Los manuales de producto contienen una descripción sintética de la información específica de los módulos, como características, esquemas de conexiones, curvas características o datos técnicos.

## Información general

En los manuales de funciones encontrará descripciones exhaustivas sobre temas generales relacionados con los sistemas SIMATIC S7-1500 y ET 200MP, p. ej. diagnóstico, comunicación, control de movimiento, servidor web.

La documentación se puede descargar gratuitamente de Internet (<http://www.automation.siemens.com/mcms/industrial-automation-systems-simatic/en/manual-overview/tech-doc-controllers/Pages/Default.aspx>).

En la información del producto se documentan los cambios y ampliaciones de los manuales.

## Manual Collection S7-1500/ET 200MP

La Manual Collection contiene la documentación completa del sistema de automatización SIMATIC S7-1500 y del sistema de periferia descentralizada ET 200MP recogida en un archivo.

Encontrará la Manual Collection en Internet (<http://support.automation.siemens.com/WW/view/es/86140384>).

## My Documentation Manager

Con My Documentation Manager se combinan manuales enteros o partes de ellos para elaborar un manual propio. Este manual se puede exportar como archivo PDF o en un formato editable.

Encontrará My Documentation Manager en Internet (<http://support.automation.siemens.com/WW/view/es/38715968>).

## Aplicaciones & Tools

Aplicaciones & Tools le proporciona herramientas y ejemplos para resolver tareas de automatización. Las soluciones se representan como combinación de varios componentes del sistema; se evita centrarse en productos concretos.

Encontrará Aplicaciones & Tools en Internet (<http://support.automation.siemens.com/WW/view/es/20208582>).

## Cesta de Compra CAx

La Cesta de Compra CAx permite acceder a datos de producto actuales para el sistema CAx o CAe.

Con solo unos clics configurará su propio paquete para descargar.

Puede elegir lo siguiente:

- Imágenes de producto, croquis acotados 2D, modelos 3D, esquemas de conexiones, archivos de macros EPLAN
- Manuales, curvas características, instrucciones de uso, certificados
- Datos característicos de productos

Encontrará la Cesta de Compra CAx en Internet (<http://support.automation.siemens.com/WW/view/es/42455541>).



## Descripción del producto

### 2.1 Características

Referencia:

6ES7521-1BL10-0AA0

Vista del módulo



Figura 2-1 Vista del módulo DI 32x24VDC BA

## Características

El módulo tiene las siguientes características técnicas:

- 32 entradas digitales, aisladas en grupos de 16
- Tensión nominal de entrada 24 V DC
- Adecuado para interruptores y detectores de proximidad a 2, 3 o 4 hilos
- Hardware compatible con el módulo de entradas digitales DI 16x24VDC BA(6ES7521-1BH10-0AA0)

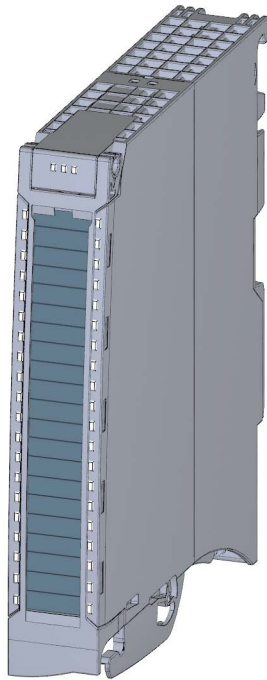
El módulo soporta las siguientes funciones:

Tabla 2- 1 Dependencias de la versión de las funciones del módulo

| Función  | Versión de firmware del módulo | Software de configuración                    |  |
|--|--------------------------------|--|--|
|  |                                | STEP 7 (TIA Portal)                          | Archivo GSD en STEP 7 (TIA Portal) a partir de V12 o STEP 7 a partir de V5.5 SP3 |
| Actualización del firmware                             | a partir de V1.0.0             | a partir de V13                              | X  |
| Datos de identificación I&M0 a I&M3                    | a partir de V1.0.0             | a partir de V13                              | X  |
| Shared Input interna del módulo (MSI)                  | a partir de V1.0.0             | a partir de V13, Update 3 (solo PROFINET IO) | X (solo PROFINET IO)   |
| Submódulos configurables/submódulos para Shared Device | a partir de V1.0.0             | a partir de V13, Update 3 (solo PROFINET IO) | X (solo PROFINET IO)   |

El módulo puede configurarse con STEP 7 (TIA Portal) y con un archivo GSD.

## Accesorios

Los siguientes accesorios se suministran con el módulo y también pueden pedirse como repuesto:

- Conector frontal (bornes push-in), incluidas las bridas
- Tiras rotulables
- Conectores en U
- Puerta frontal universal

Encontrará más información acerca de los accesorios en los manuales de sistema Sistema de automatización S7-1500 (<http://support.automation.siemens.com/WW/view/es/59191792>) y Sistema de periferia descentralizada ET 200MP (<http://support.automation.siemens.com/WW/view/es/59193214>).

## Conexión

### 3.1 Esquema eléctrico y esquema de principio

En el presente capítulo encontrará el esquema de principio del módulo y diferentes opciones de conexión.

Encontrará información sobre cómo cablear el conector frontal, apantallar el cable, etc. en el manual de sistema Sistema de automatización S7-1500 (<http://support.automation.siemens.com/WW/view/es/59191792>) y en el manual de sistema Sistema de periferia descentralizada ET 200MP (<http://support.automation.siemens.com/WW/view/es/59193214>), capítulo Conexión.

**Abreviaturas utilizadas**

Significado de las abreviaturas utilizadas en la figura siguiente:

- M                      Conexión a tierra
- CHx                    Canal o indicador de estado del canal

La siguiente figura muestra la forma de conectar el módulo y la asignación de los canales a las direcciones (desde byte de entrada a hasta byte de entrada d).

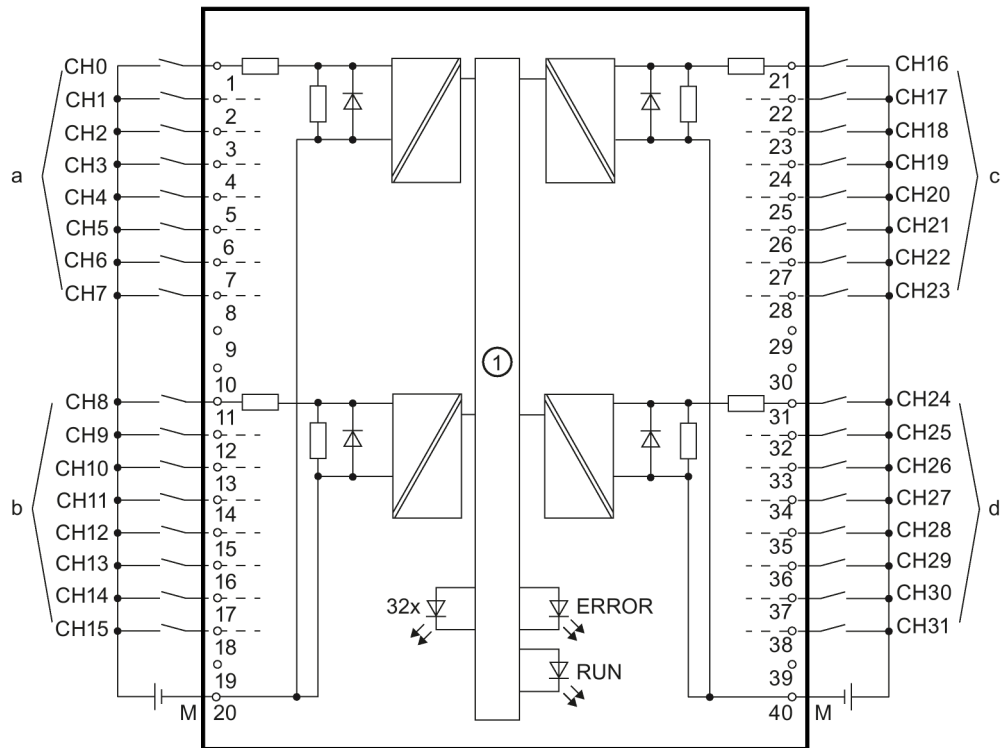

① Interfaz con el bus de fondo

Figura 3-1 Esquema de principio y asignación de conexiones

## Espacio de direcciones

### 4.1 Espacio de direcciones

En STEP 7, el módulo puede configurarse de diferentes maneras. En función de la configuración se asignan direcciones adicionales/diferentes en la memoria imagen de proceso de las entradas.

#### Opciones de configuración de DI 32x24VDC BA

El módulo puede configurarse con STEP 7 (TIA Portal) o con un archivo GSD.

Si se configura el módulo a través de un archivo GSD, encontrará las configuraciones bajo diversos nombres abreviados/nombres de módulo.

Son posibles las configuraciones siguientes:

Tabla 4- 1 Opciones de configuración

| Configuración   | Nombre abreviado/<br>nombre del módulo en el<br>archivo GSD | Software de configuración, p. ej., con STEP 7<br>(TIA Portal)  |   |
|---|---|--|---|
|   |   | Integrado en el catálogo<br>de hardware<br>STEP 7 (TIA Portal) | Archivo GSD en<br>STEP 7 (TIA Portal) a<br>partir de V12 o STEP 7<br>a partir de V5.5 SP3 |
| 1 x 32 canales sin información de calidad   | DI 32x24VDC BA  | a partir de V13  | X   |
| 4 x 8 canales sin información de calidad  | DI 32x24VDC BA S  | a partir de V13, Update 3<br>(solo PROFINET IO)                | X<br>(solo PROFINET IO)   |
| 1 x 32 canales con información de calidad para Shared Input interno del módulo con hasta 4 submódulos | DI 32x24VDC BA MSI  | a partir de V13, Update 3<br>(solo PROFINET IO)                | X<br>(solo PROFINET IO)   |

**Espacio de direcciones en la configuración como DI 32x24VDC BA de 1 x 32 canales**

La figura siguiente muestra la asignación del espacio de direcciones en la configuración como módulo de 1 x 32 canales. La dirección inicial del módulo puede asignarse libremente. Las direcciones de los canales se derivan de la dirección inicial.

Las letras "a" a "d" están serigrafiadas en el módulo. "EB a" significa, p. ej., dirección inicial del módulo, byte de entrada "a".

Asignación en la memoria imagen de proceso de las entradas (MIPE)



Figura 4-1 Espacio de direcciones en la configuración como DI 32x24VDC BA de 1 x 32 canales

**Espacio de direcciones en la configuración como DI 32x24VDC BA S de 4 x 8 canales**

En la configuración como módulo de 4 x 8 canales, los canales del módulo se reparten entre varios submódulos. Estos submódulos pueden asignarse a diferentes controladores IO si el módulo se utiliza en un Shared Device.

A diferencia de la configuración como módulo de 1 x 32 canales, cada uno de los cuatro submódulos tiene una dirección inicial de libre asignación.

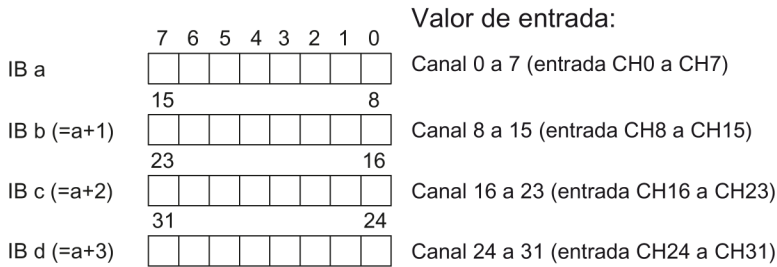
Asignación en la memoria imagen de proceso de las entradas (MIPE)



Figura 4-2 Espacio de direcciones en la configuración como DI 32x24VDC BA S de 4 x 8 canales

## **Espacio de direcciones en la configuración como DI 32x24VDC BA MSide 1 x 32 canales**

En la configuración del módulo de 1 x 32 canales (Shared Input interno del módulo, MSI), los canales 0 a 31 del módulo se copian en hasta 4 submódulos. Por lo tanto, los canales 0 a 31 tienen valores de entrada idénticos en los distintos submódulos. Estos submódulos pueden asignarse a hasta cuatro controladores IO si el módulo se utiliza en un Shared Device. Cada controlador IO puede tener acceso de lectura a los mismos canales.

El número de submódulos utilizables varía en función del módulo de interfaz utilizado. Lea las indicaciones del manual de producto del respectivo módulo de interfaz.

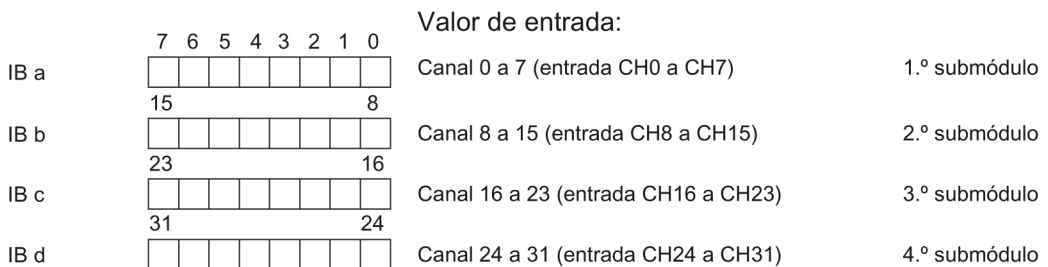
### **Información de calidad (Quality Information, QI)**

El significado de la información de calidad depende del submódulo en cuestión.

En el submódulo 1 (= submódulo base), la información de calidad es irrelevante.

En los submódulos 2 a 4 (= submódulos MSI), la información de calidad 0 indica que el valor es erróneo o que el submódulo base todavía no está configurado (no listo para funcionar).

4.1 Espacio de direcciones

La siguiente figura muestra la asignación del espacio de direcciones con los submódulos 1 y 2.

Asignación en la memoria imagen de proceso de las entradas (MIPE) para los submódulos 1 y 2

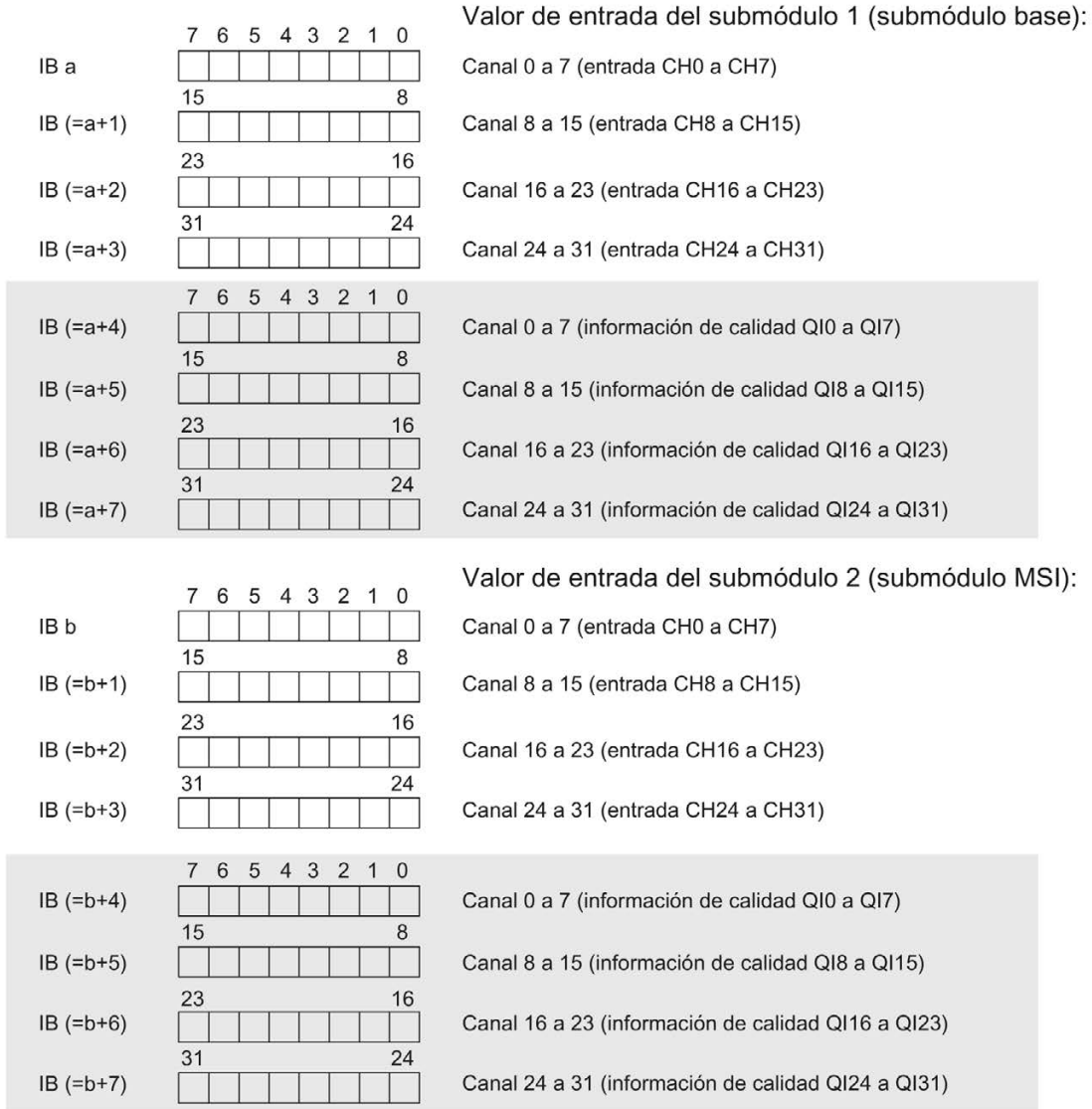

0 = el valor leído en el canal es incorrecto

Figura 4-3 Espacio de direcciones en la configuración como DI 32x24VDC BA MSI de 1 x 32 canales con información de calidad



La siguiente figura muestra la asignación del espacio de direcciones con los submódulos 3 y 4.

Asignación en la memoria imagen de proceso de las entradas (MIPE) para los submódulos 3 y 4



Figura 4-4 Espacio de direcciones en la configuración como DI 32x24VDC BA MSI de 1 x 32 canales con información de calidad

## Avisos de diagnóstico

El módulo no dispone de diagnóstico parametrizable. Los avisos de diagnóstico no pueden emitirse, p. ej., con STEP 7 (TIA Portal).

### 5.1 Indicadores de estados y errores

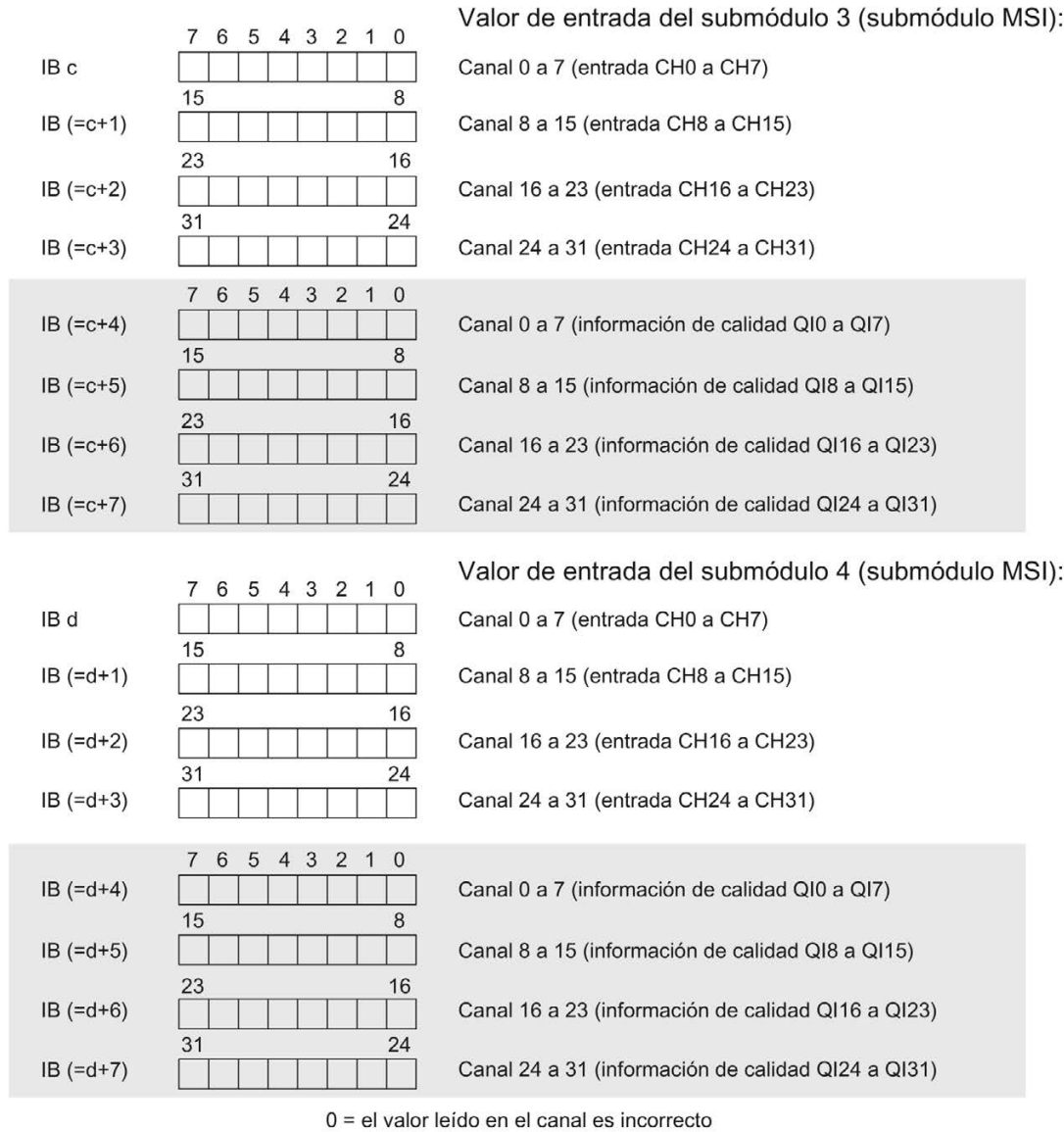
#### Indicadores LED

La siguiente figura muestra los indicadores LED (indicadores de estados y errores) de DI 32x24VDC BA.









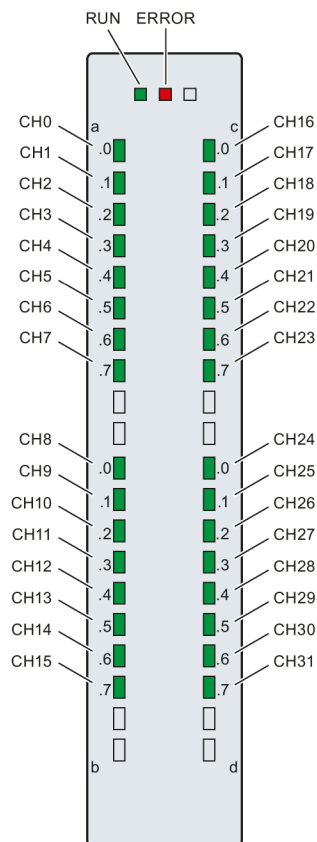

Figura 5-1 LED del módulo DI 32x24VDC BA

## Significado de los indicadores LED

En las tablas siguientes se explica el significado de los indicadores de estados y errores.



### LED RUN/ERROR

Tabla 5- 1 Indicadores de estados y errores RUN/ERROR

| LED  |  | Significado                                 | Solución   |
|--|--|---|--|
| RUN  | ERROR  |   |  |
|  apagado    |  apagado    | Tensión muy baja o nula en el bus de fondo. | <ul style="list-style-type: none"> <li>• Conecte la CPU y/o los módulos de alimentación del sistema.</li> <li>• Compruebe que estén enchufados los conectores U.</li> <li>• Compruebe si hay demasiados módulos enchufados.</li> </ul> |
|  parpadea   |  apagado    | El módulo arranca.                          | ---  |
|  encendido  |  apagado    | El módulo está listo para el servicio.      |  |
|  parpadea |  parpadea | Hardware defectuoso.                        | Sustituya el módulo.   |

### LED CHx

Tabla 5- 2 Indicador de estado CHx

| LED CHx   | Significado                        | Solución |
|---|------------------------------------|----------|
|  apagado   | 0 = Estado de la señal de entrada. | ---      |
|  encendido | 1 = Estado de la señal de entrada. | ---      |

## Datos técnicos

### Datos técnicos de DI 32x24VDC BA

|  | 6ES7521-1BL10-0AA0  |
|--|---|
| Nombre del producto                                    | DI 32x24VDC BA  |
| <b>Información general</b>                             |   |
| Versión de HW  | E01   |
| Versión de firmware                                    | V1.0.0  |
| <b>Función del producto</b>                            |   |
| Datos I&M  | Sí; I&M0 a I&M3   |
| <b>Ingeniería con</b>                                  |   |
| STEP 7 TIA Portal configurable/integrado desde versión | V13/V13   |
| STEP 7 configurable/integrado desde versión            | V5.5 SP3/-  |
| <b>Modo de operación</b>                               |   |
| MSI  | Sí  |
| <b>Tensión de alimentación</b>                         |   |
| Tipo de tensión de alimentación                        | DC  |
| Valor nominal (DC)                                     | 24 V  |
| Rango admisible, límite inferior (DC)                  | 20,4 V  |
| Rango admisible, límite superior (DC)                  | 28,8 V  |
| <b>Potencia</b>  |   |
| Potencia tomada del bus de fondo                       | 1,05 W  |
| <b>Potencia disipada</b>                               |   |
| Potencia disipada, típ.                                | 3 W   |
| <b>Entradas digitales</b>                              |   |
| Número de entradas                                     | 32  |
| Fuente/sumidero  | Sumidero  |
| Característica de entrada según IEC 61131, tipo 3      | Sí  |
| <b>Tensión de entrada</b>                              |   |
| Valor nominal, DC                                      | 24  |
| Para señal "0"   | -30 a +5 V  |
| Para señal "1"   | 11 a 30 V   |
| Tensión admisible a la entrada, mín.                   | -30 V; -3V permanente; -30V brevemente protección contra inversión de polaridad |
| Tensión admisible a la entrada, máx.                   | 30 V  |
| <b>Intensidad de entrada</b>                           |   |
| Para señal "1", típ.                                   | 2,7 mA  |

| <b>6ES7521-1BL10-0AA0</b>                                    |               |
|--|---------------|
| <b>Retardo a la entrada (con tensión nominal de entrada)</b> |               |
| Para entradas estándar                                       |               |
| • parametrizable   | No            |
| • En transición "0" a "1", mín.                              | 3 ms          |
| • En transición "0" a "1", máx.                              | 4 ms          |
| • En transición "1" a "0", mín.                              | 3 ms          |
| • En transición "1" a "0", máx.                              | 4 ms          |
| Para entradas de alarmas                                     |               |
| • parametrizable   | No            |
| <b>Longitud de cable</b>                                     |               |
| Longitud de cable apantallado, máx.                          | 1000 m        |
| Longitud de cable no apantallado, máx.                       | 600 m         |
| <b>Sensores</b>  |               |
| <b>Sensores conectables</b>                                  |               |
| Sensor a 2 hilos   | Sí            |
| • Intensidad permitida en reposo (sensor a 2 hilos), máx.    | 1,5 mA        |
| <b>Modo isócrono</b>   |               |
| Modo isócrono (aplicación sincronizada hasta el borne)       | No            |
| <b>Alarmas/diagnósticos/información de estado</b>            |               |
| <b>Alarmas</b>   |               |
| Alarma de diagnóstico  | No            |
| Alarma de proceso  | No            |
| <b>Avisos de diagnóstico</b>                                 |               |
| Diagnóstico  | No            |
| Vigilancia de la tensión de alimentación                     | No            |
| Rotura de hilo   | No            |
| Cortocircuito  | No            |
| Actuación fusible  | No            |
| <b>LED de diagnóstico</b>                                    |               |
| LED RUN  | Sí; LED verde |
| LED ERROR  | Sí, LED rojo  |
| LED MAINT  | No            |
| Vigilancia de la tensión de alimentación                     | No            |
| Indicador de estado del canal                                | Sí; LED verde |
| Para diagnóstico de canal                                    | No            |
| Para diagnóstico de módulos                                  | No            |

| <b>6ES7521-1BL10-0AA0</b>                             |  |
|---|--|
| <b>Aislamiento galvánico</b>                          |  |
| <b>Aislamiento galvánico de canales</b>               |  |
| Entre los canales                                     | No   |
| Entre los canales, en grupos de                       | 16   |
| Entre los canales y el bus de fondo                   | Sí   |
| Entre los canales y la alimentación de la electrónica | No   |
| <b>Diferencia de potencial admisible</b>              |  |
| Entre circuitos diferentes                            | 75 V DC/60 V AC (aislamiento básico)                       |
| <b>Aislamiento</b>                                    |  |
| Aislamiento ensayado con                              | 707 V DC (ensayo de tipo)                                  |
| <b>Operación descentralizada</b>                      |  |
| Arranque optimizado                                   | Sí   |
| <b>Dimensiones</b>                                    |  |
| Anchura   | 25 mm  |
| Altura  | 147 mm   |
| Profundidad   | 129 mm   |
| <b>Pesos</b>  |  |
| Peso, aprox.  | 260 g  |
| <b>Otros</b>  |  |
| Nota:   | El suministro incluye conector frontal push-in de 40 polos |

# Croquis acotado

# A

Este anexo incluye el croquis acotado del módulo montado en un perfil soporte, así como un croquis acotado con tapa frontal abierta. Las dimensiones deben tenerse en cuenta al montar el módulo en armarios, salas de distribución, etc.



Figura A-1 Croquis acotado del módulo DI 32x24VDC BA



Figura A-2 Croquis acotado del módulo DI 32x24VDC BA, vista lateral con tapa frontal abierta

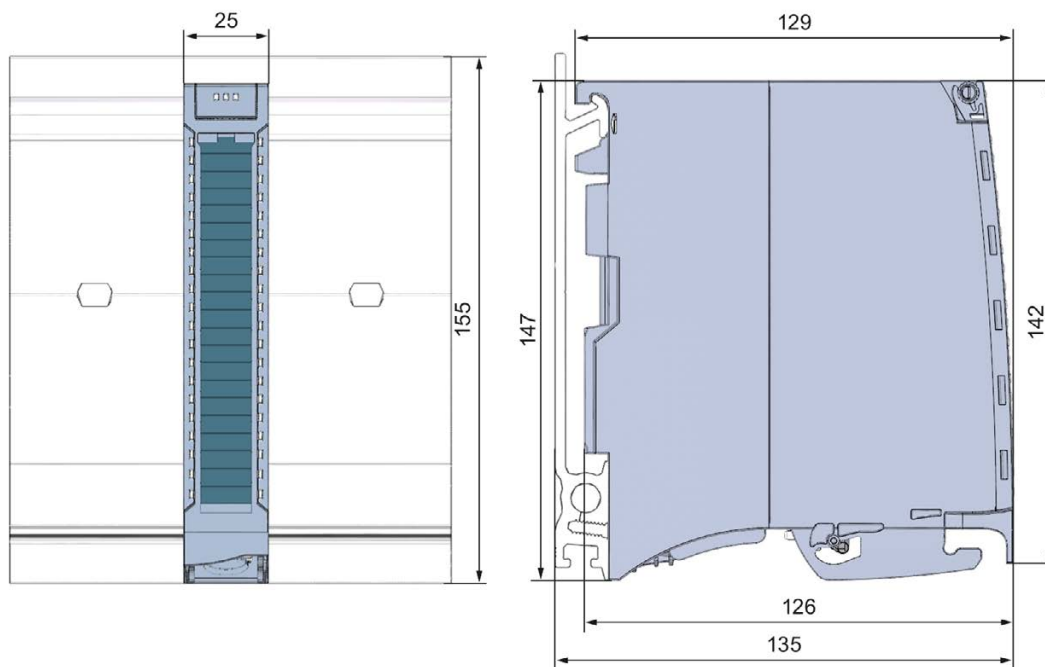

# Open Source Software

# B

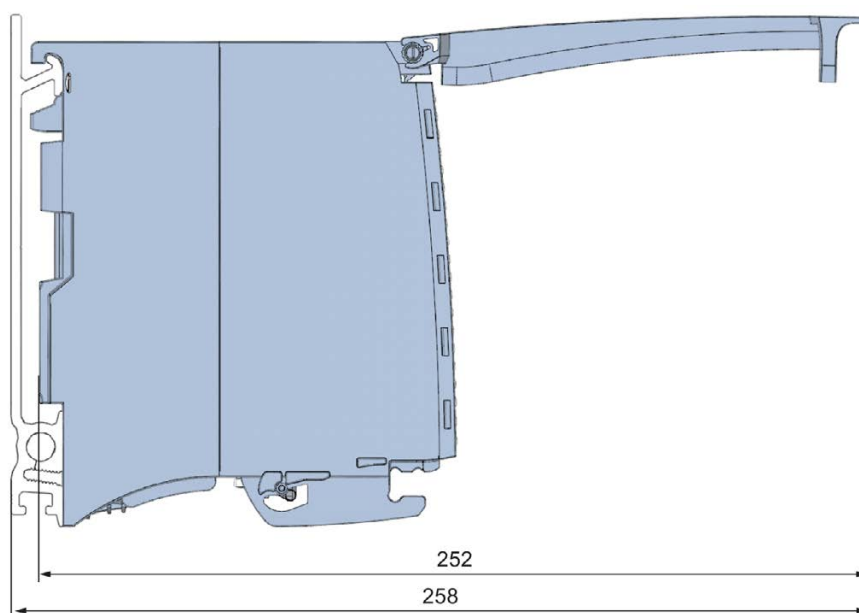
**A los revendedores: para prevenir violaciones de la licencia tanto por parte del revendedor como del comprador, es obligatorio entregar al comprador estas indicaciones y términos de licencia.**

## **Términos de licencia y exclusión de responsabilidades del software de código abierto y demás software de licencia**

En los "módulos digitales, módulos analógicos, módulos tecnológicos, módulos de comunicación y módulos de potencia de SIMATIC S7-1500, ET 200MP", Copyright Siemens AG, 2013 - 2014 (en adelante, "producto"), se aplica el software de código abierto, ya sea sin modificar o modificado por nosotros, y el software de licencia expuestos más abajo.

### **Responsabilidad por el software de código abierto**

El software de código abierto se entrega de forma gratuita. Nosotros nos responsabilizamos del producto, incluido el software de código abierto que contenga, conforme a los términos de licencia vigentes para el producto. Queda excluida toda responsabilidad por el uso del software de código abierto más allá de la ejecución del programa prevista por nosotros para el producto, así como cualquier responsabilidad relacionada con fallos que se puedan derivar de una modificación del software de código abierto.

Igualmente queda excluido cualquier soporte técnico del producto en aquellos casos en los que este haya sido modificado.

**Por favor, lea atentamente los términos de licencia y los derechos de copyright del software de código abierto y demás software de licencia:**

| Component                             | Open Source Software [Yes/No] | Acknowledgements | Copyright Information / File  |
|---------------------------------------|-------------------------------|------------------|---|
| Dinkumware C/C++ Library - 5.01       | NO                            |                  | LICENSE AND COPYRIGHT INFORMATION FOR COMPONENT DINKUMWARE C/C++ LIBRARY - 5.01       |
| GNU GCC libgcc - 4.3.2                | YES                           |                  | LICENSE AND COPYRIGHT INFORMATION FOR COMPONENT GNU GCC LIBGCC - 4.3.2                |
| GNU GCC libstdc++ / libsupc++ - 4.3.2 | YES                           |                  | LICENSE AND COPYRIGHT INFORMATION FOR COMPONENT GNU GCC LIBSTDC++ / LIBSUPC++ - 4.3.2 |

LICENSE CONDITIONS AND COPYRIGHT NOTICES

Commercial Software: Dinkumware C/C++ Library - 5.01  
Enclosed you'll find the license conditions and copyright notices applicable for Commercial Software Dinkumware C/C++ Library - 5.01

License conditions:

Copyright (c) 1991-1999 Unicode, Inc. All Rights reserved.  
This file is provided as-is by Unicode, Inc. (The Unicode Consortium). No claims are made as to fitness for any particular purpose. No warranties of any kind are expressed or implied. The recipient agrees to determine applicability of information provided. If this file has been provided on optical media by Unicode, Inc., the sole remedy for any claim will be exchange of defective media within 90 days of receipt. Unicode, Inc. hereby grants the right to freely use the information supplied in this file in the creation of products supporting the Unicode Standard, and to make copies of this file in any form for internal or external distribution as long as this notice remains attached.

© Copyright William E. Kempf 2001 Permission to use, copy, modify, distribute and sell this software and its documentation for any purpose is hereby granted without fee, provided that the above copyright notice appear in all copies and that both that copyright notice and this permission notice appear in supporting documentation. William E. Kempf makes no representations about the suitability of this software for any purpose. It is provided "as is" without express or implied warranty.

Copyright © 1994 Hewlett-Packard Company Permission to use, copy, modify, distribute and sell this software and its documentation for any purpose is hereby granted without fee, provided that the above copyright notice appear in all copies and that both that copyright notice and this permission notice appear in supporting documentation. Hewlett-Packard Company makes no representations about the suitability of this software for any purpose. It is provided "as is" without express or implied warranty.

Copyrights:

Copyright 1992 - 2006 by p.j. plauger and jim brodie. all rights reserved.

Copyright 1992-2006 by p.j. plauger. all rights reserved.ip

Copyright 1992-2006 by p.j. plauger. portions derived from work copyright 1994 by hewlettpackard company. all rights reserved

Copyright 1992-2006 by dinkumware, ltd. all rights reserved

Copyright 1992-2006 by dinkumware, ltd. portions derived from work copyright 2001 by william e. kempf. all rights reserved

Copyright 1994 hewlettpackard company

Copyright 1994 by hewlettpackard company

Copyright william e. kempf 2001

Copyright 1989-2006 by p.j. plauger. all rights reserved

Copyright (c) by p.j. plauger. all rights reserved.

Copyright (c) by dinkumware, ltd. all rights reserved.

Copyright (c) unicode, inc. all rights reserved.

(c) Copyright william e. kempf 2001

Copyright (c) hewlettpackard company

Copyright (c) by p.j. plauger. all rights reserved.

Copyright 2006 by dinkumware, ltd.

copyright (c) by p.j. plauger, licensed by dinkumware, ltd. all rights reserved.

the dinkum cec++ library reference is copyright (c) by p.j. plauger. this code is protected by copyright. all rights reserved.

the dinkum cc++ library reference is copyright (c) by p.j. plauger. this code is protected by copyright. all rights reserved.

dinkum compleat library, vc++ package (vc++ compilers only) the dinkum compleat library and the dinkum compleat library reference are copyright (c) by p.j. plauger. all rights reserved.

LICENSE CONDITIONS AND COPYRIGHT NOTICES

Open Source Software: GNU GCC libgcc - 4.3.2  
Enclosed you'll find the license conditions and copyright notices applicable for Open Source Software GNU GCC libgcc - 4.3.2

License conditions:

GCC is free software; you can redistribute it and/or modify it under the terms of the GNU General Public License as published by the Free Software Foundation; either version 2, or (at your option) any later version.

In addition to the permissions in the GNU General Public License, the Free Software Foundation gives you unlimited permission to link the compiled version of this file into combinations with other programs, and to distribute those combinations without any restriction coming from the use of this file. (The General Public License restrictions do apply in other respects; for example, they cover modification of the file, and distribution when not linked into a combine executable.)

GCC is distributed in the hope that it will be useful, but WITHOUT ANY WARRANTY; without even the implied warranty of MERCHANTABILITY or FITNESS FOR A PARTICULAR PURPOSE. See the GNU General Public License for more details

You should have received a copy of the GNU General Public License along with GCC; see the file COPYING. If not, write to the Free Software Foundation, 51 Franklin Street, Fifth Floor, Boston, MA

---  
GNU GENERAL PUBLIC LICENSE  
Version 2, June 1991

Copyright (C) 1989, 1991 Free Software Foundation, Inc.

59 Temple Place, Suite 330, Boston, MA 02111-1307 USA

Everyone is permitted to copy and distribute verbatim copies of this license document, but changing it is not allowed.

Preamble

The licenses for most software are designed to take away your freedom to share and change it. By contrast, the GNU General Public License is intended to guarantee your freedom to share and change free software--to make sure the software is free for all its users. This General Public License applies to most of the Free Software Foundation's software and to any other program whose authors commit to using it. (Some other Free Software Foundation software is covered by the GNU Library General Public License instead.) You can apply it to your programs, too.

When we speak of free software, we are referring to freedom, not price. Our General Public Licenses are designed to make sure that you have the freedom to distribute copies of free software (and charge for this service if you wish), that you receive source code or can get it if you want it, that you can change the software or use pieces of it in new free programs; and that you know you can do these things.

To protect your rights, we need to make restrictions that forbid anyone to deny you these rights or to ask you to surrender the rights. These restrictions translate to certain responsibilities for you if you distribute copies of the software, or if you modify it.

For example, if you distribute copies of such a program, whether gratis or for a fee, you must give the recipients all the rights that you have. You must make sure that they, too, receive or can get the source code. And you must show them these terms so they know their rights.

We protect your rights with two steps: (1) copyright the software, and (2) offer you this license which gives you legal permission to copy, distribute and/or modify the software.

Also, for each author's protection and ours, we want to make certain that everyone understands that there is no warranty for this free software. If the software is modified by someone else and passed on, we want its recipients to know that what they have is not the original, so that any problems introduced by others will not reflect on the original authors' reputations.

Finally, any free program is threatened constantly by software patents. We wish to avoid the danger that redistributors of a free program will individually obtain patent licenses, in effect making the program proprietary. To prevent this, we have made it clear that any patent must be licensed for everyone's free use or not licensed at all.

The precise terms and conditions for copying, distribution and modification follow.

#### GNU GENERAL PUBLIC LICENSE TERMS AND CONDITIONS FOR COPYING, DISTRIBUTION AND MODIFICATION

0. This License applies to any program or other work which contains a notice placed by the copyright holder saying it may be distributed under the terms of this General Public License. The "Program", below, refers to any such program or work, and a "work based on the Program" means either the Program or any derivative work under copyright law: that is to say, a work containing the Program or a portion of it, either verbatim or with modifications and/or translated into another language. (Hereinafter, translation is included without limitation in the term "modification".) Each licensee is addressed as "you".

Activities other than copying, distribution and modification are not covered by this License; they are outside its scope. The act of running the Program is not restricted, and the output from the Program is covered only if its contents constitute a work based on the Program (independent of having been made by running the Program). Whether that is true depends on what the Program does.

1. You may copy and distribute verbatim copies of the Program's source code as you receive it, in any medium, provided that you conspicuously and appropriately publish on each copy an appropriate copyright notice and disclaimer of warranty; keep intact all the notices that refer to this License and to the absence of any warranty; and give any other recipients of the Program a copy of this License along with the Program.

You may charge a fee for the physical act of transferring a copy, and you may at your option offer warranty protection in exchange for a fee.

2. You may modify your copy or copies of the Program or any portion of it, thus forming a work based on the Program, and copy and distribute such modifications or work under the terms of Section 1 above, provided that you also meet all of these conditions:

a) You must cause the modified files to carry prominent notices stating that you changed the files and the date of any change.

b) You must cause any work that you distribute or publish, that in whole or in part contains or is derived from the Program or any part thereof, to be licensed as a whole at no charge to all third parties under the terms of this License.

c) If the modified program normally reads commands interactively when run, you must cause it, when started running for such interactive use in the most ordinary way, to print or display an announcement including an appropriate copyright notice and a notice that there is no warranty (or else, saying that you provide a warranty) and that users may redistribute the program under these conditions, and telling the user how to view a copy of this License. (Exception: if the Program itself is interactive but does not normally print such an announcement, your work based on the Program is not required to print an announcement.)

These requirements apply to the modified work as a whole. If identifiable sections of that work are not derived from the Program, and can be reasonably considered independent and separate works in themselves, then this License, and its terms, do not apply to those sections when you distribute them as separate works. But when you distribute the same sections as part of a whole which is a work based on the Program, the distribution of the whole must be on the terms of this License, whose permissions for other licensees extend to the entire whole, and thus to each and every part regardless of who wrote it.

Thus, it is not the intent of this section to claim rights or contest your rights to work written entirely by you; rather, the intent is to exercise the right to control the distribution of derivative or collective works based on the Program.

In addition, mere aggregation of another work not based on the Program with the Program (or with a work based on the Program) on a volume of a storage or distribution medium does not bring the other work under the scope of this License.

3. You may copy and distribute the Program (or a work based on it, under Section 2) in object code or executable form under the terms of Sections 1 and 2 above provided that you also do one of the following:

a) Accompany it with the complete corresponding machine-readable source code, which must be distributed under the terms of Sections 1 and 2 above on a medium customarily used for software interchange; or,

b) Accompany it with a written offer, valid for at least three years, to give any third party, for a charge no more than your cost of physically performing source distribution, a complete machine-readable copy of the corresponding source code, to be distributed under the terms of Sections 1 and 2 above on a medium customarily used for software interchange; or,

c) Accompany it with the information you received as to the offer to distribute corresponding source code. (This alternative is allowed only for noncommercial distribution and only if you received the program in object code or executable form with such an offer, in accord with Subsection b above.)

The source code for a work means the preferred form of the work for making modifications to it. For an executable work, complete source code means all the source code for all modules it contains, plus any associated interface definition files, plus the scripts used to control compilation and installation of the executable. However, as a special exception, the source code distributed need not include anything that is normally distributed (in either source or binary form) with the major components (compiler, kernel, and so on) of the operating system on which the executable runs, unless that component itself accompanies the executable.

If distribution of executable or object code is made by offering access to copy from a designated place, then offering equivalent access to copy the source code from the same place counts as distribution of the source code, even though third parties are not compelled to copy the source along with the object code.

4. You may not copy, modify, sublicense, or distribute the Program except as expressly provided under this License. Any attempt otherwise to copy, modify, sublicense or distribute the Program is void, and will automatically terminate your rights under this License. However, parties who have received copies, or rights, from you under this License will not have their licenses terminated so long as such parties remain in full compliance.

5. You are not required to accept this License, since you have not signed it. However, nothing else grants you permission to modify or distribute the Program or its derivative works. These actions are prohibited by law if you do not accept this License. Therefore, by modifying or distributing the Program (or any work based on the Program), you indicate your acceptance of this License to do so, and all its terms and conditions for copying, distributing or modifying the Program or works based on it.

6. Each time you redistribute the Program (or any work based on the Program), the recipient automatically receives a license from the original licensor to copy, distribute or modify the Program subject to these terms and conditions. You may not impose any further restrictions on the recipients' exercise of the rights granted herein. You are not responsible for enforcing compliance by third parties to this License.

7. If, as a consequence of a court judgment or allegation of patent infringement or for any other reason (not limited to patent issues), conditions are imposed on you (whether by court order, agreement or otherwise) that contradict the conditions of this License, they do not excuse you from the conditions of this License. If you cannot distribute so as to satisfy simultaneously your obligations under this License and any other pertinent obligations, then as a consequence you may not distribute the Program at all. For example, if a patent license would not permit royalty-free redistribution of the Program by all those who receive copies directly or indirectly through you, then the only way you could satisfy both it and this License would be to refrain entirely from distribution of the Program.

If any portion of this section is held invalid or unenforceable under any particular circumstance, the balance of the section is intended to apply and the section as a whole is intended to apply in other circumstances.

It is not the purpose of this section to induce you to infringe any patents or other property right claims or to contest validity of any such claims; this section has the sole purpose of protecting the integrity of the free software distribution system, which is implemented by public license practices.

Many people have made generous contributions to the wide range of software distributed through that system in reliance on consistent application of that system; it is up to the author/donor to decide if he or she is willing to distribute software through any other system and a licensee cannot impose that choice.

This section is intended to make thoroughly clear what is believed to be a consequence of the rest of this License.

8. If the distribution and/or use of the Program is restricted in certain countries either by patents or by copyrighted interfaces, the original copyright holder who places the Program under this License may add an explicit geographical distribution limitation excluding those countries, so that distribution is permitted only in or among countries not thus excluded. In such case, this License incorporates the limitation as if written in the body of this License.

9. The Free Software Foundation may publish revised and/or new versions of the General Public License from time to time. Such new versions will be similar in spirit to the present version, but may differ in detail to address new problems or concerns.

Each version is given a distinguishing version number. If the Program specifies a version number of this License which applies to it and "any later version", you have the option of following the terms and conditions either of that version or of any later version published by the Free Software Foundation. If the Program does not specify a version number of this License, you may choose any version ever published by the Free Software Foundation.

10. If you wish to incorporate parts of the Program into other free programs whose distribution conditions are different, write to the author to ask for permission. For software which is copyrighted by the Free Software Foundation, write to the Free Software Foundation; we sometimes make exceptions for this. Our decision will be guided by the two goals of preserving the free status of all derivatives of our free software and of promoting the sharing and reuse of software generally.

NO WARRANTY

11. BECAUSE THE PROGRAM IS LICENSED FREE OF CHARGE, THERE IS NO WARRANTY FOR THE PROGRAM, TO THE EXTENT PERMITTED BY APPLICABLE LAW. EXCEPT WHEN OTHERWISE STATED IN WRITING THE COPYRIGHT HOLDERS AND/OR OTHER PARTIES PROVIDE THE PROGRAM "AS IS" WITHOUT WARRANTY OF ANY KIND, EITHER EXPRESSED OR IMPLIED, INCLUDING, BUT NOT LIMITED TO, THE IMPLIED WARRANTIES OF MERCHANTABILITY AND FITNESS FOR A PARTICULAR PURPOSE. THE ENTIRE RISK AS TO THE QUALITY AND PERFORMANCE OF THE PROGRAM IS WITH YOU. SHOULD THE PROGRAM PROVE DEFECTIVE, YOU ASSUME THE COST OF ALL NECESSARY SERVICING, REPAIR OR CORRECTION.

12. IN NO EVENT UNLESS REQUIRED BY APPLICABLE LAW OR AGREED TO IN WRITING WILL ANY COPYRIGHT HOLDER, OR ANY OTHER PARTY WHO MAY MODIFY AND/OR REDISTRIBUTE THE PROGRAM AS PERMITTED ABOVE, BE LIABLE TO YOU FOR DAMAGES, INCLUDING ANY GENERAL, SPECIAL, INCIDENTAL OR CONSEQUENTIAL DAMAGES ARISING OUT OF THE USE OR INABILITY TO USE THE PROGRAM (INCLUDING BUT NOT LIMITED TO LOSS OF DATA OR DATA BEING RENDERED INACCURATE OR LOSSES SUSTAINED BY YOU OR THIRD PARTIES OR A FAILURE OF THE PROGRAM TO OPERATE WITH ANY OTHER PROGRAMS), EVEN IF SUCH HOLDER OR OTHER PARTY HAS BEEN ADVISED OF THE POSSIBILITY OF SUCH DAMAGES

END OF TERMS AND CONDITIONS

How to Apply These Terms to Your New Programs

If you develop a new program, and you want it to be of the greatest possible use to the public, the best way to achieve this is to make it free software which everyone can redistribute and change under these terms.

To do so, attach the following notices to the program. It is safest to attach them to the start of each source file to most effectively convey the exclusion of warranty; and each file should have at least the "copyright" line and a pointer to where the full notice is found. <one line to give the program's name and a brief idea of what it does.> Copyright (C) <year> <name of author>

This program is free software; you can redistribute it and/or modify it under the terms of the GNU General Public License as published by the Free Software Foundation; either version 2 of the License, or (at your option) any later version.

This program is distributed in the hope that it will be useful, but WITHOUT ANY WARRANTY; without even the implied warranty of MERCHANTABILITY or FITNESS FOR A PARTICULAR PURPOSE. See the GNU General Public License for more details.

You should have received a copy of the GNU General Public License along with this program; if not, write to the Free Software Foundation, Inc., 59 Temple Place, Suite 330, Boston, MA 02111-1307 USA

Also add information on how to contact you by electronic and paper mail.

If the program is interactive, make it output a short notice like this when it starts in an interactive mode:

Gnomovision version 69, Copyright (C) year name of author Gnomovision comes with ABSOLUTELY NO WARRANTY; for details type 'show w'. This is free software, and you are welcome to redistribute it under certain conditions; type 'show c' for details.

The hypothetical commands 'show w' and 'show c' should show the appropriate parts of the General Public License. Of course, the commands you use may be called something other than 'show w' and 'show c'; they could even be mouse-clicks or menu items--whatever suits your program.

You should also get your employer (if you work as a programmer) or your school, if any, to sign a "copyright disclaimer" for the program, if necessary. Here is a sample; alter the names:

Yoyodyne, Inc., hereby disclaims all copyright interest in the program 'Gnomovision' (which makes passes at compilers) written by James Hacker.

<signature of Ty Coon>, 1 April 1989  
Ty Coon, President of Vice

This General Public License does not permit incorporating your program into proprietary programs. If your program is a subroutine library, you may consider it more useful to permit linking proprietary applications with the library. If this is what you want to do, use the GNU Library General Public License instead of this License.

Copyrights:

Copyright (C) 2003 Free Software Foundation, Inc.

Copyright (C) 2005, 2006 Free Software Foundation

Copyright (C) 2007 Free Software Foundation, Inc.

Copyright 1997, 1998, 1999, 2000, 2001, 2002, 2003, 2004, 2005, 2006, 2007, # 2008 Free Software Foundation, Inc.

LICENSE CONDITIONS AND COPYRIGHT NOTICES

Open Source Software: GNU GCC libstdc++ / libsupc++ - 4.3.2  
Enclosed you'll find the license conditions and copyright notices applicable for Open Source Software GNU GCC libstdc++ / libsupc++ - 4.3.2

License conditions:

GCC is free software; you can redistribute it and/or modify it under the terms of the GNU General Public License as published by the Free Software Foundation; either version 2, or (at your option) any later version.

GCC is distributed in the hope that it will be useful, but WITHOUT ANY WARRANTY; without even the implied warranty of MERCHANTABILITY or FITNESS FOR A PARTICULAR PURPOSE. See the GNU General Public License for more details. You should have received a copy of the GNU General Public License along with GCC; see the file COPYING. If not, write to the Free Software Foundation, 51 Franklin Street, Fifth Floor, Boston, MA 02110-1301, USA.

As a special exception, you may use this file as part of a free software library without restriction. Specifically, if other files instantiate templates or use macros or inline functions from this file, or you compile this file and link it with other files to produce an executable, this file does not by itself cause the resulting executable to be covered by the GNU General Public License. This exception does not however invalidate any other reasons why the executable file might be covered by the GNU General Public License.

This library is free software; you can redistribute it and/or modify it under the terms of the GNU General Public License as published by the Free Software Foundation; either version 2, or (at your option) any later version.

This library is distributed in the hope that it will be useful, but WITHOUT ANY WARRANTY; without even the implied warranty of MERCHANTABILITY or FITNESS FOR A PARTICULAR PURPOSE. See the GNU General Public License for more details.

You should have received a copy of the GNU General Public License along with this library; see the file COPYING. If not, write to the Free Software Foundation, 51 Franklin Street, Fifth Floor, Boston, MA 02110-1301, USA.

As a special exception, you may use this file as part of a free software library without restriction. Specifically, if other files instantiate templates or use macros or inline functions from this file, or you compile this file and link it with other files to produce an executable, this file does not by itself cause the resulting executable to be covered by the GNU General Public License. This exception does not however invalidate any other reasons why the executable file might be covered by the GNU General Public License.

This library is free software; you can redistribute it and/or modify it under the terms of the GNU General Public License as published by the Free Software Foundation; either version 2, or (at your option) any later version. This library is distributed in the hope that it will be useful, but WITHOUT ANY WARRANTY; without even the implied warranty of MERCHANTABILITY or FITNESS FOR A PARTICULAR PURPOSE. See the GNU General Public License for more details. You should have received a copy of the GNU General Public License along with this library; see the file COPYING. If not, write to the Free Software Foundation, 59 Temple Place - Suite 330, Boston, MA 02111-1307, USA.

As a special exception, you may use this file as part of a free software library without restriction. Specifically, if other files instantiate templates or use macros or inline functions from this file, or you compile this file and link it with other files to produce an executable, this file does not by itself cause the resulting executable to be covered by the GNU General Public License. This exception does not however invalidate any other reasons why the executable file might be covered by the GNU General Public License. ---

GNU GENERAL PUBLIC LICENSE Version 2, June 1991

Copyright (C) 1989, 1991 Free Software Foundation, Inc.

59 Temple Place, Suite 330, Boston, MA 02111-1307 USA

Everyone is permitted to copy and distribute verbatim copies of this license document, but changing it is not allowed.

#### Preamble

The licenses for most software are designed to take away your freedom to share and change it. By contrast, the GNU General Public License is intended to guarantee your freedom to share and change free software--to make sure the software is free for all its users. This General Public License applies to most of the Free Software Foundation's software and to any other program whose authors commit to using it. (Some other Free Software Foundation software is covered by the GNU Library General Public License instead.) You can apply it to your programs, too.

When we speak of free software, we are referring to freedom, not price. Our General Public Licenses are designed to make sure that you have the freedom to distribute copies of free software (and charge for this service if you wish), that you receive source code or can get it if you want it, that you can change the software or use pieces of it in new free programs; and that you know you can do these things.

To protect your rights, we need to make restrictions that forbid anyone to deny you these rights or to ask you to surrender the rights. These restrictions translate to certain responsibilities for you if you distribute copies of the software, or if you modify it.

For example, if you distribute copies of such a program, whether gratis or for a fee, you must give the recipients all the rights that you have. You must make sure that they, too, receive or can get the source code. And you must show them these terms so they know their rights. We protect your rights with two steps: (1) copyright the software, and (2) offer you this license which gives you legal permission to copy, distribute and/or modify the software.

Also, for each author's protection and ours, we want to make certain that everyone understands that there is no warranty for this free software. If the software is modified by someone else and passed on, we want its recipients to know that what they have is not the original, so that any problems introduced by others will not reflect on the original authors' reputations.

Finally, any free program is threatened constantly by software patents. We wish to avoid the danger that redistributors of a free program will individually obtain patent licenses, in effect making the program proprietary. To prevent this, we have made it clear that any patent must be licensed for everyone's free use or not licensed at all.

The precise terms and conditions for copying, distribution and modification follow.

#### GNU GENERAL PUBLIC LICENSE TERMS AND CONDITIONS FOR COPYING, DISTRIBUTION AND MODIFICATION

0. This License applies to any program or other work which contains a notice placed by the copyright holder saying it may be distributed under the terms of this General Public License. The "Program", below, refers to any such program or work, and a "work based on the Program" means either the Program or any derivative work under copyright law: that is to say, a work containing the Program or a portion of it, either verbatim or with modifications and/or translated into another language. (Hereinafter, translation is included without limitation in the term "modification".) Each licensee is addressed as "you".

Activities other than copying, distribution and modification are not covered by this License; they are outside its scope. The act of running the Program is not restricted, and the output from the Program is covered only if its contents constitute a work based on the Program (independent of having been made by running the Program). Whether that is true depends on what the Program does.

1. You may copy and distribute verbatim copies of the Program's source code as you receive it, in any medium, provided that you conspicuously and appropriately publish on each copy an appropriate copyright notice and disclaimer of warranty; keep intact all the notices that refer to this License and to the absence of any warranty; and give any other recipients of the Program a copy of this License along with the Program. You may charge a fee for the physical act of transferring a copy, and you may at your option offer warranty protection in exchange for a fee.

2. You may modify your copy or copies of the Program or any portion of it, thus forming a work based on the Program, and copy and distribute such modifications or work under the terms of Section 1 above, provided that you also meet all of these conditions:

a) You must cause the modified files to carry prominent notices stating that you changed the files and the date of any change.

b) You must cause any work that you distribute or publish, that in whole or in part contains or is derived from the Program or any part thereof, to be licensed as a whole at no charge to all third parties under the terms of this License.

c) If the modified program normally reads commands interactively when run, you must cause it, when started running for such interactive use in the most ordinary way, to print or display an announcement including an appropriate copyright notice and a notice that there is no warranty (or else, saying that you provide a warranty) and that users may redistribute the program under these conditions, and telling the user how to view a copy of this License. (Exception: if the Program itself is interactive but does not normally print such an announcement, your work based on the Program is not required to print an announcement.)

These requirements apply to the modified work as a whole. If identifiable sections of that work are not derived from the Program, and can be reasonably considered independent and separate works in themselves, then this License, and its terms, do not apply to those sections when you distribute them as separate works. But when you distribute the same sections as part of a whole which is a work based on the Program, the distribution of the whole must be on the terms of this License, whose permissions for other licensees extend to the entire whole, and thus to each and every part regardless of who wrote it.

Thus, it is not the intent of this section to claim rights or contest your rights to work written entirely by you; rather, the intent is to exercise the right to control the distribution of derivative or collective works based on the Program.

In addition, mere aggregation of another work not based on the Program with the Program (or with a work based on the Program) on a volume of a storage or distribution medium does not bring the other work under the scope of this License.

3. You may copy and distribute the Program (or a work based on it, under Section 2) in object code or executable form under the terms of Sections 1 and 2 above provided that you also do one of the following:

a) Accompany it with the complete corresponding machine-readable source code, which must be distributed under the terms of Sections 1 and 2 above on a medium customarily used for software interchange; or,

b) Accompany it with a written offer, valid for at least three years, to give any third party, for a charge no more than your cost of physically performing source distribution, a complete machine-readable copy of the corresponding source code, to be distributed under the terms of Sections 1 and 2 above on a medium customarily used for software interchange; or,

c) Accompany it with the information you received as to the offer to distribute corresponding source code. (This alternative is allowed only for noncommercial distribution and only if you received the program in object code or executable form with such an offer, in accord with Subsection b above.)

The source code for a work means the preferred form of the work for making modifications to it. For an executable work, complete source code means all the source code for all modules it contains, plus any associated interface definition files, plus the scripts used to control compilation and installation of the executable. However, as a special exception, the source code distributed need not include anything that is normally distributed (in either source or binary form) with the major components (compiler, kernel, and so on) of the operating system on which the executable runs, unless that component itself accompanies the executable.

If distribution of executable or object code is made by offering access to copy from a designated place, then offering equivalent access to copy the source code from the same place counts as distribution of the source code, even though third parties are not compelled to copy the source along with the object code.

4. You may not copy, modify, sublicense, or distribute the Program except as expressly provided under this License. Any attempt otherwise to copy, modify, sublicense or distribute the Program is void, and will automatically terminate your rights under this License. However, parties who have received copies, or rights, from you under this License will not have their licenses terminated so long as such parties remain in full compliance.

5. You are not required to accept this License, since you have not signed it. However, nothing else grants you permission to modify or distribute the Program or its derivative works. These actions are prohibited by law if you do not accept this License. Therefore, by modifying or distributing the Program (or any work based on the Program), you indicate your acceptance of this License to do so, and all its terms and conditions for copying, distributing or modifying the Program or works based on it.

6. Each time you redistribute the Program (or any work based on the Program), the recipient automatically receives a license from the original licensor to copy, distribute or modify the Program subject to these terms and conditions. You may not impose any further restrictions on the recipients' exercise of the rights granted herein. You are not responsible for enforcing compliance by third parties to this License.

7. If, as a consequence of a court judgment or allegation of patent infringement or for any other reason (not limited to patent issues), conditions are imposed on you (whether by court order, agreement or otherwise) that contradict the conditions of this License, they do not excuse you from the conditions of this License. If you cannot distribute so as to satisfy simultaneously your obligations under this License and any other pertinent obligations, then as a consequence you may not distribute the Program at all. For example, if a patent license would not permit royalty-free redistribution of the Program by all those who receive copies directly or indirectly through you, then the only way you could satisfy both it and this License would be to refrain entirely from distribution of the Program.

If any portion of this section is held invalid or unenforceable under any particular circumstance, the balance of the section is intended to apply and the section as a whole is intended to apply in other circumstances.

It is not the purpose of this section to induce you to infringe any patents or other property right claims or to contest validity of any such claims; this section has the sole purpose of protecting the integrity of the free software distribution system, which is implemented by public license practices.

Many people have made generous contributions to the wide range of software distributed through that system in reliance on consistent application of that system; it is up to the author/donor to decide if he or she is willing to distribute software through any other system and a licensee cannot impose that choice.

This section is intended to make thoroughly clear what is believed to be a consequence of the rest of this License.

8. If the distribution and/or use of the Program is restricted in certain countries either by patents or by copyrighted interfaces, the original copyright holder who places the Program under this License may add an explicit geographical distribution limitation excluding those countries, so that distribution is permitted only in or among countries not thus excluded. In such case, this License incorporates the limitation as if written in the body of this License.

9. The Free Software Foundation may publish revised and/or new versions of the General Public License from time to time. Such new versions will be similar in spirit to the present version, but may differ in detail to address new problems or concerns.

Each version is given a distinguishing version number. If the Program specifies a version number of this License which applies to it and "any later version", you have the option of following the terms and conditions either of that version or of any later version published by the Free Software Foundation. If the Program does not specify a version number of this License, you may choose any version ever published by the Free Software Foundation.

10. If you wish to incorporate parts of the Program into other free programs whose distribution conditions are different, write to the author to ask for permission. For software which is copyrighted by the Free Software Foundation, write to the Free Software Foundation; we sometimes make exceptions for this. Our decision will be guided by the two goals of preserving the free status of all derivatives of our free software and of promoting the sharing and reuse of software generally.

#### NO WARRANTY

11. BECAUSE THE PROGRAM IS LICENSED FREE OF CHARGE, THERE IS NO WARRANTY FOR THE PROGRAM, TO THE EXTENT PERMITTED BY APPLICABLE LAW. EXCEPT WHEN OTHERWISE STATED IN WRITING THE COPYRIGHT HOLDERS AND/OR OTHER PARTIES PROVIDE THE PROGRAM "AS IS" WITHOUT WARRANTY OF ANY KIND, EITHER EXPRESSED OR IMPLIED, INCLUDING, BUT NOT LIMITED TO, THE IMPLIED WARRANTIES OF MERCHANTABILITY AND FITNESS FOR A PARTICULAR PURPOSE. THE ENTIRE RISK AS TO THE QUALITY AND PERFORMANCE OF THE PROGRAM IS WITH YOU. SHOULD THE PROGRAM PROVE DEFECTIVE, YOU ASSUME THE COST OF ALL NECESSARY SERVICING, REPAIR OR CORRECTION.

12. IN NO EVENT UNLESS REQUIRED BY APPLICABLE LAW OR AGREED TO IN WRITING WILL ANY COPYRIGHT HOLDER, OR ANY OTHER PARTY WHO MAY MODIFY AND/OR REDISTRIBUTE THE PROGRAM AS PERMITTED ABOVE, BE LIABLE TO YOU FOR DAMAGES, INCLUDING ANY GENERAL, SPECIAL, INCIDENTAL OR CONSEQUENTIAL DAMAGES ARISING OUT OF THE USE OR INABILITY TO USE THE PROGRAM (INCLUDING BUT NOT LIMITED TO LOSS OF DATA OR DATA BEING RENDERED INACCURATE OR LOSSES SUSTAINED BY YOU OR THIRD PARTIES OR A FAILURE OF THE PROGRAM TO OPERATE WITH ANY OTHER PROGRAMS), EVEN IF SUCH HOLDER OR OTHER PARTY HAS BEEN ADVISED OF THE POSSIBILITY OF SUCH DAMAGES.

#### END OF TERMS AND CONDITIONS

##### How to Apply These Terms to Your New Programs

If you develop a new program, and you want it to be of the greatest possible use to the public, the best way to achieve this is to make it free software which everyone can redistribute and change under these terms.

To do so, attach the following notices to the program. It is safest to attach them to the start of each source file to most effectively convey the exclusion of warranty; and each file should have at least the "copyright" line and a pointer to where the full notice is found.

<one line to give the program's name and a brief idea of what it does.> Copyright (C) <year> <name of author>

This program is free software; you can redistribute it and/or modify it under the terms of the GNU General Public License as published by the Free Software Foundation; either version 2 of the License, or (at your option) any later version.

This program is distributed in the hope that it will be useful, but WITHOUT ANY WARRANTY; without even the implied warranty of MERCHANTABILITY or FITNESS FOR A PARTICULAR PURPOSE. See the GNU General Public License for more details.

You should have received a copy of the GNU General Public License along with this program; if not, write to the Free Software Foundation, Inc., 59 Temple Place, Suite 330, Boston, MA 02111-1307 USA

Also add information on how to contact you by electronic and paper mail.

If the program is interactive, make it output a short notice like this when it starts in an interactive mode:

Gnomovision version 69, Copyright (C) year name of author  
Gnomovision comes with ABSOLUTELY NO WARRANTY; for details type `show w'. This is free software, and you are welcome to redistribute it under certain conditions; type `show c' for details.

The hypothetical commands `show w' and `show c' should show the appropriate parts of the General Public License. Of course, the commands you use may be called something other than `show w' and `show c'; they could even be mouse-clicks or menu items--whatever suits your program.

You should also get your employer (if you work as a programmer) or your school, if any, to sign a "copyright disclaimer" for the program, if necessary. Here is a sample; alter the names:

Yoyodyne, Inc., hereby disclaims all copyright interest in the program 'Gnomovision' (which makes passes at compilers) written by James Hacker.

<signature of Ty Coon>, 1 April 1989  
Ty Coon, President of Vice

This General Public License does not permit incorporating your program into proprietary programs. If your program is a subroutine library, you may consider it more useful to permit linking proprietary applications with the library. If this is what you want to do, use the GNU Library General Public License instead of this License.

Distributed under the Boost  
Software License, Version 1.0.  
(See accompanying file LICENSE\_1\_0.txt or copy at  
[http://www.boost.org/LICENSE\\_1\\_0.txt](http://www.boost.org/LICENSE_1_0.txt))

---  
Boost Software License - Version 1.0 - August 17th, 2003

Permission is hereby granted, free of charge, to any person or organization obtaining a copy of the software and accompanying documentation covered by this license (the "Software") to use, reproduce, display, distribute, execute, and transmit the Software, and to prepare derivative works of the Software, and to permit third-parties to whom the Software is furnished to do so, all subject to the following:

The copyright notices in the Software and this entire statement, including the above license grant, this restriction and the following disclaimer, must be included in all copies of the Software, in whole or in part, and all derivative works of the Software, unless such copies or derivative works are solely in the form of machine-executable object code generated by a source language processor.

THE SOFTWARE IS PROVIDED "AS IS", WITHOUT WARRANTY OF ANY KIND, EXPRESS OR IMPLIED, INCLUDING BUT NOT LIMITED TO THE WARRANTIES OF MERCHANTABILITY, FITNESS FOR A PARTICULAR PURPOSE, TITLE AND NON-INFRINGEMENT. IN NO EVENT SHALL THE COPYRIGHT HOLDERS OR ANYONE DISTRIBUTING THE SOFTWARE BE LIABLE FOR ANY DAMAGES OR OTHER LIABILITY, WHETHER IN CONTRACT, TORT OR OTHERWISE, ARISING FROM, OUT OF OR IN CONNECTION WITH THE SOFTWARE OR THE USE OR OTHER DEALINGS IN THE SOFTWARE.

Permission to use, copy, modify, distribute and sell this software and its documentation for any purpose is hereby granted without fee, provided that the above copyright notice appear in all copies and that both that copyright notice and this permission notice appear in supporting documentation. Silicon Graphics makes no representations about the suitability of this software for any purpose. It is provided "as is" without express or implied warranty.

Permission to use, copy, modify, sell, and distribute this software is hereby granted without fee, provided that the above copyright notice appears in all copies, and that both that copyright notice and this permission notice appear in supporting documentation. None of the above authors, nor IBM Haifa Research Laboratories, make any representation about the suitability of this software for any purpose. It is provided "as is" without express or implied warranty.

Permission to use, copy, modify, distribute and sell this software and its documentation for any purpose is hereby granted without fee, provided that the above copyright notice appear in all copies and that both that copyright notice and this permission notice appear in supporting documentation. Hewlett-Packard Company makes no representations about the suitability of this software for any purpose. It is provided "as is" without express or implied warranty.

#### Copyrights:

(C) Copyright Jeremy Siek 2000.

Copyright &copy; 1994 Hewlett-Packard Company

Copyright &copy; 1998 by Information Technology Industry Council.

Copyright &copy; 2007 Free Software Foundation, Inc.

Copyright (C) Microsoft Corporation 1984-2002. All rights reserved.

Copyright (C) 1994, 1995, 1996, 1997, 1998, 1999, 2000, 2001 // Free Software Foundation

Copyright (C) 1994, 1995, 1996, 1997, 1998, 1999, 2000, 2001, 2002 // Free Software Foundation

Copyright (C) 1994, 1995, 1996, 1997, 1998, 1999, 2000, 2001, 2002, # 2003, 2004, 2005 Free Software Foundation, Inc.

Copyright (C) 1994, 1995, 1996, 1997, 1998, 1999, 2000, 2001, 2002, // 2003, 2004, 2005, 2006, 2007 // Free Software Foundation

Copyright (C) 1994, 1995, 1996, 1997, 1998, 1999, 2000, 2001, 2002, // 2003, 2004, 2005, 2006, 2007 Free Software Foundation, Inc.

Copyright (C) 1994, 1995, 1996, 1998, 1999, 2000, 2001, 2004 // Free Software Foundation

Copyright (C) 1994, 1996, 1997, 1998, 1999, 2000, 2001, 2002 // Free Software Foundation

Copyright (C) 1994, 1996, 1997, 1998, 1999, 2000, 2001, 2002, 2007 // Free Software Foundation

Copyright (C) 1994, 1999, 2000, 2003 Free Software Foundation, Inc.

Copyright (C) 1994, 1999, 2000, 2003, 2005 Free Software Foundation, Inc.

Copyright (C) 1994, 1999, 2001, 2002, 2003 Free Software Foundation, Inc.

Copyright (C) 1994, 1999, 2001, 2003 Free Software Foundation, Inc.

Copyright (C) 1995, 1996, 1997, 1998, 1999, 2000, 2001, 2002, 2003, // 2004, 2005, 2006, 2007 // Free Software Foundation

Copyright (C) 1996, 1997, 1998, 1999, 2000, 2001, 2002, 2003, 2004, # 2005 Free Software Foundation, Inc.

Copyright (C) 1996, 1997, 1998, 1999, 2000, 2001, 2002, 2003, 2004, // 2005, 2006, 2007 // Free Software Foundation

Copyright (C) 1996, 1997, 1998, 1999, 2000, 2001, 2002, 2003, 2004, 2005 # Free Software Foundation, Inc.





Copyright (C) 1998, 1999, 2003, 2004 Free Software Foundation, Inc.

Copyright (C) 1999 Free Software Foundation, Inc.

Copyright (C) 1999, 2000 Free Software Foundation, Inc.

Copyright (C) 1999, 2000, 2001, 2002, 2003 Free Software Foundation

Copyright (C) 1999, 2000, 2001, 2002, 2003 Free Software Foundation, Inc.

Copyright (C) 1999, 2000, 2001, 2002, 2003, 2004 // Free Software Foundation, Inc.

Copyright (C) 1999, 2000, 2001, 2002, 2003, 2004 Free Software Foundation

Copyright (C) 1999, 2000, 2001, 2002, 2003, 2004, 2005 // Free Software Foundation, Inc.

Copyright (C) 1999, 2000, 2001, 2002, 2003, 2004, 2005, 2006 // Free Software Foundation

Copyright (C) 1999, 2000, 2001, 2002, 2003, 2004, 2005, 2006 // Free Software Foundation, Inc.

Copyright (C) 1999, 2000, 2001, 2002, 2003, 2004, 2005, 2006, 2007 // Free Software Foundation, Inc.

Copyright (C) 1999, 2000, 2001, 2002, 2003, 2004, 2005, 2006, 2007, 2008 // Free Software Foundation, Inc.

Copyright (C) 1999, 2000, 2001, 2002, 2003, 2005 // Free Software Foundation, Inc.

Copyright (C) 1999, 2000, 2001, 2002, 2003, 2005 Free Software Foundation

Copyright (C) 1999, 2000, 2001, 2002, 2003, 2006 // Free Software Foundation, Inc.

Copyright (C) 1999, 2000, 2001, 2002, 2004, 2005 // Free Software Foundation, Inc.

Copyright (C) 1999, 2000, 2001, 2003 Free Software Foundation

Copyright (C) 1999, 2000, 2001, 2003, 2004, 2005 // Free Software Foundation, Inc.

Copyright (C) 1999, 2000, 2001, 2004, 2005 Free Software Foundation, Inc.

Copyright (C) 1999, 2000, 2002, 2003 Free Software Foundation

Copyright (C) 1999, 2000, 2002, 2003 Free Software Foundation, Inc.

Copyright (C) 1999, 2000, 2002, 2003, 2004, 2005 // Free Software Foundation, Inc.

Copyright (C) 1999, 2000, 2002, 2003, 2005 Free Software Foundation

Copyright (C) 1999, 2000, 2003 Free Software Foundation

Copyright (C) 1999, 2000, 2003 Free Software Foundation, Inc.

Copyright (C) 1999, 2001, 2002, 2003, 2004 Free Software Foundation

Copyright (C) 1999, 2001, 2002, 2003, 2004, 2005 // Free Software Foundation, Inc.

Copyright (C) 1999, 2001, 2002, 2003, 2004, 2005 Free Software Foundation

Copyright (C) 1999, 2001, 2002, 2003, 2004, 2005, 2006 // Free Software Foundation, Inc.

Copyright (C) 1999, 2001, 2002, 2005, 2006 Free Software Foundation, Inc.

Copyright (C) 1999, 2001, 2003 Free Software Foundation

Copyright (C) 1999, 2001, 2003 Free Software Foundation, Inc.

Copyright (C) 1999, 2001, 2003, 2004 Free Software Foundation

Copyright (C) 1999, 2001, 2003, 2007 Free Software Foundation, Inc.

Copyright (C) 1999, 2001, 2004, 2005 Free Software Foundation, Inc.

Copyright (C) 1999, 2002 Free Software Foundation, Inc.

Copyright (C) 1999, 2002, 2003 Free Software Foundation, Inc.

Copyright (C) 1999, 2002, 2003, 2004 Free Software Foundation, Inc.

Copyright (C) 1999, 2002, 2003, 2004, 2005 // Free Software Foundation, Inc.

Copyright (C) 1999, 2002, 2003, 2004, 2005 Free Software Foundation, Inc.

Copyright (C) 1999, 2002, 2003, 2005 Free Software Foundation, Inc.

Copyright (C) 1999, 2002, 2004, 2005 Free Software Foundation, Inc.

Copyright (C) 1999, 2003 Free Software Foundation

Copyright (C) 1999, 2003 Free Software Foundation, Inc.

Copyright (C) 1999, 2003, 2004, 2005 Free Software Foundation, Inc.

Copyright (C) 1999, 2003, 2005 Free Software Foundation

Copyright (C) 1999, 2003, 2005 Free Software Foundation, Inc.

Copyright (C) 1999, 2004, 2005 Free Software Foundation, Inc.

Copyright (C) 1999, 2007 Free Software Foundation, Inc.

Copyright (C) 1999-2001, 2002, 2003 Free Software Foundation, Inc.

Copyright (C) 1999-2001, 2002, 2003, 2004, 2005 // Free Software Foundation, Inc.

Copyright (C) 2000 Free Software Foundation, Inc.

Copyright (C) 2000, 1999 Free Software Foundation, Inc.

Copyright (C) 2000, 2001 Free Software Foundation

Copyright (C) 2000, 2001, 2002 Free Software Foundation,

Copyright (C) 2000, 2001, 2002 Free Software Foundation, <abbrev>Inc.</abbrev> 51 Franklin <abbrev>St</abbrev>, Fifth Floor, Boston, <abbrev>MA</abbrev> 02110-1301

Copyright (C) 2000, 2001, 2002 Free Software Foundation, Inc.

Copyright (C) 2000, 2001, 2002, 2003 Free Software Foundation

Copyright (C) 2000, 2001, 2002, 2003 Free Software Foundation, Inc.

Copyright (C) 2000, 2001, 2002, 2003, 2004 Free Software Foundation

Copyright (C) 2000, 2001, 2002, 2003, 2004, 2005 // Free Software Foundation, Inc.

Copyright (C) 2000, 2001, 2002, 2003, 2004, 2005, 2006 // Free Software Foundation

Copyright (C) 2000, 2001, 2002, 2003, 2004, 2005, 2006 // Free Software Foundation, Inc.

Copyright (C) 2000, 2001, 2002, 2003, 2004, 2005, 2006, 2007 // Free Software Foundation, Inc.

Copyright (C) 2000, 2001, 2002, 2003, 2004, 2005, 2006, 2007 // Free Software Foundation

Copyright (C) 2000, 2001, 2002, 2003, 2004, 2005, 2006, 2007 // Free Software Foundation, Inc.

Copyright (C) 2000, 2001, 2002, 2003, 2004, 2005, 2006, 2007, 2008 // Free

Software Foundation, Inc.  
Copyright (C) 2000, 2001, 2002, 2003, 2004, 2005, 2007 ## Free Software Foundation, Inc.  
Copyright (C) 2000, 2001, 2002, 2003, 2004, 2006, 2007 // Free Software Foundation, Inc.  
Copyright (C) 2000, 2001, 2002, 2003, 2005 Free Software Foundation  
Copyright (C) 2000, 2001, 2002, 2003, 2005 Free Software Foundation, Inc.  
Copyright (C) 2000, 2001, 2002, 2003, 2006 Free Software Foundation, Inc.  
Copyright (C) 2000, 2001, 2002, 2003, 2007 Free Software Foundation  
Copyright (C) 2000, 2001, 2003 Free Software Foundation, Inc.  
Copyright (C) 2000, 2001, 2003, 2004 Free Software Foundation, Inc.  
Copyright (C) 2000, 2001, 2003, 2004, 2005 Free Software Foundation, Inc.  
Copyright (C) 2000, 2001, 2003, 2004, 2005, 2006 // Free Software Foundation, Inc.  
Copyright (C) 2000, 2001, 2003, 2005 Free Software Foundation, Inc.  
Copyright (C) 2000, 2001, 2004, 2005 Free Software Foundation, Inc.  
Copyright (C) 2000, 2001, 2005, 2006 Free Software Foundation, Inc.  
Copyright (C) 2000, 2002 Free Software Foundation, Inc.  
Copyright (C) 2000, 2002, 2003 Free Software Foundation  
Copyright (C) 2000, 2002, 2003 Free Software Foundation, Inc.  
Copyright (C) 2000, 2002, 2003, 2004 Free Software Foundation  
Copyright (C) 2000, 2002, 2003, 2004, 2006, 2007 Free Software Foundation, Inc.  
Copyright (C) 2000, 2002, 2003, 2005 Free Software Foundation  
Copyright (C) 2000, 2002, 2004, 2005 Free Software Foundation, Inc.  
Copyright (C) 2000, 2002, 2005 Free Software Foundation, Inc.  
Copyright (C) 2000, 2002, 2005, 2008 Free Software Foundation, Inc.  
Copyright (C) 2000, 2002, 2006 Free Software Foundation, Inc.  
Copyright (C) 2000, 2003 Free Software Foundation  
Copyright (C) 2000, 2003 Free Software Foundation, Inc.  
Copyright (C) 2000, 2003, 2004 Free Software Foundation  
Copyright (C) 2000, 2003, 2004 Free Software Foundation, Inc.  
Copyright (C) 2000, 2003, 2004, 2005 Free Software Foundation, Inc.  
Copyright (C) 2000, 2005 Free Software Foundation, Inc.  
Copyright (C) 2001 Free Software Foundation  
Copyright (C) 2001 Free Software Foundation, Inc.  
Copyright (C) 2001 Free Software Foundation, Inc. # Benjamin Kosnik <bkoz@redhat.com>, 2001.  
Copyright (C) 2001, 2002 Free Software Foundation, Inc.  
Copyright (C) 2001, 2002, 2003 Free Software Foundation  
Copyright (C) 2001, 2002, 2003 Free Software Foundation, Inc.  
Copyright (C) 2001, 2002, 2003 Peter Dimov  
Copyright (C) 2001, 2002, 2003, 2004 Free Software Foundation  
Copyright (C) 2001, 2002, 2003, 2004 Free Software Foundation, Inc.  
Copyright (C) 2001, 2002, 2003, 2004, 2005 Free Software Foundation  
Copyright (C) 2001, 2002, 2003, 2004, 2005 Free Software Foundation, Inc.  
Copyright (C) 2001, 2002, 2003, 2004, 2005, 2006 // Free Software Foundation, Inc.  
Copyright (C) 2001, 2002, 2003, 2004, 2005, 2006, 2007 // Free Software Foundation  
Copyright (C) 2001, 2002, 2003, 2004, 2005, 2006, 2007 // Free Software Foundation, Inc.  
Copyright (C) 2001, 2002, 2003, 2004, 2005, 2006, 2007 // Free Software Foundation  
Copyright (C) 2001, 2002, 2003, 2004, 2005, 2006, 2007 // Free Software Foundation, Inc.  
Copyright (C) 2001, 2002, 2003, 2004, 2005, 2006, 2007, 2008 ## Free Software Foundation, Inc.  
Copyright (C) 2001, 2002, 2003, 2004, 2005, 2006, 2007, 2008 // Free Software Foundation  
Copyright (C) 2001, 2002, 2003, 2004, 2005, 2006, 2007, 2008 // Free Software Foundation, Inc.  
Copyright (C) 2001, 2002, 2003, 2004, 2008 Free Software Foundation, Inc.  
Copyright (C) 2001, 2002, 2003, 2005 Free Software Foundation, Inc.  
Copyright (C) 2001, 2002, 2003, 2005 Free Software Foundation  
Copyright (C) 2001, 2002, 2003, 2005 Free Software Foundation, Inc.  
Copyright (C) 2001, 2002, 2003, 2005, 2006 Free Software Foundation  
Copyright (C) 2001, 2002, 2003, 2005, 2007 Free Software Foundation, Inc.  
Copyright (C) 2001, 2002, 2003, 2006 Free Software Foundation, Inc.  
Copyright (C) 2001, 2002, 2003, 2006, 2008 Free Software Foundation, Inc.  
Copyright (C) 2001, 2002, 2004 Free Software Foundation, Inc.  
Copyright (C) 2001, 2002, 2004, 2005 Free Software Foundation  
Copyright (C) 2001, 2002, 2004, 2005 Free Software Foundation, Inc.  
Copyright (C) 2001, 2002, 2004, 2005, 2006 Free Software Foundation, Inc.  
Copyright (C) 2001, 2002, 2004, 2005, 2007 Free Software Foundation, Inc.  
Copyright (C) 2001, 2002, 2004, 2005, 2008 Free Software Foundation, Inc.  
Copyright (C) 2001, 2002, 2004, 2006 Free Software Foundation, Inc.  
Copyright (C) 2001, 2002, 2005 Free Software Foundation, Inc.  
Copyright (C) 2001, 2002, 2005, 2007 Free Software Foundation, Inc.  
Copyright (C) 2001, 2002, 2005, 2008 Free Software Foundation, Inc. See license.html for license.  
Copyright (C) 2001, 2003 Free Software Foundation  
Copyright (C) 2001, 2003 Free Software Foundation

Copyright (C) 2001, 2003 Free Software Foundation, Inc.  
 Copyright (C) 2001, 2003, 2004 Free Software Foundation, Inc.  
 Copyright (C) 2001, 2003, 2004, 2005 Free Software Foundation, Inc.  
 Copyright (C) 2001, 2003, 2005 Free Software Foundation, Inc.  
 Copyright (C) 2001, 2003, 2005 Free Software Foundation  
 Copyright (C) 2001, 2003, 2007 Free Software Foundation, Inc.  
 Copyright (C) 2001, 2004 Free Software Foundation, Inc.  
 Copyright (C) 2001, 2004, 2005 Free Software Foundation, Inc.  
 Copyright (C) 2001, 2005 Free Software Foundation, Inc.  
 Copyright (C) 2001, 2007 Free Software Foundation, Inc.  
 Copyright (C) 2002 // Free Software Foundation, Inc.  
 Copyright (C) 2002 Free Software Foundation  
 Copyright (C) 2002 Free Software Foundation, Inc.  
 Copyright (C) 2002 Peter Dimov  
 Copyright (C) 2002, 2003 Free Software Foundation  
 Copyright (C) 2002, 2003 Free Software Foundation, Inc.  
 Copyright (C) 2002, 2003, 2004, 2005 Free Software Foundation  
 Copyright (C) 2002, 2003, 2004, 2005 Free Software Foundation, Inc.  
 Copyright (C) 2002, 2003, 2004, 2005, 2006, 2007 // Free Software Foundation, Inc.  
 Copyright (C) 2002, 2003, 2004, 2005, 2006, 2007, 2008 ## Free Software Foundation, Inc.  
 Copyright (C) 2002, 2003, 2004, 2005, 2006, 2007, 2008 Free // Software Foundation  
 Copyright (C) 2002, 2003, 2004, 2005, 2007 Free Software Foundation, Inc.  
 Copyright (C) 2002, 2003, 2004, 2007 Free Software Foundation, Inc.  
 Copyright (C) 2002, 2003, 2005 Free Software Foundation, Inc.  
 Copyright (C) 2002, 2003, 2005 Free Software Foundation, Inc.  
 Copyright (C) 2002, 2003, 2007 Free Software Foundation, Inc.  
 Copyright (C) 2002, 2004 Free Software Foundation  
 Copyright (C) 2002, 2004 Free Software Foundation, Inc.  
 Copyright (C) 2002, 2004, 2005 Free Software Foundation, Inc.  
 Copyright (C) 2002, 2004, 2005, 2007 Free Software Foundation, Inc.  
 Copyright (C) 2002, 2004, 2006 Free Software Foundation, Inc.  
 Copyright (C) 2002, 2005, 2007 Free Software Foundation, Inc.  
 Copyright (C) 2002, 2007 Free Software Foundation, Inc.  
 Copyright (C) 2003 // Free Software Foundation, Inc.  
 Copyright (C) 2003 Free Software Foundation  
 Copyright (C) 2003 Free Software Foundation, Inc.  
 Copyright (C) 2003, 2004 // Free Software Foundation, Inc.  
 Copyright (C) 2003, 2004 Free Software Foundation  
 Copyright (C) 2003, 2004 Free Software Foundation, Inc.  
 Copyright (C) 2003, 2004, 2005 // Free Software Foundation, Inc.  
 Copyright (C) 2003, 2004, 2005 Free Software Foundation, Inc.  
 Copyright (C) 2003, 2004, 2005 Free Software Foundation  
 Copyright (C) 2003, 2004, 2005 Free Software Foundation, Inc.  
 Copyright (C) 2003, 2004, 2005, 2006 // Free Software Foundation, Inc.  
 Copyright (C) 2003, 2004, 2005, 2006 Free Software Foundation  
 Copyright (C) 2003, 2004, 2005, 2006 Free Software Foundation, Inc.  
 Copyright (C) 2003, 2004, 2005, 2006, 2007 // Free Software Foundation, Inc.  
 Copyright (C) 2003, 2004, 2005, 2006, 2007 Free Software Foundation  
 Copyright (C) 2003, 2004, 2005, 2006, 2007 Free Software Foundation, Inc.  
 Copyright (C) 2003, 2004, 2005, 2006, 2007, 2008 // Free Software Foundation, Inc.  
 Copyright (C) 2003, 2004, 2005, 2006, 2007, 2008 Free Software // Foundation, Inc.  
 Copyright (C) 2003, 2004, 2005, 2007 Free Software Foundation  
 Copyright (C) 2003, 2004, 2005, 2007 Free Software Foundation, Inc.  
 Copyright (C) 2003, 2004, 2006 Free Software Foundation, Inc.  
 Copyright (C) 2003, 2005 Free Software Foundation  
 Copyright (C) 2003, 2005 Free Software Foundation, Inc.  
 Copyright (C) 2003, 2005, 2006 // Free Software Foundation, Inc.  
 Copyright (C) 2003, 2005, 2006 Free Software Foundation, Inc.  
 Copyright (C) 2003, 2006 // Free Software Foundation, Inc.  
 Copyright (C) 2003, 2007 Free Software Foundation, Inc.  
 Copyright (C) 2004 Ami Tavory and Vladimir Dreizin, IBM-HRL.  
 Copyright (C) 2004 Free Software Foundation  
 Copyright (C) 2004 Free Software Foundation, Inc.  
 Copyright (C) 2004, 2005 Free Software Foundation, Inc.  
 Copyright (C) 2004, 2005 Free Software Foundation  
 Copyright (C) 2004, 2005 Free Software Foundation, Inc.  
 Copyright (C) 2004, 2005, 2006 Free Software Foundation  
 Copyright (C) 2004, 2005, 2006 Free Software Foundation, Inc.  
 Copyright (C) 2004, 2005, 2006, 2007 Free Software Foundation  
 Copyright (C) 2004, 2005, 2006, 2007 Free Software Foundation, Inc.  
 Copyright (C) 2004, 2005, 2006, 2007, 2008 // Free Software Foundation, Inc.  
 Copyright (C) 2004, 2005, 2006, 2007, 2008 Free Software Foundation, Inc.  
 Copyright (C) 2004, 2005, 2007 Free Software Foundation  
 Copyright (C) 2004, 2005, 2007 Free Software Foundation, Inc.  
 Copyright (C) 2004, 2006 Free Software Foundation, Inc.  
 Copyright (C) 2004, 2006, 2008 Free Software Foundation, Inc.

Copyright (C) 2004, 2007 Free Software Foundation, Inc.  
Copyright (C) 2005 Free Software Foundation, Inc.  
Copyright (C) 2005 Free Software Foundation  
Copyright (C) 2005 Free Software Foundation, Inc.  
Copyright (C) 2005, 2006 // Free Software Foundation, Inc.  
Copyright (C) 2005, 2006 Free Software Foundation, Inc.  
Copyright (C) 2005, 2006, 2007 Free Software Foundation  
Copyright (C) 2005, 2006, 2007 Free Software Foundation, Inc.  
Copyright (C) 2005, 2006, 2007, 2008 Free Software Foundation, Inc.  
Copyright (C) 2005, 2006, 2008 Free Software Foundation, Inc.  
Copyright (C) 2005, 2007 Free Software Foundation, Inc.  
Copyright (C) 2006 // Free Software Foundation, Inc.  
Copyright (C) 2006 Free Software Foundation  
Copyright (C) 2006 Free Software Foundation  
Copyright (C) 2006 Free Software Foundation, Inc.  
Copyright (C) 2006, 2006 Free Software Foundation  
Copyright (C) 2006, 2007 Free Software Foundation  
Copyright (C) 2006, 2007 Free Software Foundation, Inc.  
Copyright (C) 2006, 2007, 2008 // Free Software Foundation, Inc.  
Copyright (C) 2006, 2007, 2008 Free Software Foundation  
Copyright (C) 2006, 2007, 2008 Free Software Foundation, Inc.  
Copyright (C) 2006, 2008 // Free Software Foundation, Inc.  
Copyright (C) 2006-2007 Free Software Foundation, Inc.  
Copyright (C) 2007 // Free Software Foundation, Inc.  
Copyright (C) 2007 Free Software Foundation  
Copyright (C) 2007 Free Software Foundation, Inc.  
Copyright (C) 2007, 2008 Free Software Foundation  
Copyright (C) 2007, 2008 Free Software Foundation, Inc.  
Copyright (C) 2007, 2008 Free Software Foundation, Inc.  
Copyright (C) 2007, 2008 Free Software Foundation, Inc.  
Copyright (C) 2008 Free Software Foundation  
Copyright (C) 2008 Free Software Foundation, Inc.  
Copyright (c) 1994 \* Hewlett-Packard Company  
Copyright (c) 1996 \* Silicon Graphics Computer Systems, Inc.  
Copyright (c) 1996, 1997 \* Silicon Graphics  
Copyright (c) 1996, 1997 \* Silicon Graphics Computer Systems, Inc.  
Copyright (c) 1996-1997 \* Silicon Graphics Computer Systems, Inc.  
Copyright (c) 1996-1998 \* Silicon Graphics Computer Systems, Inc.  
Copyright (c) 1996-1999 \* Silicon Graphics Computer Systems, Inc.  
Copyright (c) 1997 \* Silicon Graphics Computer Systems, Inc.

Copyright (c) 1997-1999 \* Silicon Graphics Computer Systems, Inc.  
Copyright (c) 1998 \* Silicon Graphics Computer Systems, Inc.  
Copyright (c) 2001, 2002, 2003 Peter Dimov and Multi Media Ltd.  
Copyright 2008 FSF</p>  
<div><p>Copyright Ami Tavory and Vladimir Dreizin, IBM-HRL, 2004, and Benjamin Kosnik, Red Hat, 2004.  
</p></div><div><p>Copyright Å© 1989, 1991 Free Software Foundation, Inc.</p></div><div><p>Copyright Å© 1998 ISO.  
</p></div><div><p>Copyright Å© 1999 The Open Group/The Institute of Electrical and Electronics Engineers, Inc..</p></div><div><p>Copyright Å© 1999 ISO.  
</p></div><div><p>Copyright Å© 2000 Addison Wesley Longman, Inc..</p></div><div><p>Copyright Å© 2000 Addison Wesley, Inc..</p></div><div><p>Copyright Å© 2000, 2001, 2002, 2003, 2004, 2005, 2006, 2007, 2008</p></div><div><p>Copyright Å© 2002 OOPSLA.  
</p></div><div><p>Copyright Å© 2004, 2005, 2006, 2007 Free Software Foundation, Inc., 51 Franklin Street, Fifth Floor, Boston, MA 02110-1301, USA</p></div><div><p>Copyright Å© 2004, 2005, 2006, 2007 Free Software Foundation, Inc., 51 Franklin Street, Fifth Floor, Boston, MA 02110-1301, USA</p></div><div><p>Copyright Å© 2007 FSF.  
</p></div><div><p>Copyrighted by the Free Software Foundation  
</p></div><div><p>Copyrighted by the Free Software Foundation  
</p></div>