

Steckrelaiskoppler

Plug-in relay coupler
Relais interface embrochable
Interfaz de relé enchufable
Accoppiatore a relè innestabile
Acoplador de relé de encaixe
Sokma röle kuplörü
Соединительное реле, штеккерное

LZS:PT
LZS:RT

CE IEC 61810-1

Betriebsanleitung Istruzioni operative	Operating Instructions Instruções de Serviço	Instructions de service İşletme kılavuzu	Instructivo Руководство по эксплуатации
---	---	---	--

	Deutsch	English	Français	Español
	Vor der Installation, dem Betrieb oder der Wartung des Geräts muss diese Anleitung gelesen und verstanden werden.	Read and understand these instructions before installing, operating, or maintaining the equipment.	Ne pas installer, utiliser ou intervenir sur cet équipement avant d'avoir lu et assimilé les présentes instructions et notamment les conseils de sécurité et mises en garde qui y figurent.	Leer y comprender este instructivo antes de la instalación, operación o mantenimiento del equipo.
	⚠ GEFÄHR	⚠ DANGER	⚠ DANGER	⚠ PELIGRO
	Gefährliche Spannung. Lebensgefahr oder schwere Verletzungsgefahr. Vor Beginn der Arbeiten Anlage und Gerät spannungsfrei schalten.	Hazardous voltage. Will cause death or serious injury. Turn off and lock out all power supplying this device before working on this device.	Tension électrique. Danger de mort ou risque de blessures graves. Mettez hors tension avant d'intervenir sur l'appareil.	Tensión peligrosa. Puede causar la muerte o lesiones graves. Desconectar la alimentación eléctrica antes de trabajar en el equipo.
	VORSICHT	CAUTION	PRUDENCE	PRECAUCIÓN
	Eine sichere Gerätefunktion ist nur mit zertifizierten Komponenten gewährleistet.	Reliable functioning of the equipment is only ensured with certified components.	La sécurité de fonctionnement de l'appareil n'est garantie qu'avec des composants certifiés.	El funcionamiento seguro del aparato sólo está garantizado con componentes certificados.

	Italiano	Português	Türkçe	Русский
	Leggere con attenzione queste istruzioni prima di installare, utilizzare o eseguire manutenzione su questa apparecchiatura.	Ler e compreender estas instruções antes da instalação, operação ou manutenção do equipamento.	Cihazın kurulumundan, çalıştırılmasından veya bakıma tabi tutulmasından önce, bu kılavuzun okunmuş ve anlaşılması gerekmektedir.	Перед установкой, вводом в эксплуатацию или обслуживанием устройства необходимо прочесть и понять данное руководство.
	⚠ PERICOLO	⚠ PERIGO	⚠ TEHLİKE	⚠ ОПАСНО
	Tensione pericolosa. Può provocare morte o lesioni gravi. Scollegare l'alimentazione prima di eseguire interventi sull'apparecchiatura.	Tensão perigosa. Perigo de morte ou ferimentos graves. Desligue a corrente antes de trabalhar no equipamento.	Tehlikeli gerilim. Ölüm tehlikesi veya ağır yaralanma tehlikesi mevcuttur. Çalışmalara başlamadan önce, sistemin ve cihazın enerjisini kesiniz.	Опасное напряжение. Опасность для жизни или возможность тяжелых травм. Перед началом работ отключить подачу питания к установке и к устройству.
	CAUTELA	CUIDADO	ÖNEMLİ DİKKAT	ОСТОРОЖНО
	Il funzionamento sicuro dell'apparecchiatura è garantito soltanto con componenti certificati.	O funcionamento seguro do aparelho apenas pode ser garantido se forem utilizados os componentes certificados.	Cihazın güvenli çalışması ancak sertifikalı bileşenler kullanılması halinde garanti edilebilir.	Безопасность работы устройства гарантировано только при использовании сертифицированных компонентов.

Technical Assistance: Telephone: +49 (911) 895-5900 (8° - 17° CET) Fax: +49 (911) 895-5907 E-mail: technical-assistance@siemens.com Internet: www.siemens.com/industrial-controls/technical-assistance	SIEMENS AG Technical Assistance Würzburger Str. 121 D-90766 Fürth
--	--

LZS: PT.A/BD. ...
LZS:RT.A/BD. ...

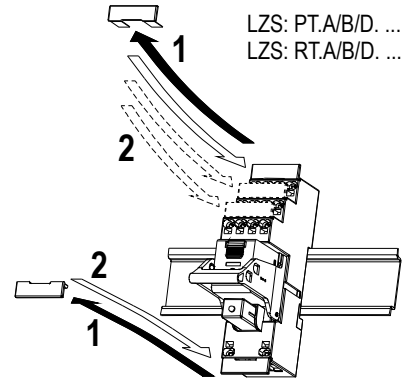
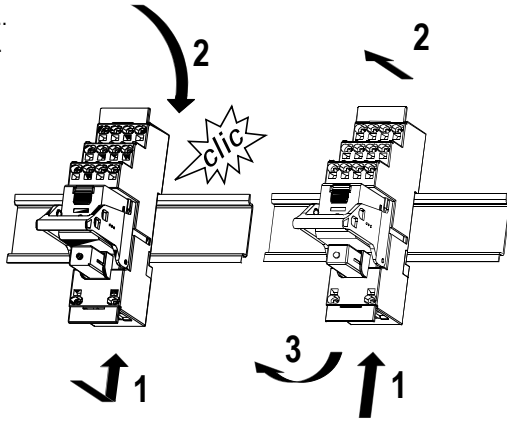

LZS: PT.A/BD. ...
LZS:RT.A/BD. ...

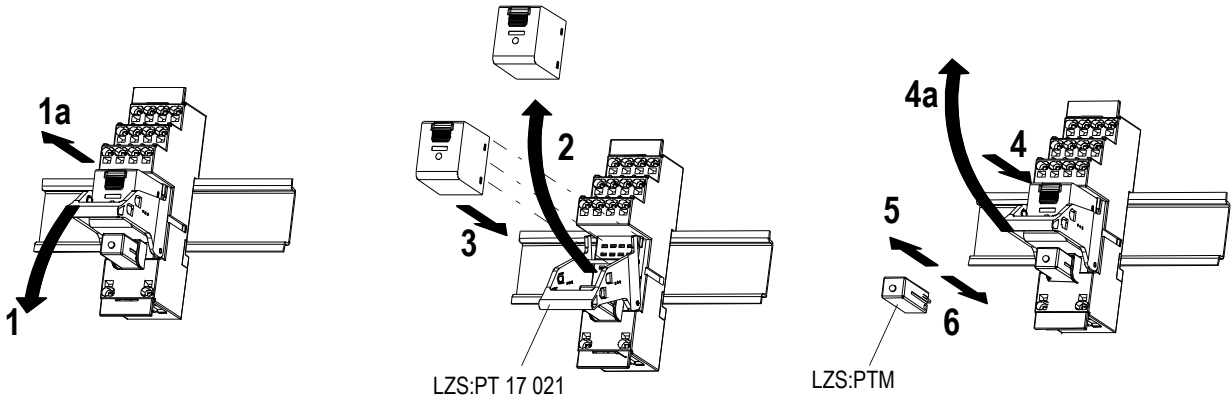

LZS: PT17024

LZS: PT78720
LZS: PT78730
LZS: PT78740

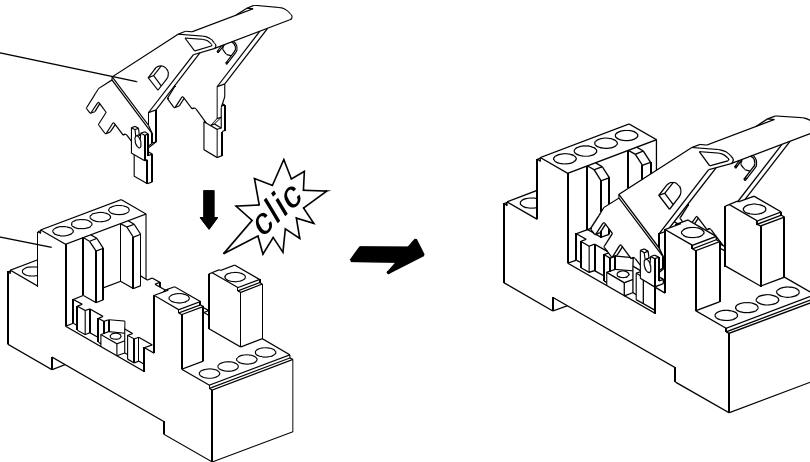

LZS: PT78720
LZS: PT78730
LZS: PT78740

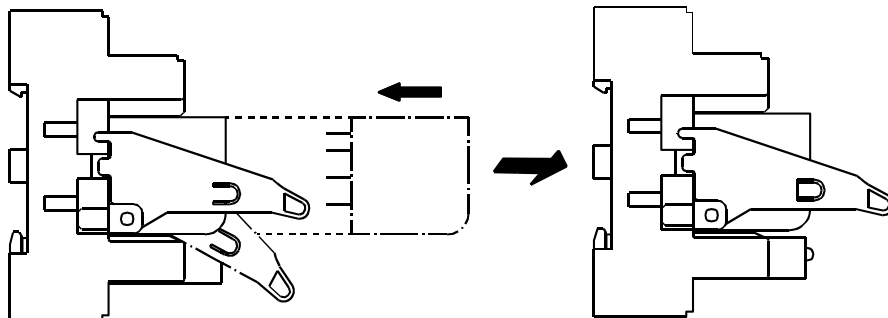

Montage Richtung
Mounting direction
Direction de montage
Sentido de montaje
Direzione di montaggio
Sentido de montagem
Montaj yönü
Направление монтажа

Verriegelung
Interlocking
Verrouillage
Enclavamiento
Interblocco
Travamento
Kilitleme
Блокировка

Demontage Richtung
Removal direction
Direction de démontage
Sentido de desmontaje
Direzione di smontaggio
Sentido de desmontagem
Sökme yönü
Направление демонтажа

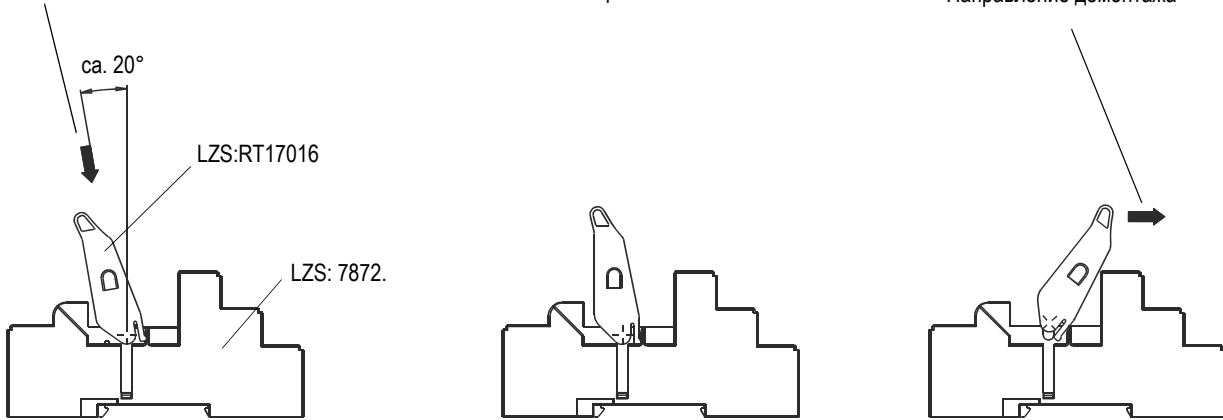

DE	Die Auswerfbügel LZS:PT17021, LZS:PT17024 und LZS:RT17016 sind keine Statusanzeigen oder Montagehilfen!
EN	The ejection brackets LZS:PT17021, LZS:PT17024 and LZS:RT17016 are neither status indicators nor mounting aids!
FR	Les éjecteurs LZS:PT17021, LZS:PT17024 et LZS:RT17016 ne sont ni affichages d'état ni aides au montage !
ES	¡Los estribos de expulsión LZS:PT17021, LZS:PT17024 y LZS:RT17016 no son indicadores de estado o ayudas para el montaje!
IT	Le staffe di eiezione LZS:PT17021, LZS:PT17024 e LZS:RT17016 non sono indicatori di stato o accessori di montaggio.
PT	Os estribos ejetores LZS:PT17021, LZS:PT17024 e LZS:RT17016 não são displays de status ou auxílios de montagem!
TR	LZS:PT17021, LZS:PT17024 ve LZS:RT17016 dışarı atma askıları, durum göstergeleri ya da montaj yardımcıları değildir!
py	Скобы толкателя LZS: PT17021, LZS: PT17024 и LZS: RT17016 не являются индикацией состояния или приспособлением для монтажных работ!

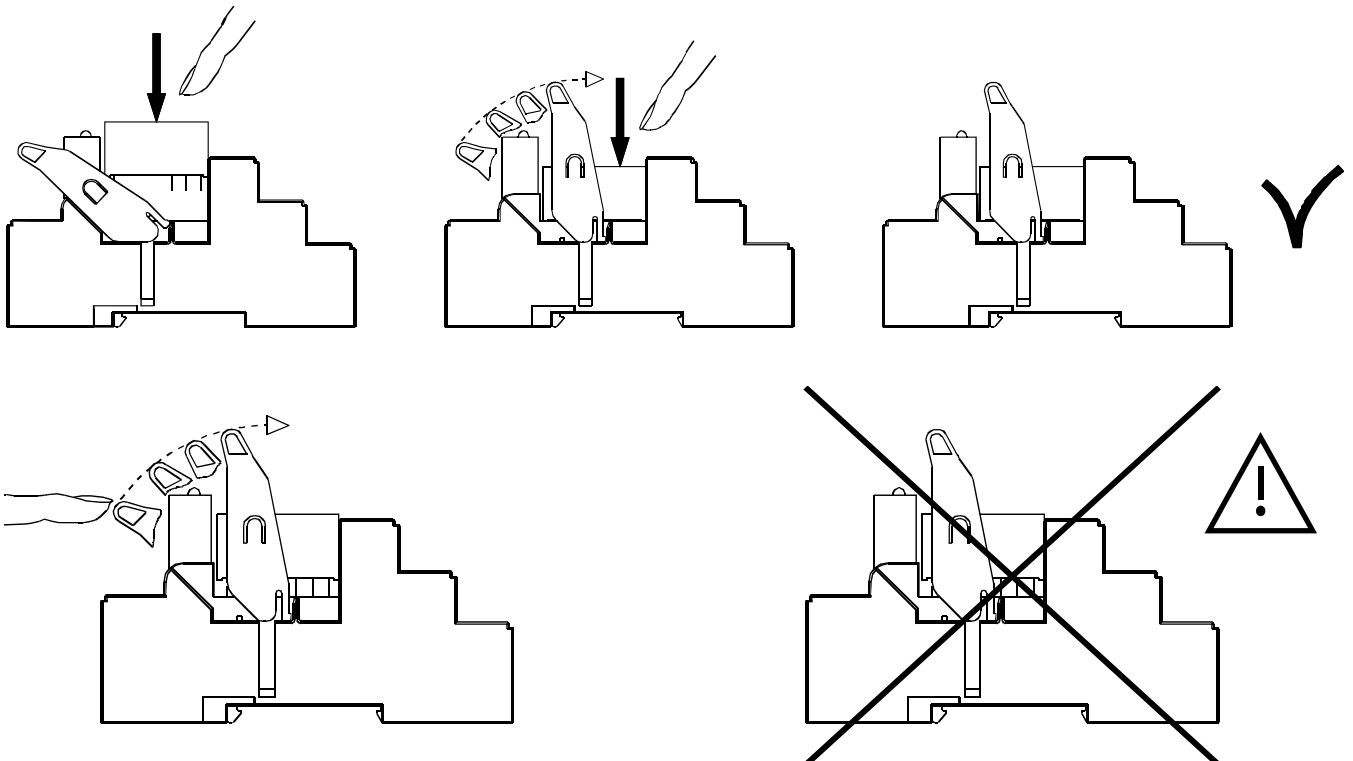

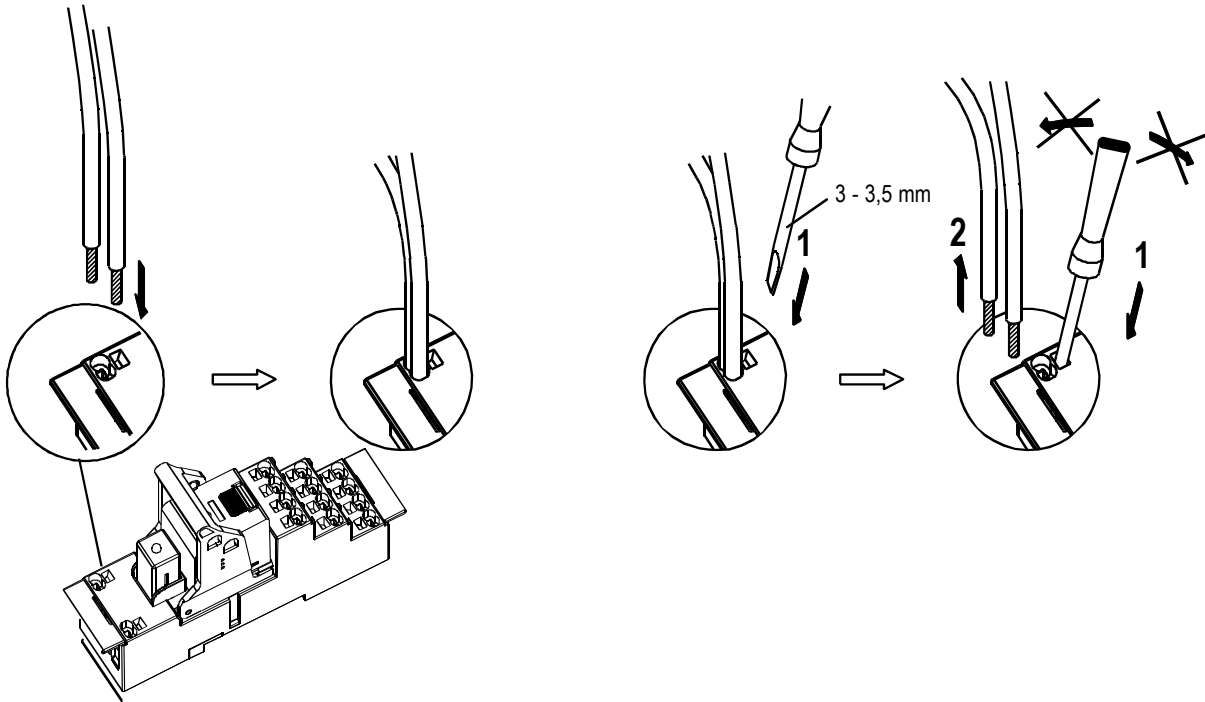

	LZS:PT.A/B. ... LZS:RT.A/B. ...	LZS:P.T.D. ... LZS:RT.D. ...
	 Ø 5 mm / PZ/H1 0,5 ... 0,7 Nm 4.4 ... 6.2 lbf · in	 Ø 3 ... 3,5 mm x 0,5 mm
	2 x 2,5 mm ²	1 x 0,75 ... 1,5 mm ² 2 x 0,75 ... 1,5 mm ²
	2 x 2,5 mm ²	1 x 0,75 ... 1,5 mm ² 2 x 0,75 ... 1,5 mm ²
	2 x 1,5 mm ²	1 x 0,75 ... 1,0 mm ² 2 x 0,75 mm ²
	2 x 1,5 mm ²	1 x 0,75 ... 1,0 mm ² 2 x 0,75 mm ²
	2 x 1,5 mm ²	1 x 1,5 mm ²
AWG	16 to 14	19 to 16

DE	Bei Litzen mit einem Geflecht von 0,05 mm oder kleiner sollten Aderendhülsen verwendet werden. Werden Litzen ohne Aderendhülsen verwendet, so muss die Klemme beim Einführen geöffnet sein.
EN	For stranded wires with braids 0.05 mm or smaller the use of bootlace crimps is recommended. When using stranded wires without bootlace crimp the clamp must be opened during insertion.
FR	Pour les fils torsadés à tresse de 0,05 mm ou inférieure à 0,05 mm, il est recommandé d'utiliser des embouts. Lors de l'utilisation de fils torsadés sans embout, la borne doit être ouverte pour l'insertion.
ES	Para conductores flexibles con un trenzado de 0,05 mm o inferior, se recomienda utilizar vainas terminales. Si se utilizan conductores flexibles sin vainas terminales, el borne debe estar abierto durante la entrada.
IT	Per le treccie con trecce da 0,05 mm o più piccole si consiglia l'utilizzo di aggraffature a laccio. Se si utilizzano treccie senza aggraffatura a laccio, il morsetto deve essere aperto durante l'inserimento.
PT	Para fios torcidos com um trançado de 0,05 mm ou menor é necessário utilizar terminais de fio. Se forem utilizados fios sem terminais de fio, o borne deve estar aberto durante a inserção.
TR	0,05 mm ya da daha küçük örgülü bükülü tellerde kablo yüksükleri kullanılması gerekmektedir. Kablo yüksüksüz bükülü teller kullanılması halinde, takarken klemensin açık olması gerekmektedir.
PY	Для многопроволочных кабелей с оплёткой 0,05 мм или менее необходимо использовать концевые гильзы жил. Если многопроволочные кабели используются без концевых гильз жил, клемма при вводе должна быть открытой.

Relais
 Relay
 Relais
 Relé
 Relé
 Rôle
 Pene

LZX:RT 3

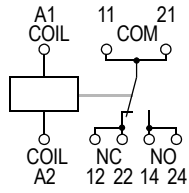

LZX:RT 4

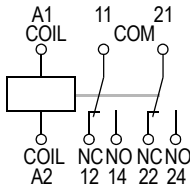

LZX:PT 270

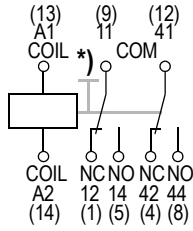

LZX:PT 370

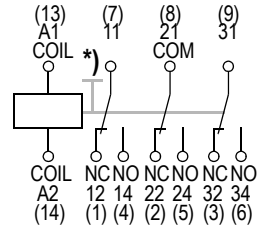

LZX:PT 520

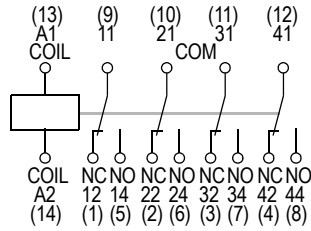

LZX:PT 570

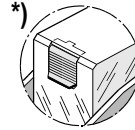
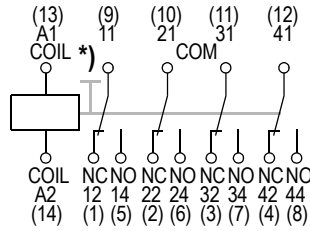

LZS:PT 270 / 370 / 570

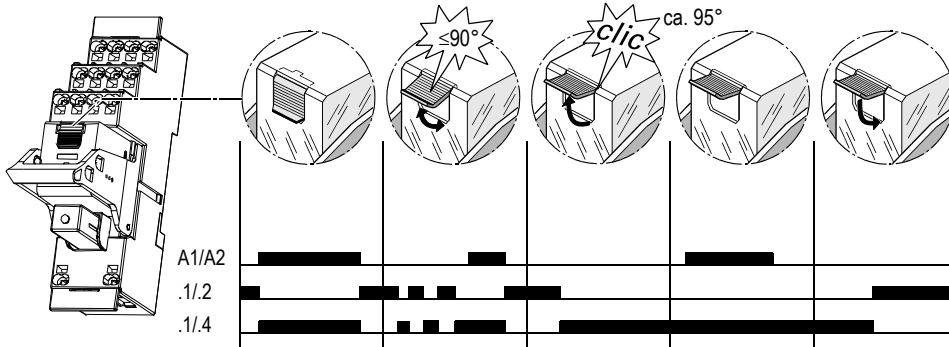

LZS:RT 3A4 / 4A4
 LZS:RT 78 725

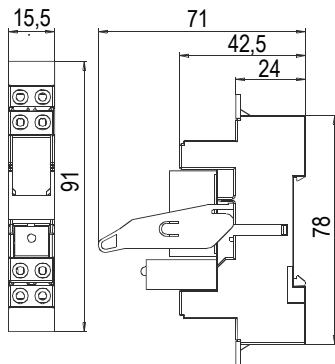

LZS:RT 3B4 / 4B4
 LZS:RT 78 726

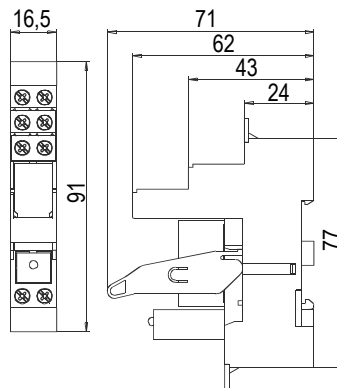

LZS:RT 3D4 / 4D4
LZS:RT 7872P

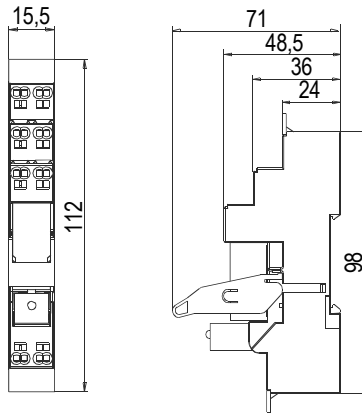

LZS:PT 3A5 LZS:PT 5A5
LZS:PT 78 730 LZS:PT 78 740

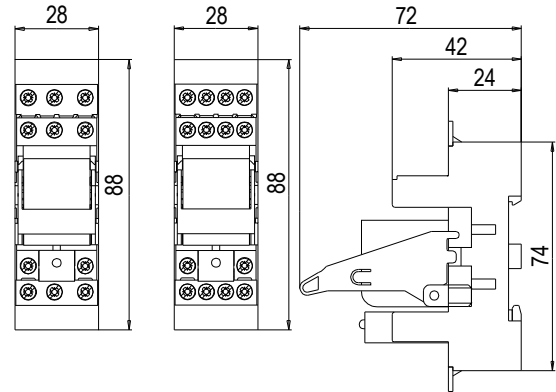

LZS:PT 5B5
LZS:PT 78 742

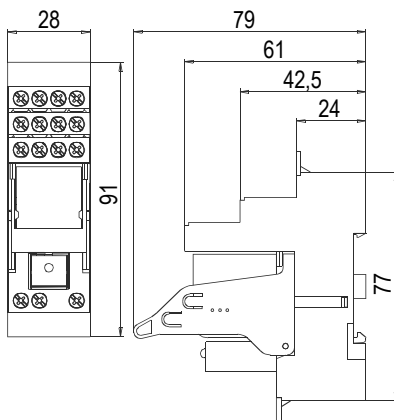

LZS:PT 5D5
LZS:PT 78 74P

