

SIRIUS

Halbleiterschütz
Semiconductor contactor
Contacteur statique
Contactor estático
Contattore a semiconduttore
Contator semiconductor

3RF24..-AB..
3RF24..-AC..



DIN EN 60 947-4-3

| Betriebsanleitung Instructivo | | Operating Instructions Istruzioni Operative | | Instructions de Service Instruções de Operação | |
|--|--|--|--|--|--|
| Deutsch | | English | | Français | |
| <p>Vor der Installation, dem Betrieb oder der Wartung des Geräts muss diese Anleitung gelesen und verstanden werden.</p> <p>Eine sichere Gerätefunktion ist nur mit zertifizierten Komponenten gewährleistet!</p> | | <p>Read and understand these instructions before installing, operating, or maintaining the equipment.</p> <p>Reliable functioning of the equipment is only ensured with certified components.</p> | | <p>Ne pas installer, utiliser ou intervenir sur cet équipement avant d'avoir lu et assimilé les présentes instructions et notamment les conseils de sécurité et mises en garde qui y figurent.</p> <p>La sécurité de fonctionnement de l'appareil n'est garantie qu'avec des composants certifiés.</p> | |
| ⚠ GEFAHR | | ⚠ DANGER | | ⚠ DANGER | |
| <p> Gefährliche Spannung. Lebensgefahr oder schwere Verletzungsgefahr. Vor Beginn der Arbeiten Anlage und Gerät spannungsfrei schalten.</p> | | <p>Hazardous voltage. Will cause death or serious injury. Turn off and lock out all power supplying this device before working on this device.</p> | | <p>Tension électrique. Danger de mort ou risque de blessures graves. Mettre hors tension avant d'intervenir sur l'appareil.</p> | |
| ⚠ GEFAHR | | ⚠ DANGER | | ⚠ DANGER | |
| <p> Gefährliche Spannung. Lebensgefahr oder schwere Verletzungsgefahr. Um elektrische Stromschläge oder Verbrennungen zu vermeiden, dürfen Sie die Klemmen des Halbleiterschützes nicht berühren, wenn an dessen Eingang Spannung liegt. Die Ausgangsklemme steht auch im AUS-Zustand des Halbleiterschützes unter Spannung (Leckstrom, Halbleiter durchlegiert).</p> | | <p>Hazardous voltage. Will cause death or serious injury. To avoid electric shock and burns, never touch the terminals of the semiconductor contactor if voltage is present at its input.</p> <p>The output terminal remains live even in the OFF state of the semiconductor contactor (leakage current, semiconductor breakdown).</p> | | <p>Tension dangereuse. Danger de mort ou risque de blessures graves. Ne pas toucher les bornes du relais statique lorsqu'une tension est appliquée à son entrée. Risque d'électrocution et de brûlure !</p> <p>La borne de sortie est aussi sous tension à l'état BLOQUE du relais statique (courant de fuite, semi-conducteur claqué).</p> | |
| Español | | Italiano | | Português | |
| <p>Leer y comprender este instructivo antes de la instalación, operación o mantenimiento del equipo.</p> <p>El funcionamiento seguro del aparato sólo está garantizado con componentes certificados.</p> | | <p>Leggere con attenzione queste istruzioni prima di installare, utilizzare o eseguire manutenzione su questa apparecchiatura.</p> <p>Il funzionamento sicuro dell'apparecchiatura è garantito soltanto con componenti certificati.</p> | | <p>Ler e compreender estas instruções antes da instalação, operação ou manutenção do equipamento.</p> <p>O funcionamento seguro do aparelho apenas pode ser garantido se forem utilizados os componentes certificados.</p> | |
| ⚠ PELIGRO | | ⚠ PERICOLO | | ⚠ PERIGO | |
| <p> Tensión peligrosa. Puede causar la muerte o lesiones graves. Desconectar la alimentación eléctrica antes de trabajar en el equipo.</p> | | <p>Tensione pericolosa. Può provocare morte o lesioni gravi. Scollegare l'alimentazione prima di eseguire interventi sull'apparecchiatura.</p> | | <p>Tensão perigosa. Perigo de morte ou ferimentos graves. Desligue a corrente antes de trabalhar no equipamento.</p> | |
| ⚠ PELIGRO | | ⚠ PERICOLO | | ⚠ PERIGO | |
| <p> Tensión peligrosa. Puede causar la muerte o lesiones graves. Para evitar choques eléctricos o quemaduras no se deberán tocar los bornes del relé estático cuando su entrada esté bajo tensión. El borne de salida está también bajo tensión incluso si el relé estático se encuentra en estado DES (por causa de corriente de fuga o cortocircuito interno del semiconductor).</p> | | <p>Tensione pericolosa. Può provocare morte o lesioni gravi. Per evitare shock elettrici e ustioni, non toccare i morsetti del relè statici quando il suo ingresso è sotto tensione.</p> <p>Il morsetto di uscita è sotto tensione anche quando il relè statici è disinserito (corrente di dispersione, semiconduttore in cortocircuito).</p> | | <p>Tensão perigosa. Perigo de morte ou ferimentos graves. De modo a evitar choques eléctricos ou queimaduras não pode tocar nos bornes do relé semiconductor se a entrada do mesmo estiver sob tensão.</p> <p>O borne de saída está sob tensão, mesmo quando o relé semiconductor estiver em estado DESLIGADO (corrente de fuga, semiconductor com liga).</p> | |

| DE | EN | FR | ES | IT | PT |
|-----------|--------------------|-------------|------------------|-----------------|-----------------------|
| Maßbilder | Dimension drawings | Encombremet | Croquis acotados | Disegni quotati | Desenhos dimensionais |

**3RF2410-AB.., 3RF2410-AC..,
3RF2420-AB.., 3RF2420-AC..,
3RF2430-AB..**

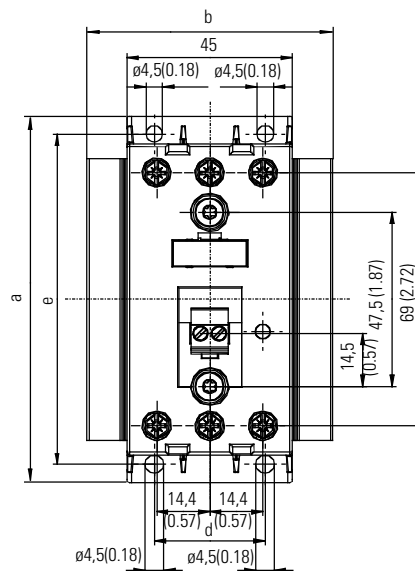
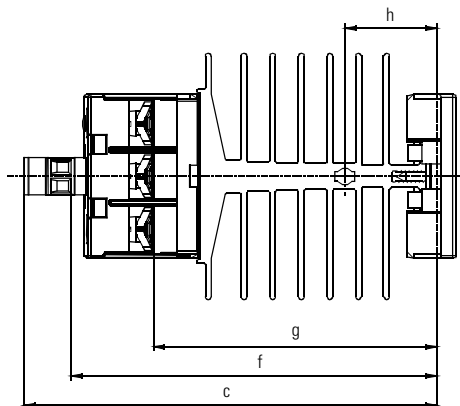

**3RF2430-AC..
3RF2440-AB.., 3RF2440-AC..,
3RF2450-AB.., 3RF2450-AC..**

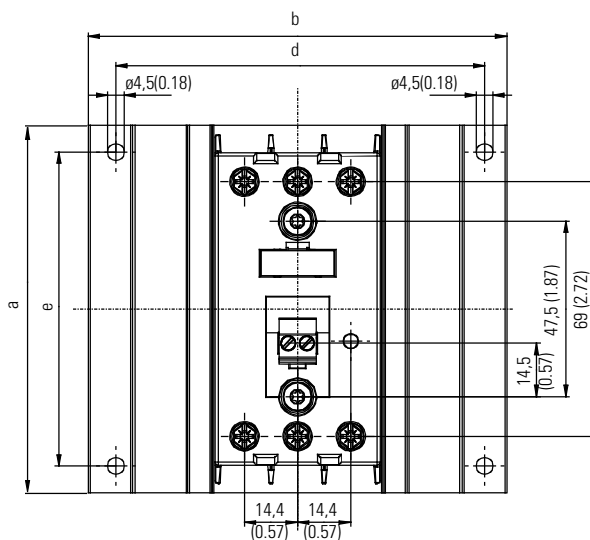
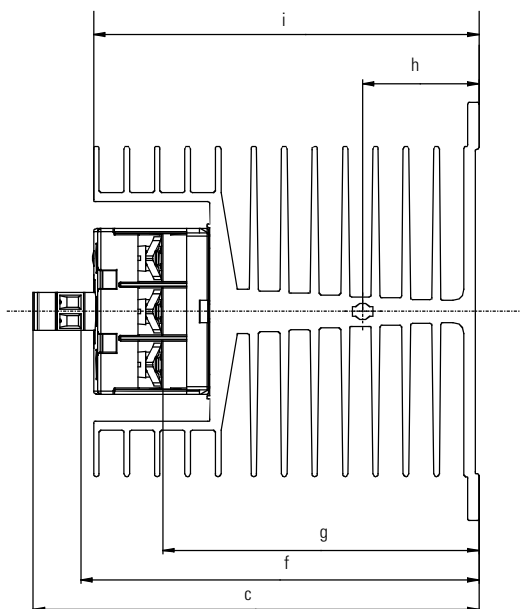

| | a | b | c | d | e | f | g | h | i |
|------------------------------|------------|--------------|--------------|------------|------------|-------------|-------------|-------------|--------------|
| 3RF2410-AC.. 3RF2410-AB.. | 100 (3.94) | 45 (1.77) | 104,5 (4.11) | 30 (1.18) | 90 (3.54) | 91,5 (3.60) | 69,5 (2.74) | 25 (0.98) | — |
| 3RF2420-AB.. | 100 (3.94) | 67 (2.64) | 112,5 (4.43) | 30 (1.18) | 90 (3.54) | 99,5 (3.92) | 77 (3.03) | 25 (0.98) | — |
| 3RF2420-AC.. 3RF2430-AB.. | 100 (3.94) | 89,5 (3.52) | 112,5 (4.43) | 30 (1.18) | 90 (3.54) | 99,5 (3.92) | 77 (3.03) | 25 (0.98) | — |
| 3RF2430-AC.. 3RF2440-AB.. | 100 (3.94) | 113,5 (4.47) | 121 (4.76) | 100 (3.94) | 85 (3.35) | 108 (4.25) | 86 (3.39) | 31,5 (1.24) | 104,5 (4.11) |
| 3RF2440-AC.. 3RF2450-AB.. | 100 (3.94) | 157,5 (6.20) | 121 (4.76) | 146 (5.75) | 80 (3.15) | 108 (4.25) | 86 (3.39) | 31,5 (1.24) | 104,5 (4.11) |
| 3RF2450-AC.. | 180 (7.09) | 157,5 (6.20) | 121 (4.76) | 146 (5.75) | 160 (6.30) | 108 (4.25) | 86 (3.39) | 31,5 (1.24) | 104,5 (4.11) |

| DE | EN | FR | ES | IT | PT |
|---------|----------|---------|---------|-----------|----------|
| Montage | Assembly | Montage | Montaje | Montaggio | Montagem |

**3RF2410-AB.., 3RF2410-AC..,
3RF2420-AB.., 3RF2420-AC..,
3RF2430-AB..**

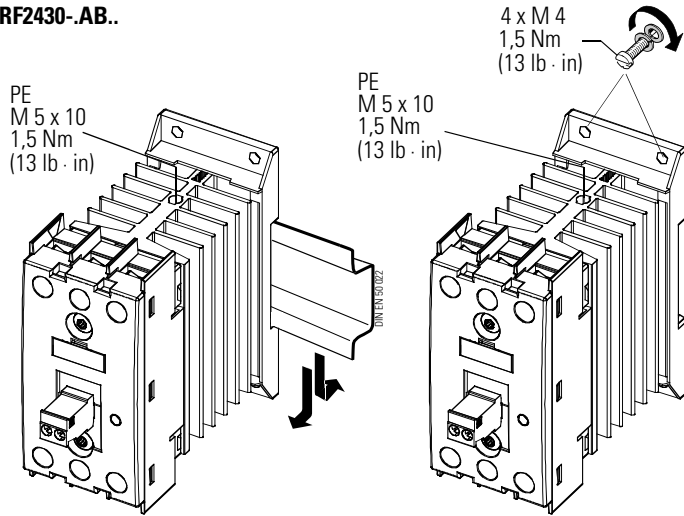

**3RF2430-AC..
3RF2440-AB.., 3RF2440-AC..,
3RF2450-AB.., 3RF2450-AC..**

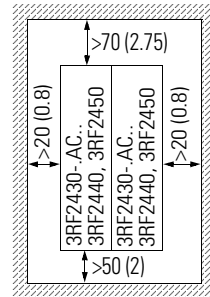
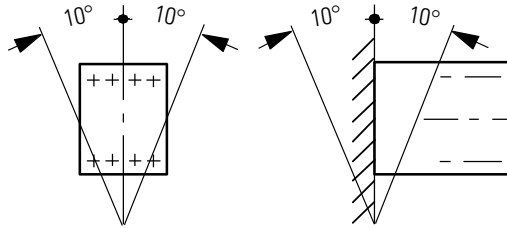
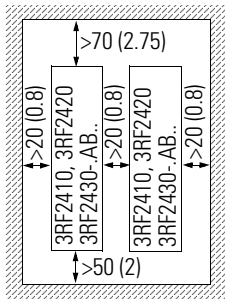
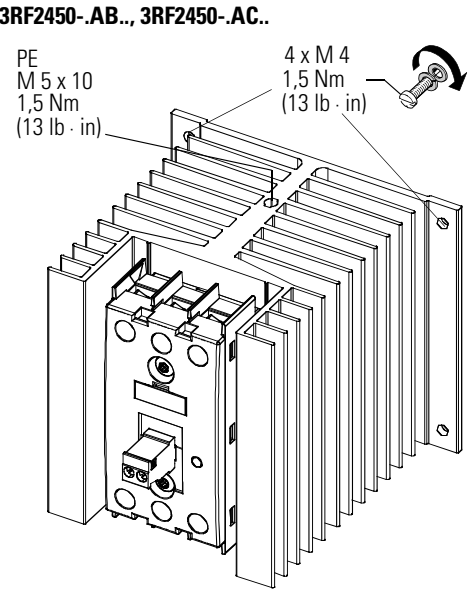

| DE | EN | FR | ES | IT | PT |
|-----------|------------|-----------|----------|------------|---------|
| Anschluss | Connection | Connexion | Conexión | Connettore | Conexão |

3RF24..-1

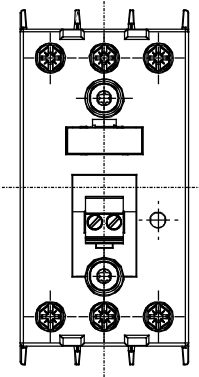



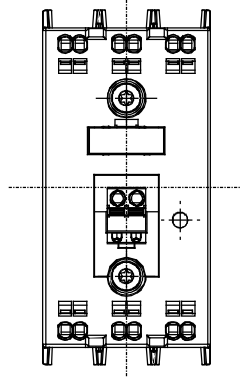



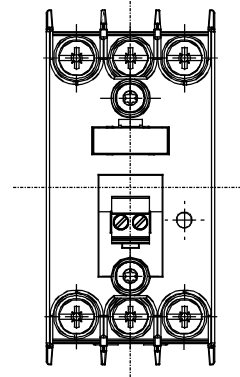



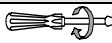
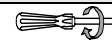

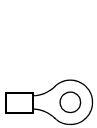

3RF24..-2



3RF24..-3



| DE | EN | FR | ES | IT | PT |
|---|---|---|--|--|--|
| Anschlussquerschnitte und Anzugsdrehmomente | Conductor cross-sections and tightening torques | Section des conducteurs de raccordement et couples de serrage | Secciones de cables de conexión y pares de apriete | Sezioni dei conduttori di collegamento e coppie di serraggio | Seções transversais de conexão e torques de aperto |

| | 3RF24..-1 | | | 3RF24..-2 | | | 3RF24..-3 | |
|---|--|--|---|---------------------------------|---------------------------------|---|--|--|
| | L1 - T3 | A1 - A2 | | L1 - T3 | A1 - A2 | | L1 - T3 | A1 - A2 |
|  Ø 5 ... 6 mm / PZ2 | 2 ... 2,5 Nm 18 ... 22 lbf · in | — | — | — | — |  Ø 5 ... 6 mm / PZ2 | 2 ... 2,5 Nm 18 ... 22 lbf · in | — |
|  | 2 x 1,5 ... 2,5 mm ² 2 x 2,5 ... 6 mm ² | |  | 2 x 0,5 ... 2,5 mm ² | |  | DIN 46234 5 - 2,5 ... 5 - 16 | |
|  | 2 x 1,5 ... 2,5 mm ² 2 x 2,5 ... 6 mm ² 1 x 10 mm ² | |  | 2 x 0,5 ... 1,5 mm ² | |  | JIS C 2805 R 2 - 5 ... 14 - 5 | |
| AWG | 2 x 14 ... 10 | | AWG | 2 x 18 ... 14 | | AWG | | |
|  Ø 3,5 mm / PZ1 | — | 0,5 ... 0,6 Nm 4,5 ... 5,3 lbf · in | — | — | — |  Ø 3,5 mm / PZ1 | 0,5 ... 0,6 Nm 4,5 ... 5,3 lbf · in | — |
|  | — | 1 x 0,5 ... 2,5 mm ² 2 x 0,5 ... 1 mm ² |  | — | 1 x 0,5 ... 2,5 mm ² |  | — | 1 x 0,5 ... 2,5 mm ² 2 x 0,5 ... 1 mm ² |
|  | — | 1 x 0,5 ... 2,5 mm ² 2 x 0,5 ... 1 mm ² |  | — | 1 x 0,5 ... 2,5 mm ² |  | — | 1 x 0,5 ... 2,5 mm ² 2 x 0,5 ... 1 mm ² |
| AWG | — | 1 x 20 ... 12 | AWG | — | 1 x 20 ... 12 | AWG | — | 1 x 20 ... 12 |

| DE | EN | FR | ES | IT | PT |
|------------------|-----------------|------------------|-------------------|------------------|---------------------|
| Schaltungsskizze | Circuit diagram | Schéma intérieur | Esquema eléctrico | Schema elettrico | Esquema do circuito |

3RF24..-AB4.

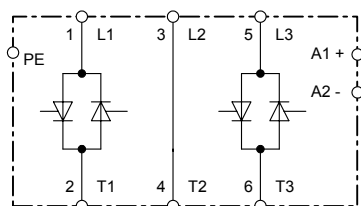

DC 4 ... 30 V

3RF24..-AB3.

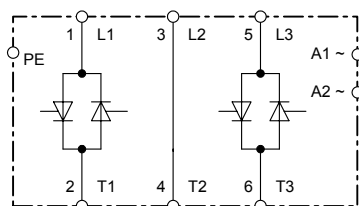

AC 110 V

3RF24..-AB5.

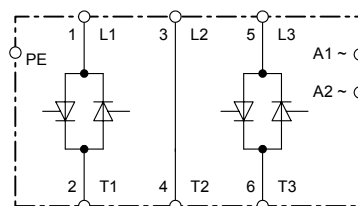

AC 230 V

3RF24..-AC4.

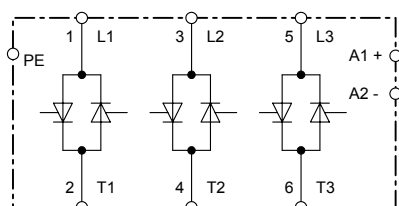

DC 4 ... 30 V

3RF24..-AC3.

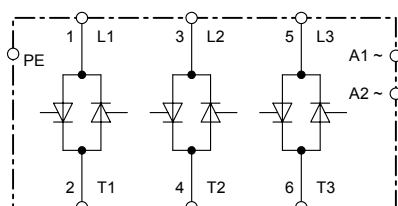

AC 110 V

3RF24..-AC5.

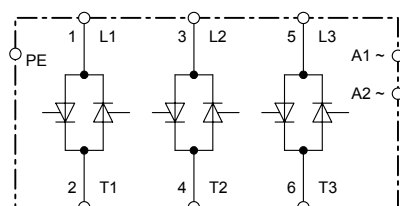

AC 230 V

Technical Assistance: Telephone: +49 (0) 911-895-5900 (8⁰⁰ - 17⁰⁰ CET)
E-mail: technical-assistance@siemens.com
Internet: www.siemens.de/lowvoltage/technical-assistance

Technical Support: Telephone: +49 (0) 180 50 50 222

Fax: +49 (0) 911-895-5907

Technische Änderungen vorbehalten. Zum späteren Gebrauch aufbewahren.
Subject to change without prior notice. Store for use at a later date.
© Siemens AG 2005

Bestell-Nr./Order No.: 3ZX1012-0RF24-2AA1
Printed in the Federal Republic of Germany